



PROGRAMMABLE CONTROLLERS
MELSEC-F

FX3U-64CCL INSTALLATION MANUAL



Manual Number	JY997D29801
Revision	D
Date	April 2015

This manual describes the part names, dimensions, and specifications of the product. Before use, read this manual and manuals of relevant products fully to acquire proficiency in handling and operating the product. Make sure to learn all the product information, safety information, and precautions.

And, store this manual in a safe place so that you can take it out and read it whenever necessary. Always forward it to the end user.

Registration
The company name and the product name to be described in this manual are the registered trademarks or trademarks of each company.

Effective April 2015
Specifications are subject to change without notice.
© 2008 Mitsubishi Electric Corporation

Safety Precaution (Read these precautions before use.)

This manual classifies the safety precautions into two categories:

WARNING and **CAUTION**.

WARNING	Indicates that incorrect handling may cause hazardous conditions, resulting in death or severe injury.
CAUTION	Indicates that incorrect handling may cause hazardous conditions, resulting in medium or slight personal injury or physical damage.

Depending on circumstances, procedures indicated by **CAUTION** may also cause severe injury. It is important to follow all precautions for personal safety.

Associated Manuals

Manual name	Manual No.	Description
FX3G Series User's Manual - Hardware Edition	JY997D31301 MODEL CODE: 09R521	Explains the FX3G Series PLC specifications for I/O, wiring, installation, and maintenance.
FX3U Series User's Manual - Hardware Edition	JY997D16501 MODEL CODE: 09R516	Explains the FX3U Series PLC specifications for I/O, wiring, installation, and maintenance.
FX3UC Series User's Manual - Hardware Edition	JY997D28701 MODEL CODE: 09R519	Explains the FX3UC Series PLC specifications for I/O, wiring, installation, and maintenance.
FX3S/FX3G/FX3GC/FX3U/FX3UC Series Programming Manual - Basic & Applied Instruction Edition	JY997D16601 MODEL CODE: 09R517	Describes PLC programming for basic/applied instructions and devices.
FX3U-64CCL User's Manual	JY997D30401 MODEL CODE: 09R718	Describes FX3U-64CCL type CC-Link interface block details.

Manuals for the FX3G PLC will be available in September 2008 or later.

How to obtain manuals

For product manuals or documents, contact the Mitsubishi Electric dealer from whom you purchased your product.

Certification of UL, cUL standards

FX3U-64CCL units comply with the UL standards (UL, cUL).
UL, cUL File Number: E95239

Regarding the standards that comply with the main unit, please refer to either the FX series product catalog or consult with your nearest Mitsubishi product provider.

Compliance with EC directive (CE Marking)

This note does not guarantee that an entire mechanical module produced in accordance with the contents of this note will comply with the following standards. Compliance to EMC directive and LVD directive for the entire mechanical module should be checked by the user / manufacturer. For more information please consult with your nearest Mitsubishi product provider.

Regarding the standards that comply with the main unit, please refer to either the FX series product catalog or consult with your nearest Mitsubishi product provider.

Requirement for Compliance with EMC directive

The following products have shown compliance through direct testing (of the identified standards below) and design analysis (through the creation of a technical construction file) to the European Directive for Electromagnetic Compatibility (2004/108/EC) when used as directed by the appropriate documentation.

Attention

- This product is designed for use in industrial applications.

Note

- Authorized Representative in the European Community:
Mitsubishi Electric Europe B.V.
Gothaer Str. 8, 40880 Ratingen, Germany

Type: Programmable Controller (Open Type Equipment)
Models: MELSEC FX3U series manufactured from March 1st, 2008 FX3U-64CCL

Standard	Remark
EN61131-2:2007 Programmable controllers - Equipment requirements and tests	Compliance with all relevant aspects of the standard. EMI • Radiated Emissions • Conducted Emissions EMS • Radiated electromagnetic field • Fast Transient burst • Electrostatic discharge • High-energy surge • Voltage drops and interruptions • Conducted RF • Power frequency magnetic field

Caution for EC Directive

- Installation in Enclosure
Programmable logic controllers are open-type devices that must be installed and used within conductive control cabinets. Please use the programmable logic controller while installed within a conductive shielded control cabinet. Please secure the cabinet door to the control cabinet (for conduction). Installation within a control cabinet greatly affects the safety of the system and aids in shielding noise from the programmable logic controller.

- Control cabinet
 - The control cabinet must be conductive.
 - Ground the control cabinet with the thickest possible grounding cable.
 - To ensure that there is electric contact between the control cabinet and its door, connect the cabinet and its doors with thick wires.
 - In order to suppress the leakage of radio waves, the control cabinet structure must have minimal openings. Also, wrap the cable holes with a shielding cover or other shielding devices.
 - The gap between the control cabinet and its door must be as small as possible by attaching EMI gaskets between them.

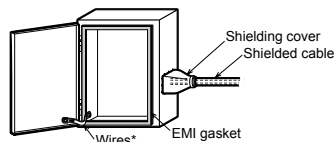

* These wires are used to improve the conductivity between the door and control cabinet.

- Configuration example inside control cabinet

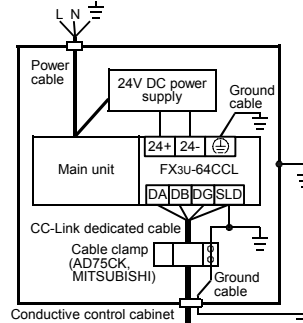

- Wiring simplified diagram

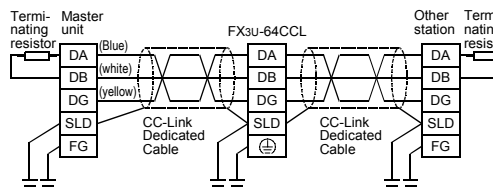

- Notes for compliance with EN61131-2:2007

- General notes on the use of the power supply cable
- The FX3U-64CCL unit requires that the cable used for power supply is 30m or less.
 - When the cable used for power supply exceeds 30m, a noise filter (Ex. DENSEI-LAMBDA MBS1205-22 or similar) should be placed on the 24V DC power cabling as close (within 500mm) to the FX3U-64CCL termination points as possible, refer to following figure.

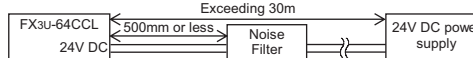

1. Introduction

The CC-Link interface block FX3U-64CCL (hereinafter called 64CCL) is a special function block to connect the FX3G/FX3U/FX3UC Series programmable logic controller to a CC-Link network.

The 64CCL works as an intelligent device station on a CC-Link network.

Only one 64CCL unit can be connected to a single programmable logic controller main unit.

→ For system configuration, refer to the FX3U-64CCL User's Manual.

1.1 Major Features of the FX3U-64CCL

- Compatible with CC-Link Ver. 2.00 and Ver. 1.10
The 64CCL is compatible with CC-Link Ver. 2.00, and enables expanded cyclic transmission to facilitate the handling of applications requiring multiple data processing.
In addition to Ver. 2.00, Ver. 1.10 is also supported with the 64CCL.

1.2 Incorporated Items

Check to ensure the following product and items are included in the package:

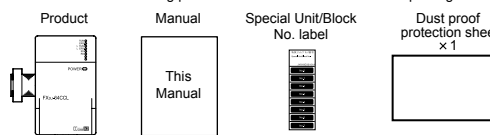

1.3 External Dimensions and Part Names

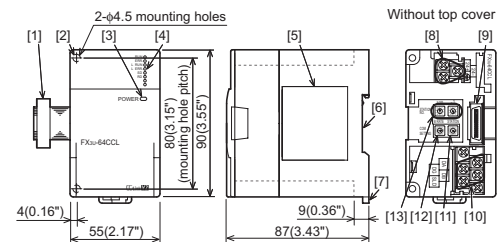

Unit: mm (inches)
MASS (Weight): 0.3kg (0.66lbs)

- Extension cable
- Direct mounting hole: 2 holes of $\phi 4.5$ (0.18") (mounting screw: M4 screw)
- POWER LED (green)
- Status LEDs
- Name plate
- DIN rail mounting groove (DIN rail: DIN46277, 35mm (1.38") width)
- DIN rail mounting hook
- Power supply terminal block
- Extension connector
- CC-Link connection terminal block
- Number of occupied stations and expanded cyclic setting switch
- Transmission rate setting switch
- Station number setting switch

1.4 Power and status LEDs

LED display	Color	Status	Description
POWER	Green	OFF	Power is not being supplied from the external power supply (24V DC).
		ON	Power is being supplied from the external power supply (24V DC).
RUN	Green	OFF	64CCL has failed.
		ON	Under 64CCL normal operation.
ERR.	Red	OFF	No errors.
		ON	Error in the settings, error in the parameter details, error with the communication, errors with the H/W.
L RUN	Green	OFF	Offline.
		ON	Data link is being executed.
L ERR.	Red	OFF	No communication error.
		Flicker	The switch setting was changed after start. There is no terminating resistor. Influence from noise.
		ON	There is a data linking error. There is a setting error.
SD	Green	OFF	Data is not being sent.
		ON	Data is being sent.
RD	Green	OFF	Data is not being received.
		ON	Data is being received.

1.5 Terminal layout

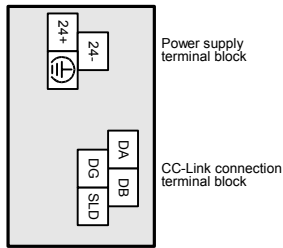

- Terminal screw and terminal block mounting screw size, and tightening torque
Power supply terminal block, CC-Link connection terminal block:
M3 screw, 42 to 58 N•cm
CC-Link connection terminal block mounting screw (black):
M3.5 screw, 66 to 91 N•cm

CC-Link connection terminal block can be detached or attached. Make sure to cut off all phases of the power supply externally.

For details on the wiring and the types of connection cables needed to connect to the terminal blocks shown in the figure above, refer to the following manual.
→ Refer to the FX3U-64CCL User's Manual.

1.6 Switch setting

With regard to the switch setting for station number, transmission rate, hardware test, number of occupied stations and expanded cyclic transmission, the switch settings become valid after 64CCL startup.
If the switch settings are changed after 64CCL startup, the L.ERR.LED will flicker. To change the switch setting, power OFF the 64CCL once, and power it ON again. For details on the switch setting, refer to the following manual.
→ Refer to the FX3U-64CCL User's Manual.

1.6.1 Station number setting

Setting items	Range	Description
× 10	0 to 6	1 to 64
× 1	0 to 9	0, 65 to 99 is the setting error.

1.6.2 Transmission rate setting, hardware test

Setting	Description	Status
0	Transmission rate 156Kbps	Online
1	Transmission rate 625Kbps	
2	Transmission rate 2.5Mbps	
3	Transmission rate 5Mbps	
4	Transmission rate 10Mbps	Hardware test
5 to 9	Unusable	
A	Transmission rate 156Kbps	
B	Transmission rate 625Kbps	
C	Transmission rate 2.5Mbps	
D	Transmission rate 5Mbps	
E	Transmission rate 10Mbps	Unusable
F	Unusable	

1.6.3 Number of occupied stations, expanded cyclic setting

Setting	Number of occupied stations	Expanded cyclic setting
0	1 station	Single
1	2 stations	Single
2	3 stations	Single
3	4 stations	Single
4	1 station	Double
5	2 stations	Double
6	3 stations	Double
7	4 stations	Double
8	1 station	Quadruple
9	2 stations	Quadruple
A, B	Unusable	Unusable
C	1 station	Octuple
D to F	Unusable	Unusable

2. Installation

INSTALLATION PRECAUTIONS	⚠ WARNING
<ul style="list-style-type: none"> Make sure to cut off all phases of the power supply externally before attempting installation work. Failure to do so may cause electric shock or damage to the product. 	

INSTALLATION PRECAUTIONS	⚠ CAUTION
<ul style="list-style-type: none"> Use the product within the generic environment specifications described in PLC main unit manual (Hardware Edition). Never use the product in areas with excessive dust, oily smoke, conductive dusts, corrosive gas (sulfur acid, Cl₂, H₂S, SO₂, or NO₂), flammable gas, vibration or impacts, or expose it to high temperature, condensation, or rain and wind. If the product is used in such conditions, electric shock, fire, malfunctions, deterioration or damage may occur. Do not touch the conductive parts of the product directly. Doing so may cause device failures or malfunctions. Install the product securely using a DIN rail or mounting screws. Install the product on a flat surface. If the mounting surface is rough, undue force will be applied to the PC board, thereby causing nonconformities. When drilling screw holes or wiring, make sure that cutting and wiring debris do not enter the ventilation slits. Failure to do so may cause fire, equipment failures or malfunctions. Be sure to remove the dust proof sheet from the PLC's ventilation port when installation work is completed. Failure to do so may cause fire, equipment failures or malfunctions. Make sure to attach the top cover, offered as an accessory, before turning on the power or initiating operation after installation or wiring work. Failure to do so may cause electric shock. Connect extension cables securely to their designated connectors. Loose connections may cause malfunctions. 	

For details on anchoring, refer to the following manual.

→ Refer to the FX3U-64CCL User's Manual.

2.1 Connection with PLC

Only one 64CCL can be connected to the right side of a PLC main unit or extension unit/block (including special function units/blocks).
For connection to an FX3UC Series PLC or FX2NC Series PLC extension block, an FX2NC-CNV-IF or FX3UC-1PS-5V is required.

For further information on installation arrangements, refer to the following manuals.

→ Refer to the FX3G Series User's Manual - Hardware Edition.

→ Refer to the FX3U Series User's Manual - Hardware Edition.

→ Refer to the FX3UC Series User's Manual - Hardware Edition.

2.2 Mounting

The product is mounted by the following method.

- DIN rail mounting
- Direct mounting (mounting screw: M4 screw)

For further information on installation arrangements, refer to the following manuals.

→ Refer to the FX3G Series User's Manual - Hardware Edition.

→ Refer to the FX3U Series User's Manual - Hardware Edition.

→ Refer to the FX3UC Series User's Manual - Hardware Edition.

2.2.1 DIN Rail Mounting

The product can be mounted on a DIN rail (DIN46277, 35mm (1.38") width).

- Fit the upper edge of the DIN rail mounting groove (fig. A) onto the DIN rail.
- Press the product against the DIN rail.

- An interval space of 1 to 2 mm (0.04" to 0.08") between each unit is necessary.

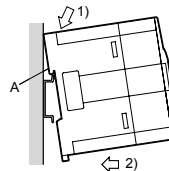

2.2.2 Direct Mounting (mounting screw: M4 screw)

The product can be installed directly with screws.

Refer to the External Dimensions (section 1.3) for the product's mounting hole pitch information.

An interval space between each unit of 1 to 2 mm (0.04" to 0.08") is necessary.

3. Specification

For details on specifications, refer to the following manual.

→ Refer to the FX3U-64CCL User's Manual.

DESIGN PRECAUTIONS	⚠ WARNING
<ul style="list-style-type: none"> For the status of each station when the main unit stops calculation or when a communication error occurs in the data link, thoroughly read the description of data link processing time in the CC-Link master module manual. Construct an interlock circuit in the sequence program using the communication status information (BFM, SB, SW) so that the system always works conservatively. Erroneous outputs and malfunctions may cause accidents. 1) Setting to hold or clear the input information against data link error Remote outputs (RY) and remote registers (RWw) are held or cleared in accordance with the setting of BFM #32. 0 (default): Data prior to the error is held. Other than 0: Data prior to the error is cleared. 2) Setting to hold or clear the data against a stop in the main unit Remote inputs (RX) and remote registers (RWr) are held or cleared in accordance with the setting of BFM #33. 0 (default): Data prior to the error is held. Other than 0: Data prior to the stop is cleared. When executing control (data changes) to an operating PLC, construct an interlock circuit in the sequence program so that the entire system operates conservatively. In addition, when executing control such as program changes and operation status changes (status control) to an operating PLC, thoroughly read the manual and sufficiently confirm safety in advance. Especially in control from external equipment to a PLC in a remote place, problems in the PLC may not be able to be handled promptly due to abnormality in data transfer. Construct an interlock circuit in the sequence program. At the same time, determine the actions in the system between the external equipment and the PLC (Master station contains) for protection against abnormalities in data transfer. Make sure to include the following safety circuits outside the PLC to ensure safe system operation even during external power supply problems or PLC failure. Otherwise, malfunctions may cause serious accidents. Above all, the following components should be included: an emergency stop circuit, a protection circuit, an interlock circuit for opposite movements (such as normal vs. reverse rotation), and an interlock circuit (to prevent damage to the equipment at the upper and lower positioning limits). Note that when the PLC main unit detects an error during self diagnosis, such as a watchdog timer error, all outputs are turned off. Also, when an error that cannot be detected by the PLC main unit occurs in an input/output control block, output control may be disabled. External circuits and mechanisms should be designed to ensure safe machinery operation in such cases. 	

DESIGN PRECAUTIONS	⚠ CAUTION
<ul style="list-style-type: none"> Observe the following items. Failure to do so may cause incorrect data-writing through noise to the PLC and result in PLC failure, machine damage or other accident. 1) Do not bundle the control line together with or lay it close to the main circuit or power line. As a guideline, lay the control line at least 100mm (3.94") or more away from the main circuit or power line. Noise may cause malfunctions. 2) Ground the shield wire or shield of a shielded cable. Do not use common grounding with heavy electrical systems. Do not apply excessive pressure to the power supply terminal block or CC-Link connection terminal block. Excessive pressure may cause damage or error. 	

DISPOSAL PRECAUTIONS	⚠ CAUTION
<ul style="list-style-type: none"> Please contact a certified electronic waste disposal company for the environmentally safe recycling and disposal of your device. 	

TRANSPORT AND STORAGE PRECAUTIONS	⚠ CAUTION
<ul style="list-style-type: none"> The PLC is a precision instrument. During transportation, avoid impacts larger than those specified in the general specifications of the PLC main unit manual. Failure to do so may cause failures in the PLC. After transportation, verify the operations of the PLC. 	

3.1 Applicable PLC

Model name	Applicability
FX3G Series PLC	Ver. 1.00 (from the first product) and later Only one 64CCL unit can be connected in a main unit.
FX3U Series PLC	Ver. 2.20 (from the first product) and later Only one 64CCL unit can be connected in a main unit.
FX3UC Series PLC*1	Ver. 2.20 (from products manufactured in May, 2005 with SER No. 55****) and later Only one 64CCL unit can be connected in a main unit.

The version number can be checked by monitoring the last three digits of D8001.

*1 An FX2NC-CNV-IF or FX3UC-1PS-5V is necessary to connect the 64CCL with the FX3UC PLC.

3.2 General Specifications

Items other than the following are equivalent to those of the PLC main unit.

For general specifications, refer to the manual of the PLC main unit.

→ Refer to the FX3G Series User's Manual - Hardware Edition.

→ Refer to the FX3U Series User's Manual - Hardware Edition.

→ Refer to the FX3UC Series User's Manual - Hardware Edition.

Item	Specification	
Dielectric withstand voltage	500V AC for one minute	Conforming to JEM-1021
Insulation resistance	5MΩ or more by 500V DC megger	Between all terminals and ground terminal

3.3 Power Supply Specification

Item	Specification	
External power supply	Power supply voltage	24V DC +20% -15% Ripple (p-p) within 5%
	Permitted instantaneous power failure time	Operation continues when the instantaneous power failure is shorter than PS1:1ms.
	Current consumption	220mA

3.4 Performance Specification

Item	Specification
CC-Link applicable version	Ver.2.00 (Ver.1.10 also supported.)*1
Station type	Intelligent device station
Station number	1 to 64
Transmission rate	156Kbps/625Kbps/2.5Mbps/5Mbps/10Mbps
Transmission distance	In accordance with the CC-Link specification. Refer to the PLC main unit manual for details.
Number of occupied stations	1 to 4 stations
Setting items	Station number, Transmission rate, Number of occupied stations, Expanded cyclic setting
Connection cable	CC-Link dedicated cable/ CC-Link dedicated high-performance cable/ Ver.1.10 compatible CC-Link dedicated cable
Number of I/O occupied points	8 points
Number of connectable units to the main unit	1

*1 When the setting of the 64CCL is the single setting, please set up the master station as a Ver.1 intelligent device station. When the setting of the 64CCL are the double setting, the quadruple setting, or the octuple setting, please set up the master station as a Ver.2 intelligent device station.

This manual confers no industrial property rights or any rights of any other kind, nor does it confer any patent licenses. Mitsubishi Electric Corporation cannot be held responsible for any problems involving industrial property rights which may occur as a result of using the contents noted in this manual.

Warranty

Mitsubishi will not be held liable for damage caused by factors found not to be the cause of Mitsubishi; opportunity loss or lost profits caused by faults in the Mitsubishi products; damage, secondary damage, accident compensation caused by special factors unpredictable by Mitsubishi; damages to products other than Mitsubishi products; and to other duties.

⚠ For safe use
<ul style="list-style-type: none"> This product has been manufactured as a general-purpose part for general industries, and has not been designed or manufactured to be incorporated in a device or system used in purposes related to human life. Before using the product for special purposes such as nuclear power, electric power, aerospace, medicine or passenger movement vehicles, consult with Mitsubishi Electric. This product has been manufactured under strict quality control. However when installing the product where major accidents or losses could occur if the product fails, install appropriate backup or failsafe functions in the system.

MITSUBISHI ELECTRIC CORPORATION

HEAD OFFICE : TOKYO BUILDING, 2-7-3 MARUNOUCHI, CHIYODA-KU, TOKYO 100-8310, JAPAN



FX3U-64CCL INSTALLATION MANUAL



Table with Manual Number, Revision, Date

This manual describes the part names, dimensions, and specifications of the product. Before use, read this manual and manuals of relevant products fully to acquire proficiency in handling and operating the product.

Effective April 2015 Specifications are subject to change without notice.

Safety Precaution (Read these precautions before use.)

This manual classifies the safety precautions into two categories:

WARNING and CAUTION

Warning and Caution boxes with icons and text describing hazardous conditions.

Depending on circumstances, procedures indicated by CAUTION may also cause severe injury. It is important to follow all precautions for personal safety.

Associated Manuals

Table listing associated manuals like FX3G Series, FX3U Series, FX3UC Series, FX3S/FX3G/FX3GC/FX3U/FX3UC Series, and FX3U-64CCL User's Manual.

Manuals for the FX3G PLC will be available in September 2008 or later.

How to obtain manuals

For product manuals or documents, contact the Mitsubishi Electric dealer from whom you purchased your product.

Certification of UL, cUL standards

FX3U-64CCL units comply with the UL standards (UL, cUL).

UL, cUL File Number: E95239

Regarding the standards that comply with the main unit, please refer to either the FX series product catalog or consult with your nearest Mitsubishi product provider.

Compliance with EC directive (CE Marking)

This note does not guarantee that an entire mechanical module produced in accordance with the contents of this note will comply with the following standards.

Requirement for Compliance with EMC directive

The following products have shown compliance through direct testing (of the identified standards below) and design analysis (through the creation of a technical construction file) to the European Directive for Electromagnetic Compatibility (2004/108/EC) when used as directed by the appropriate documentation.

Attention

- This product is designed for use in industrial applications. Authorized Representative in the European Community: Mitsubishi Electric Europe B.V.

Type: Programmable Controller (Open Type Equipment) Models: MELSEC FX3U series manufactured from March 1st, 2008 FX3U-64CCL

Table with columns: Standard, Remark. Lists EN61131-2:2007 and compliance with all relevant aspects of the standard.

Caution for EC Directive

Installation in Enclosure

Programmable logic controllers are open-type devices that must be installed and used within conductive control cabinets. Please use the programmable logic controller while installed within a conductive shielded control cabinet.

Control cabinet

- The control cabinet must be conductive. Ground the control cabinet with the thickest possible grounding cable. To ensure that there is electric contact between the control cabinet and its door, connect the cabinet and its doors with thick wires.

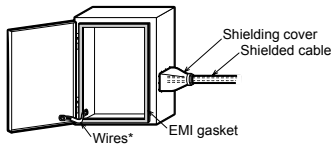

* These wires are used to improve the conductivity between the door and control cabinet.

Configuration example inside control cabinet

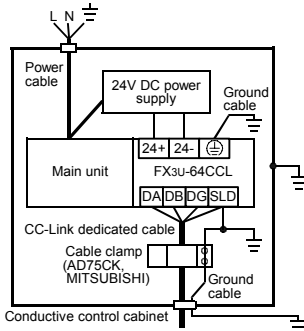

Wiring simplified diagram

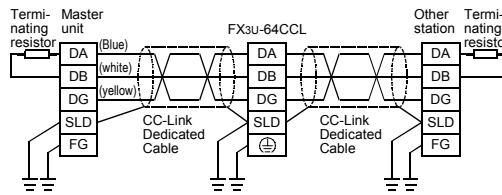

- Notes for compliance with EN61131-2:2007. General notes on the use of the power supply cable. The FX3U-64CCL unit requires that the cable used for power supply is 30m or less.

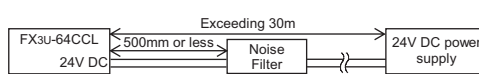

1. Introduction

The CC-Link interface block FX3U-64CCL (hereinafter called 64CCL) is a special function block to connect the FX3G/FX3U/FX3UC Series programmable logic controller to a CC-Link network.

1.1 Major Features of the FX3U-64CCL

- Compatible with CC-Link Ver. 2.00 and Ver. 1.10. The 64CCL is compatible with CC-Link Ver. 2.00, and enables expanded cyclic transmission to facilitate the handling of applications requiring multiple data processing.

1.2 Incorporated Items

Check to ensure the following product and items are included in the package:

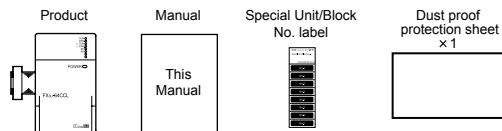

1.3 External Dimensions and Part Names

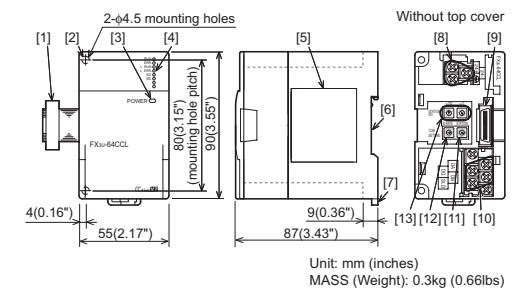

- Extension cable. Direct mounting hole: 2 holes of φ 4.5 (0.18") (mounting screw: M4 screw). POWER LED (green). Status LEDs. Name plate. DIN rail mounting groove (DIN rail: DIN46277, 35mm (1.38") width). DIN rail mounting hook. Power supply terminal block. Extension connector. CC-Link connection terminal block. Transmission rate setting switch. Station number setting switch.

1.4 Power and status LEDs

Table with columns: LED display, Color, Status, Description. Lists POWER, RUN, ERR, L RUN, L ERR, SD, RD LEDs and their states.

1.5 Terminal layout

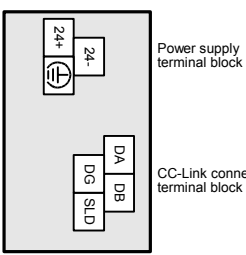

- Terminal screw and terminal block mounting screw size, and tightening torque. Power supply terminal block, CC-Link connection terminal block.

CC-Link connection terminal block can be detached or attached. Make sure to cut off all phases of the power supply externally.

For details on the wiring and the types of connection cables needed to connect to the terminal blocks shown in the figure above, refer to the following manual.

1.6 Switch setting

With regard to the switch setting for station number, transmission rate, hardware test, number of occupied stations and expanded cyclic transmission, the switch settings become valid after 64CCL startup.

For details on the switch setting, refer to the following manual.

1.6.1 Station number setting

Table for station number setting: Setting items, Range, Description.

1.6.2 Transmission rate setting, hardware test

Table for transmission rate setting: Setting, Description, Status.

1.6.3 Number of occupied stations, expanded cyclic setting

Table for number of occupied stations and expanded cyclic setting: Setting, Number of occupied stations, Expanded cyclic setting.

2. Installation

INSTALLATION PRECAUTIONS WARNING box with text: Make sure to cut off all phases of the power supply externally before attempting installation work.

INSTALLATION PRECAUTIONS CAUTION box with text: Use the product within the generic environment specifications described in PLC main unit manual (Hardware Edition).

For details on anchoring, refer to the following manual. Refer to the FX3U-64CCL User's Manual.

2.1 Connection with PLC

Only one 64CCL can be connected to the right side of a PLC main unit or extension unit/block (including special function units/blocks).

For further information on installation arrangements, refer to the following manuals. Refer to the FX3G Series User's Manual - Hardware Edition.

2.2 Mounting

The product is mounted by the following method.

- DIN rail mounting. Direct mounting (mounting screw: M4 screw)

For further information on installation arrangements, refer to the following manuals. Refer to the FX3G Series User's Manual - Hardware Edition.

2.2.1 DIN Rail Mounting

The product can be mounted on a DIN rail (DIN46277, 35mm (1.38") width).

- Fit the upper edge of the DIN rail mounting groove (fig. A) onto the DIN rail. Press the product against the DIN rail. An interval space of 1 to 2 mm (0.04" to 0.08") between each unit is necessary.

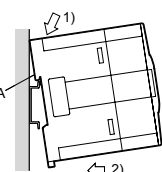

2.2.2 Direct Mounting (mounting screw: M4 screw)

The product can be installed directly with screws. Refer to the External Dimensions (section 1.3) for the product's mounting hole pitch information.

An interval space between each unit of 1 to 2 mm (0.04" to 0.08") is necessary.

3. Specification

For details on specifications, refer to the following manual.

Refer to the FX3U-64CCL User's Manual.

DESIGN PRECAUTIONS WARNING

- For the status of each station when the main unit stops calculation or when a communication error occurs in the data link, thoroughly read the description of data link processing time in the CC-Link master module manual.

- 1) Setting to hold or clear the input information against data link error. Remote outputs (RY) and remote registers (RWw) are held or cleared in accordance with the setting of BFM #32. 2) Setting to hold or clear the data against a stop in the main unit. Remote inputs (RX) and remote registers (RWr) are held or cleared in accordance with the setting of BFM #33.

Especially in control from external equipment to a PLC in a remote place, problems in the PLC may not be able to be handled promptly due to abnormality in data transfer. Construct an interlock circuit in the sequence program. At the same time, determine the actions in the system between the external equipment and the PLC (Master station contains) for protection against abnormalities in data transfer.

DESIGN PRECAUTIONS CAUTION

- Observe the following items. Failure to do so may cause incorrect data-writing through noise to the PLC and result in PLC failure, machine damage or other accident. 1) Do not bundle the control line together with or lay it close to the main circuit or power line. 2) Ground the shield wire or shield of a shielded cable.

DISPOSAL PRECAUTIONS CAUTION

- Please contact a certified electronic waste disposal company for the environmentally safe recycling and disposal of your device.

TRANSPORT AND STORAGE PRECAUTIONS CAUTION

- The PLC is a precision instrument. During transportation, avoid impacts larger than those specified in the general specifications of the PLC main unit manual.

3.1 Applicable PLC

Table with columns: Model name, Applicability. Lists FX3G Series PLC, FX3U Series PLC, and FX3UC Series PLC.

The version number can be checked by monitoring the last three digits of D8001.

*1 An FX2NC-CNV-IF or FX3UC-1PS-5V is necessary to connect the 64CCL with the FX3UC PLC.

3.2 General Specifications

Items other than the following are equivalent to those of the PLC main unit. For general specifications, refer to the manual of the PLC main unit.

Table with columns: Item, Specification. Lists Dielectric withstand voltage, Insulation resistance.

3.3 Power Supply Specification

Table with columns: Item, Specification. Lists Power supply voltage, External power supply.

3.4 Performance Specification

Table with columns: Item, Specification. Lists CC-Link applicable version, Station type, Station number, Transmission rate, etc.

*1 When the setting of the 64CCL is the single setting, please set up the master station as a Ver.1 intelligent device station.

This manual confers no industrial property rights or any rights of any other kind, nor does it confer any patent licenses.

Warranty Mitsubishi will not be held liable for damage caused by factors found not to be the cause of Mitsubishi; opportunity loss or lost profits caused by faults in the Mitsubishi products; damage, secondary damage, accident compensation caused by special factors unpredictable by Mitsubishi; damages to products other than Mitsubishi products; and to other duties.

For safe use

- This product has been manufactured as a general-purpose part for general industries, and has not been designed or manufactured to be incorporated in a device or system used in purposes related to human life.