

PROGRAMMABLE CONTROLLERS
MELSEC-F

FX3U-20SSC-H



USER'S MANUAL



***FX*3U**

Safety Precautions

(Read these precautions before use.)

Before installation, operation, maintenance or inspection of this product, thoroughly read through and understand this manual and all of the associated manuals. Also, take care to handle the module properly and safely.

This manual classifies the safety precautions into two categories:  **WARNING** and  **CAUTION**.

 WARNING	Indicates that incorrect handling may cause hazardous conditions, resulting in death or severe injury.
 CAUTION	Indicates that incorrect handling may cause hazardous conditions, resulting in medium or slight personal injury or physical damage.

Depending on the circumstances, procedures indicated by  **CAUTION** may also cause severe injury. It is important to follow all precautions for personal safety.

Store this manual in a safe place so that it can be taken out and read whenever necessary. Always forward it to the end user.

1. DESIGN PRECAUTIONS

 WARNING	Reference
<ul style="list-style-type: none"> • Make sure to have the following safety circuits outside of the PLC to ensure safe system operation even during external power supply problems or PLC failure. Otherwise, malfunctions may cause serious accidents. <ol style="list-style-type: none"> 1) Most importantly, have the following: an emergency stop circuit, a protection circuit, an interlock circuit for opposite movements (such as normal vs. reverse rotation), and an interlock circuit (to prevent damage to the equipment at the upper and lower positioning limits). 2) Note that when the PLC CPU detects an error, such as a watchdog timer error, during self-diagnosis, all outputs are turned off. Also, when an error that cannot be detected by the PLC CPU occurs in an input/output control block, output control may be disabled. External circuits and mechanisms should be designed to ensure safe machinery operation in such a case. 3) Note that when an error occurs in a relay, triac or transistor output device, the output could be held either on or off. For output signals that may lead to serious accidents, external circuits and mechanisms should be designed to ensure safe machinery operation in such a case. • At Forward/Reverse rotation limits, make sure to wire the contacts with NC, negative-logic. Wiring contacts with NO, positive-logic may cause serious accidents. 	22 42

 CAUTION	Reference
<ul style="list-style-type: none"> • Make sure to observe the following precautions in order to prevent any damage to the machinery or accidents due to abnormal data written to the PLC under the influence of noise: <ol style="list-style-type: none"> 1) Do not bundle the main circuit line together with or lay it close to the main circuit, high-voltage line or load line. Otherwise, noise disturbance and/or surge induction are likely to take place. As a guideline, lay the control line at least 100mm (3.94") or more away from the main circuit or high-voltage lines. 2) Ground the shield wire or shield of the shielded cable at one point on the PLC. However, do not ground them at the same point as the high-voltage lines. • Install module so that excessive force will not be applied to the built-in programming port, input connectors, power connectors or optical connectors. Failure to do so may result in wire damage/breakage or PLC failure. 	22 28 35 42

2. INSTALLATION PRECAUTIONS

 WARNING	Reference
<ul style="list-style-type: none"> • Make sure to cut off all phases of the power supply externally before attempting installation or wiring work. Failure to do so may cause electric shock or damage to the product. 	26

Safety Precautions

(Read these precautions before use.)

 CAUTION	Reference
<ul style="list-style-type: none"> • Connect the extension cables, peripheral device cables and input cables securely to their designated connectors. Loose connections may cause malfunctions. • Use the product within the generic environment specifications described in section 3.1 of this manual. Never use the product in areas with excessive dust, oily smoke, conductive dusts, corrosive gas (salt air, Cl₂, H₂S, SO₂ or NO₂), flammable gas, vibration or impacts, or expose it to high temperature, condensation, or rain and wind. If the product is used in such conditions, electric shock, fire, malfunctions, deterioration or damage may occur. • Do not touch the conductive parts of the product directly. Doing so may cause device failures or malfunctions. • Install the product securely using a DIN rail or mounting screws. • Install the product on a flat surface. If the mounting surface is rough, undue force will be applied to the PC board, thereby causing nonconformities. • When drilling screw holes or wiring, make sure that cutting and wiring debris do not enter the ventilation slits. Failure to do so may cause fire, equipment failures or malfunctions. • Be sure to remove the dust proof sheet from the ventilation slits of product when installation work is completed. Failure to do so may cause fire, equipment failures or malfunctions. • Make sure to attach the top cover, before turning on the power or initiating operation after installation or wiring work. Failure to do so may cause electric shock. 	26

3. WIRING PRECAUTIONS

 WARNING	Reference
<ul style="list-style-type: none"> • Make sure to cut off all phases of the power supply externally before attempting installation or wiring work. Failure to do so may cause electric shock or damage to the product. 	28

 CAUTION	Reference
<ul style="list-style-type: none"> • Connect the DC power supply wiring to the dedicated terminals described in this manual. If an AC power supply is connected to a DC input terminal or DC power supply terminal, the product will burn out. • Perform class D grounding (grounding resistance: 100Ω or less) to the grounding terminal on the 20SSC-H with a wire as thick as possible. Do not use common grounding with heavy electrical systems (refer to subsection 5.2.2). • Make sure to attach the top cover, before turning on the power or initiating operation after installation or wiring work. Failure to do so may cause electric shock. • Connect the inputs of the 20SSC-H to the dedicated connectors described in this manual. If an AC power supply is connected to a DC input terminal or DC power supply terminal, the product will burn out. • Do not wire vacant terminals externally. Doing so may damage the product. • When drilling screw holes or wiring, make sure cutting or wire debris do not enter the ventilation slits. Failure to do so may cause fire, equipment failures or malfunctions. • Make sure to properly wire to the FX Series terminal blocks in accordance with the following precautions. Failure to do so may cause electric shock, equipment failures, a short-circuit, wire breakage, malfunctions, or damage to the product. <ul style="list-style-type: none"> - The disposal size of the cable end should follow the dimensions described in the manual of the PLC main unit. - Tightening torque should follow the specifications in the manual of the PLC main unit. • Do not wire or bundle the SSCNET III cables together with or lay them near a main circuit cable, high-voltage line, or load lines separate from the PLC. As a guideline, lay the SSCNET III cables at least 100mm (3.94") or more away from power lines. Failure to do so may cause surge induction and/or noise disturbance. • Optical fiber end face defects that are caused from contaminants may deteriorate the signal transmission rate and cause malfunction. When removing the SSCNET III cabling from the 20SSC-H port, make sure to attach the protective caps to the cable connectors and ports. • Do not remove the SSCNET III cable from its port while the power is ON for the 20SSC-H or Servo Amp. Do not look directly into the optical fiber cable ends or SSCNET III ports, as doing so may cause eye damage. (The laser for SSCNET III communication complies with Class 1 as defined in JISC6802 and IEC60825-1) • When handling the SSCNET III cables, do not expose them to strong impact, lateral pressure, excessive pulling tension, abrupt bending or twisting. Failure to do so may crack the glass fiber and cause signal transmission loss. Note that a short SSCNET III cable is highly susceptible to twisting. • Make sure to use the SSCNET III cable within the allowable temperature range (as shown in subsection 5.1.1). Do not expose the SSCNET III cabling to fire or excessive heat. Avoid contact with high temperature components such as the servo amplifier radiator, regenerative brake and servo motor. • Do not force the SSCNET III cable into a bend radius smaller than the minimum allowable bend radius. (Refer to subsection 5.4.1 Precautions for the SSCNET III cable wiring.) 	28

Safety Precautions

(Read these precautions before use.)

 CAUTION	Reference
<ul style="list-style-type: none"> Put the SSCNET III cable in the duct or fix the cable at the closest part to the 20SSC-H with bundle material in order to prevent SSCNET III cable from putting its own weight on SSCNET III connector. When laying cable, the optical cord should be given loose slack to avoid from becoming smaller than the minimum bend radius, and it should not be twisted. Also, fix and hold it in position with using cushioning such as sponge or rubber which does not contain plasticizing material. When using adhesive tape to bundle, use flame-resistant acetate cloth adhesive tape (e.g. 570F by Teraoka Seisakusho Co., Ltd.). Migrating plasticizer is used for vinyl tape. Keep the MR-J3BUS□M, and MR-J3BUS□M-A cables away from vinyl tape because the optical characteristic may be affected. Generally, soft polyvinyl chloride (PVC), polyethylene resin (PE) and fluorine resin contain non-migrating plasticizer and they do not affect the optical characteristic of SSCNET III cable. However, some wire sheaths and cable ties, which contain migrating plasticizer (phthalate ester), may affect MR-J3BUS□M and MR-J3BUS□M-A cables. In addition, MR-J3BUS□M-B cable is not affected by plasticizer. Exposing the SSCNET III cable to solvent/oil may deteriorate the optical fiber and alter its mechanical characteristics. When using the SSCNET III cable near solvent/oil, take protective measures to shield the SSCNET III cable. When storing the SSCNET III cable, attach the protective cap to the 20SSC-H connector port for dust protection Do not remove the protective cap from the 20SSC-H connector port until just before connecting the SSCNET III cable. Attach the protective cap to the 20SSC-H connector port after removing the SSCNET III cable to protect the internal optical device from exposure to dust. Keep the protective cap and protective tubing clean, and always store them in the provided plastic bag when removing them from the hardware devices. When replacing the 20SSC-H, or when sending the product to your local Mitsubishi Electric representative for repair, make sure to attach the protective cap to the 20SSC-H connector port. Failure to do so may damage the internal optical device and require optical device replacement. 	28 29

4. STARTUP AND MAINTENANCE PRECAUTIONS

 WARNING	Reference
<ul style="list-style-type: none"> Do not touch any terminal while the PLC's power is on. Doing so may cause electric shock or malfunctions. Before cleaning or retightening terminals, cut off all phases of the power supply externally. Failure to do so may cause electric shock. Before modifying or disrupting the program in operation or running the PLC, carefully read through this manual and the associated manuals and ensure the safety of the operation. An operation error may damage the machinery or cause accidents. Before operating the Zero-return/JOG or testing of the positioning data, carefully read through this manual and the associated manuals and ensure the safety of the operation. An operation error may damage the machinery or cause accidents. 	35 253 271

 CAUTION	Reference
<ul style="list-style-type: none"> Do not disassemble or modify the PLC. Doing so may cause fire, equipment failures, or malfunctions. For repair, contact your local Mitsubishi Electric representative. Turn off the power to the PLC before connecting or disconnecting any extension cable. Failure to do so may cause equipment failures or malfunctions. Turn off the power to the PLC before attaching or detaching the following devices. Failure to do so may cause equipment failures or malfunctions. <ul style="list-style-type: none"> Peripheral devices, expansion boards, and special adapters Extension units/blocks and FX Series terminal blocks. 	35 253 271

5. DISPOSAL PRECAUTIONS

 CAUTION	Reference
<ul style="list-style-type: none"> Please contact a certified electronic waste disposal company for the environmentally safe recycling and disposal of your device. 	22

Safety Precautions

(Read these precautions before use.)

6. TRANSPORTATION AND STORAGE PRECAUTIONS

 CAUTION	Reference
<ul style="list-style-type: none">The PLC is a precision instrument. During transportation, avoid impacts larger than those specified in the general specifications of the PLC main unit manual by using dedicated packaging boxes and shock-absorbing palettes. Failure to do so may cause failures in the PLC. After transportation, verify operation of the PLC and check for damage of the mounting part, etc.	22

FX3U-20SSC-H

User's Manual

Manual number	JY997D21301
Manual revision	M
Date	4/2015

Foreword

This manual describes the FX3U-20SSC-H Positioning Block and should be read and understood before attempting to install or operate the hardware.

Store this manual in a safe place so that you can take it out and read it whenever necessary. Always forward it to the end user.

This manual confers no industrial property rights or any rights of any other kind, nor does it confer any patent licenses. Mitsubishi Electric Corporation cannot be held responsible for any problems involving industrial property rights which may occur as a result of using the contents noted in this manual.

Outline Precautions

- This manual provides information for the use of the FX3U-20SSC-H Positioning Block. The manual has been written to be used by trained and competent personnel. The definition of such a person or persons is as follows;
 - 1) Any engineer who is responsible for the planning, design and construction of automatic equipment using the product associated with this manual should be of a competent nature, trained and qualified to the local and national standards required to fulfill that role. These engineers should be fully aware of all aspects of safety with aspects regarding to automated equipment.
 - 2) Any commissioning or maintenance engineer must be of a competent nature, trained and qualified to the local and national standards required to fulfill the job. These engineers should also be trained in the use and maintenance of the completed product. This includes being familiar with all associated manuals and documentation for the product. All maintenance should be carried out in accordance with established safety practices.
 - 3) All operators of the completed equipment should be trained to use that product in a safe and coordinated manner in compliance with established safety practices. The operators should also be familiar with documentation that is connected with the actual operation of the completed equipment.

Note: The term 'completed equipment' refers to a third party constructed device that contains or uses the product associated with this manual.

- This product has been manufactured as a general-purpose part for general industries, and has not been designed or manufactured to be incorporated in a device or system used in purposes related to human life.
- Before using the product for special purposes such as nuclear power, electric power, aerospace, medicine or passenger movement vehicles, consult with Mitsubishi Electric.
- This product has been manufactured under strict quality control. However when installing the product where major accidents or losses could occur if the product fails, install appropriate backup or failsafe functions into the system.
- When combining this product with other products, please confirm the standards and codes of regulation to which the user should follow. Moreover, please confirm the compatibility of this product with the system, machines, and apparatuses to be used.
- If there is doubt at any stage during installation of the product, always consult a professional electrical engineer who is qualified and trained in the local and national standards. If there is doubt about the operation or use, please consult your local Mitsubishi Electric representative.
- Since the examples within this manual, technical bulletin, catalog, etc. are used as reference; please use it after confirming the function and safety of the equipment and system. Mitsubishi Electric will not accept responsibility for actual use of the product based on these illustrative examples.
- The content, specification etc. of this manual may be changed for improvement without notice.
- The information in this manual has been carefully checked and is believed to be accurate; however, if you notice any doubtful point, error, etc., please contact your local Mitsubishi Electric representative.

Registration

- Microsoft® and Windows® are either registered trademarks or trademarks of Microsoft Corporation in the United States and/or other countries.
- The company name and the product name to be described in this manual are the registered trademarks or trademarks of each company.

Table of Contents

SAFETY PRECAUTIONS	(1)
Standards	9
Certification of UL, cUL standards	9
Compliance with EC directive (CE Marking)	9
Functions and Use of the Manual	11
Associated Manuals	12
Generic Names and Abbreviations Used in the Manual	14
Reading the Manual	16

1. Introduction **17**

1.1 Outline.....	17
1.2 External Dimensions and Part Names	18
1.3 Power and Status LED.....	19

2. System Configuration **20**

2.1 General Configuration.....	20
2.2 Connection with PLC.....	21
2.3 Applicable PLC.....	21

3. Specifications **22**

3.1 General Specifications	22
3.2 Power Supply Specification.....	23
3.3 Performance Specification	23
3.4 Input Specifications	24
3.4.1 Input specifications	24
3.4.2 Internal input circuit	24
3.5 Pin Configuration.....	25
3.5.1 Input connector.....	25
3.5.2 Power supply connector	25

4. Installation **26**

4.1 DIN rail Mounting	27
4.2 Direct Mounting.....	27

5. Wiring **28**

5.1 Cable to Be Used, Applicable Connector and Wire Size	29
5.1.1 SSCNET III cable	29
5.1.2 Power supply cable	29
5.1.3 Input cable and terminal block.....	30
5.2 Power Supply Wiring.....	31
5.2.1 Power supply wiring.....	31
5.2.2 Grounding.....	31
5.3 Input Wiring.....	32
5.3.1 Sink input wiring	32
5.3.2 Source input wiring	32
5.4 Connecting the SSCNET III Cabling	33
5.4.1 Cautions for installing the SSCNET III cabling	33
5.4.2 Cautions for SSCNET III cable wiring.....	34

6. Memory Configuration and Data Operation	35
6.1 Memory Configuration and Role	36
6.1.1 Memory configuration	36
6.1.2 Data type and role	37
6.2 Data Transfer Process	38
6.2.1 Data transfer processing among the PLC, 20SSC-H and servo amplifier	38
6.2.2 Data transfer processing between FX Configurator-FP and 20SSC-H	39
6.2.3 Transfer (writing) servo parameters to servo amplifier	40
7. Before Starting Positioning Operation	42
7.1 Note on Setting Parameters	43
7.1.1 Types of parameter setting method	45
7.1.2 Setting parameters [FX Configurator-FP] [Recommended]	46
7.1.3 Initializing parameters [FX Configurator-FP]	49
7.1.4 Setting parameters from flash memory [Sequence program]	51
7.1.5 Setting parameters from the buffer memory [sequence program] (Ver. 1.10 or later)	59
7.1.6 Initializing parameters [sequence program]	68
7.1.7 Updating positioning parameters [sequence program]	71
7.1.8 Updating some servo parameters [sequence program]	74
7.1.9 Saving parameters and table information to flash memory [sequence program]	77
7.2 Outline of Positioning Operation	80
7.3 Handling the Forward Rotation Limit and Reverse Rotation Limit	83
7.3.1 Forward rotation limit 2 (FLS) and reverse rotation limit 2 (RLS) [Servo amplifier limit]	84
7.3.2 Forward rotation limit 1 (LSF) and reverse rotation limit 1 (LSR) [PLC side limit]	84
7.3.3 Software limit	85
7.4 Handling the STOP command	86
7.5 Sudden stop selection (Ver.1.20 or later)	89
7.6 Changing During Operation (Operation Speed, Target Address)	93
7.6.1 Changing the operation speed with the override function	93
7.6.2 Changing the operation speed with the operation speed change function	95
7.6.3 Changing target address during operation using target address change function	99
7.7 Acceleration/deceleration time selection (Ver. 1.30 or later)	105
7.8 Ring counter setting (Ver.1.10 or later)	108
7.9 Other functions	112
7.9.1 Servo-ready check function	112
7.9.2 Servo end check function	113
7.9.3 Torque limit function	114
7.9.4 Absolute position detection system	116
7.9.5 Servo ON/OFF	117
7.9.6 Servo ON/OFF status selection at startup (Ver. 1.30 or later)	118
7.9.7 Follow-up function	119
7.9.8 Simultaneous start function	119
7.9.9 Current address change function	120
7.9.10 Zero return interlock function	120
7.9.11 Positioning completion signal output waiting time (Ver.1.20 or later)	121
7.9.12 System reset command (Ver.1.10 or later)	123
7.9.13 Servo parameter update stop (Ver.1.10 or later)	123
7.10 Precautions for using the user units (mechanical or composite system of units)	124
7.11 Cautions for Positioning Operation	126
7.11.1 Overlapped specification of operation mode	126
7.11.2 When the travel distance is small	126
7.11.3 Setting of interpolation operation, pulse rate and feed rate	133
7.11.4 Cautions on continuous pass operation	134
7.11.5 Cautions when acceleration/deceleration time is changed during positioning operation	135

8. Manual Control	136
8.1 Mechanical Zero Return Control	136
8.1.1 Outline of mechanical zero return control	136
8.1.2 DOG type mechanical zero return	137
8.1.3 Data-set type mechanical zero return	140
8.1.4 Stopper type (1) mechanical zero return operation	141
8.1.5 Stopper type (2) Mechanical zero return operation	143
8.2 JOG Operation	145
8.2.1 Outline of JOG operation	145
8.2.2 Changing the speed during JOG operation	146
8.3 Manual pulse generator operation	148
8.3.1 Outline of manual pulse generator operation	148
8.3.2 Current manual pulse input value	152
8.3.3 Input frequency of manual pulse generator	152
9. Positioning Control	153
9.1 Functions Available with Each Positioning Operation	153
9.2 1-speed Positioning Operation	154
9.3 Interrupt 1-speed Constant Quantity Feed	156
9.3.1 Interrupt 1-speed Constant Quantity Feed	156
9.3.2 Interrupt 1-speed Constant Quantity Feed (Constant position stop mode)	159
9.4 2-speed Positioning Operation	162
9.5 Interrupt 2-speed Constant Quantity Feed	165
9.6 Interrupt Stop Operation	168
9.7 Variable Speed Operation	171
9.8 Multi-Speed Operation	173
9.9 Linear Interpolation Operation	176
9.10 Linear Interpolation Operation (Interrupt Stop)	179
9.11 Circular Interpolation Operation	182
9.11.1 Circular interpolation [center coordinate specification]	182
9.11.2 Circular interpolation [radius specification]	185
9.12 Reciprocal movement instruction (Ver.1.10 or later)	188
10. Table Operation	192
10.1 Outline of Table Operation	192
10.1.1 Applicable positioning operations for table operation	192
10.1.2 Types of table information and number of registered tables	192
10.1.3 Table information setting items	193
10.1.4 Table operation execution procedure	196
10.2 How to Set Table Information	197
10.3 Tables and BFM No. Allocation	200
10.4 Current Position Change	201
10.5 Absolute Address Specification	201
10.6 Relative address specification	201
10.7 Jump	201
10.8 Dwell	201
10.9 m code	202
10.9.1 after mode	202
10.9.2 with mode	203
10.10 Continuous Pass Operation	204

11. Buffer Memory (Parameters & Monitored Data)	206
11.1 Positioning Parameters	206
11.1.1 Operation parameters 1 [BFM #14000, BFM #14200]	206
11.1.2 Operation parameters 2 [BFM #14002, BFM #14202]	208
11.1.3 Pulse rate [BFM #14005, #14004, BFM #14205, #14204]	209
11.1.4 Feed rate [BFM #14007, #14006, BFM #14207, #14206]	209
11.1.5 Maximum speed [BFM #14009, #14008, BFM #14209, #14208]	210
11.1.6 JOG speed [BFM #14013, #14012, BFM #14213, #14212]	210
11.1.7 JOG Instruction evaluation time [BFM #14014, BFM #14214]	210
11.1.8 Acceleration time [BFM #14018, BFM #14218]	211
11.1.9 Deceleration time [BFM #14020, BFM #14220]	211
11.1.10 Interpolation time constant [BFM #14022, BFM #14222]	211
11.1.11 Zero return speed (High Speed) [BFM #14025, #14024, BFM #14225, #14224]	212
11.1.12 Zero return speed (Creep) [BFM #14027, #14026, BFM #14227, #14226]	212
11.1.13 Mechanical zero-point address [BFM #14029, #14028, BFM #14229, #14228]	212
11.1.14 Zero-phase signal count [BFM #14030, BFM #14230]	213
11.1.15 Zero return mode [BFM #14031, BFM #14231]	213
11.1.16 Servo end evaluation time [BFM #14032, BFM #14232]	213
11.1.17 Software limit (upper) [BFM #14035, #14034, BFM #14235, #14234] Software limit (lower) [BFM #14037, #14036, BFM #14237, #14236]	214
11.1.18 Torque limit value [BFM #14038, BFM #14238]	214
11.1.19 Zero return torque limit [BFM #14040, BFM #14240]	214
11.1.20 External input selection [BFM #14044, BFM #14244]	215
11.1.21 Ring counter upper limit value [BFM #14101, #14100, BFM #14301, #14300]	215
11.1.22 Sudden stop deceleration time [BFM #14102, BFM #14302]	215
11.1.23 Sudden stop interpolation time constant [BFM #14104, BFM #14304]	216
11.1.24 Positioning completion signal output waiting time [BFM #14106, BFM #14306]	216
11.1.25 Acceleration time 2 [BFM #14108, BFM #14308]	216
11.1.26 Deceleration time 2 [BFM #14110, BFM #14310]	217
11.2 Servo Parameters	218
11.2.1 Servo parameters (Basic settings)	218
11.2.2 Servo parameters (Gain/Filter settings)	222
11.2.3 Servo parameters (Advanced setting)	225
11.2.4 Servo parameters (I/O setting)	227
11.3 Monitor Data	229
11.3.1 Current address (User) [BFM #1, #0, BFM #101, #100]	229
11.3.2 Current address (Pulse) [BFM #3, #2, BFM #103, #102]	229
11.3.3 Torque limit storing value [BFM #5, #4, BFM #105, #104]	230
11.3.4 Error BFM numbers [BFM #6, BFM #106]	230
11.3.5 Terminal Information [BFM #7, BFM #107]	230
11.3.6 Servo terminal information [BFM #8, BFM #108]	230
11.3.7 m code [BFM #9, BFM #109]	231
11.3.8 Current value of operation speed [BFM #11, #10, BFM #111, #110]	231
11.3.9 Current pulses input by manual pulse generator [BFM #13, #12, BFM #113, #112]	231
11.3.10 Frequency of pulses input by manual pulse generator [BFM #15, #14, BFM #115, #114]	231
11.3.11 Table numbers in execution [BFM #16, BFM #116]	231
11.3.12 Version information [BFM #17]	232
11.3.13 Real current address (User) [BFM #21, #20, BFM #121, #120]	232
11.3.14 Real current address (Pulse) [BFM #23, #22, BFM #123, #122]	232
11.3.15 Received target address [BFM #25, #24, BFM #125, #124]	232
11.3.16 Received target speed [BFM #27, #26, BFM #127, #126]	233
11.3.17 Status information [BFM #28, BFM #128]	233
11.3.18 Error code [BFM #29, BFM #129]	235
11.3.19 Model code [BFM #30]	235
11.3.20 Status information 2 [BFM #32, BFM #132]	235
11.3.21 Current address when an interrupt occurs (INT0) [BFM #35, #34, BFM #135, #134], Current address when an interrupt occurs (INT1) [BFM #37, #36, BFM #137, #136]	236
11.3.22 Deviation counter value [BFM #51, #50, BFM #151, #150]	236
11.3.23 Motor speed [BFM #53, #52, BFM #153, #152]	236
11.3.24 Motor current value [BFM #54, BFM #154]	236
11.3.25 Servo amplifier software number [BFM #61 to #56, BFM #161 to #156]	237
11.3.26 Servo parameter error numbers [BFM #62, BFM #162]	237

11.3.27	Servo status [BFM #64, #63, BFM #164, #163]	238
11.3.28	Regenerative load ratio [BFM #65, BFM #165]	238
11.3.29	Effective load torque [BFM #66, BFM #166]	238
11.3.30	Peak torque ratio [BFM #67, BFM #167]	238
11.3.31	Servo warning code [BFM #68, BFM #168]	239
11.3.32	Motor feedback position [BFM #71, #70, BFM #171, #170]	239
11.3.33	Servo status 2 [BFM #72, BFM #172]	239
11.3.34	Flash memory write count [BFM #91, #90]	239
11.4	Control Data	240
11.4.1	Target address 1 [BFM #501, #500, BFM #601, #600]	240
11.4.2	Operation speed 1 [BFM #503, #502, BFM #603, #602]	240
11.4.3	Target address 2 [BFM #505, #504, BFM #605, #604]	241
11.4.4	Operation speed 2 [BFM #507, #506, BFM #607, #606]	241
11.4.5	Override setting [BFM #508, BFM #608]	241
11.4.6	Torque output setting value [BFM #510, BFM #610]	241
11.4.7	Speed change value [BFM #513, #512, BFM #613, #612]	242
11.4.8	Target position change value (Address) [BFM #515, #514, BFM #615, #614]	242
11.4.9	Target position change value (Speed) [BFM #517, #516, BFM #617, #616]	242
11.4.10	Operation command 1 [BFM #518, BFM #618]	242
11.4.11	Operation command 2 [BFM #519, BFM #619]	244
11.4.12	Operation pattern selection [BFM #520, BFM #620]	245
11.4.13	Table operation start number [BFM #521, BFM #621]	247
11.4.14	Control command enable/disable [BFM #522]	247
11.4.15	Control command [BFM #523]	247
11.4.16	Manual pulse generator input magnification (numerator) [BFM #525, #524, BFM #625, #624]	248
11.4.17	Manual pulse generator input magnification (denominator) [BFM #527, #526, BFM #627, #626]	248
11.4.18	Manual pulse generator response [BFM #528, BFM #628]	249
11.4.19	Manual pulse generator input selection [BFM #529]	249
11.4.20	Ring operation rotation direction for absolute address	249
11.5	Table Information	250

12. Program Example

253

12.1	Reading/Writing Buffer Memory	254
12.1.1	Assigned unit number	254
12.1.2	How to read/write from/to buffer memory	254
12.2	Device Assignments	259
12.3	Explanation of Operation	260
12.3.1	Mechanical zero return	261
12.3.2	JOG operation	261
12.3.3	1-speed positioning operation	262
12.3.4	Multi-speed operation [table operation (individual)]	262
12.3.5	Circular interpolation operation [table operation (simultaneous)]	264
12.4	Sequence Program	264

13. Diagnostics

271

13.1	Check LEDs	272
13.1.1	Check LEDs	272
13.1.2	Input LED state indications	272
13.2	Check Error Code	273
13.2.1	Checking errors	273
13.2.2	How to reset an error	273
13.2.3	Error code list [BFM #29 (X-axis), BFM #129 (Y-axis)]	274
13.2.4	Servo warning list [BFM #68 (X-axis), BFM #168 (Y-axis)]	279
13.3	Diagnostics on the PLC Main Unit	281
13.3.1	POWER LED [on/flashing/off]	281
13.3.2	BATT LED [on/off]	281
13.3.3	ERROR LED [on/flashing/off]	282

Appendix A: LIST OF PARAMETERS AND DATA	283
--	------------

Appendix A-1 Monitor Data List	283
Appendix A-2 Control Data Table	285
Appendix A-3 Table Information List.....	287
Appendix A-4 Positioning parameters List.....	289
Appendix A-5 Servo Parameters List.....	291

Appendix B: Version Information	294
--	------------

Appendix B-1 Version Information	294
Appendix B-1-1 Version check method	294
Appendix B-1-2 Version Upgrade History.....	294

Warranty	296
Revised History	297

Standards

Certification of UL, cUL standards

The following product has UL and cUL certification.

UL, cUL File number :E95239

Models: MELSEC FX3U series manufactured

from June 1st, 2006

FX3U-20SSC-H

Compliance with EC directive (CE Marking)

This document does not guarantee that a mechanical system including this product will comply with the following standards.

Compliance to EMC directive and LVD directive for the entire mechanical module should be checked by the user / manufacturer. For more details please contact the local Mitsubishi Electric sales site.

Requirement for Compliance with EMC directive

The following products have shown compliance through direct testing (of the identified standards below) and design analysis (through the creation of a technical construction file) to the European Directive for Electromagnetic Compatibility (2004/108/EC) when used as directed by the appropriate documentation.

Attention

- This product is designed for use in industrial applications.

Note

- Authorized Representative in the European Community:
Mitsubishi Electric Europe B.V.
Gothaer Str. 8, 40880 Ratingen, Germany

Type: Programmable Controller (Open Type Equipment)

Models: MELSEC FX3U series manufactured

from December 1st, 2005 FX3U-20SSC-H

Standard	Remark
EN61131-2:2007 Programmable controllers - Equipment requirements and tests	Compliance with all relevant aspects of the standard. EMI • Radiated Emission • Conducted Emission EMS • Radiated electromagnetic field • Fast transient burst • Electrostatic discharge • High-energy surge • Voltage drops and interruptions • Conducted RF • Power frequency magnetic field

Caution to conform with EC Directives

Attach the ferrite cores to the power supply and the input cables (20SSC-H side).

Attach the ferrite core approximately 200 mm or less from connector on the 20SSC-H side.

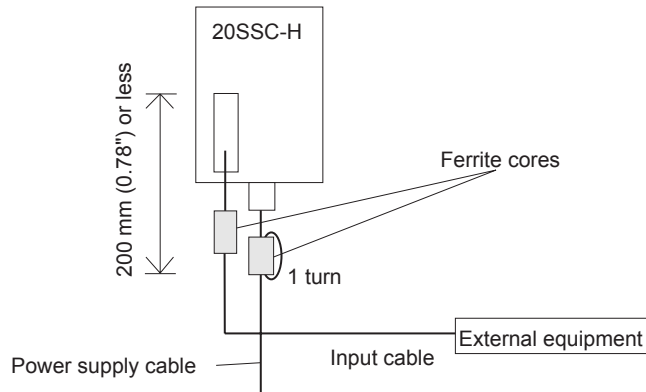

- The ferrite core should use the following equivalent product:

- Power supply cable (needs at least 1 turn)
Model name: ZCAT2035-0930
(Manufactured by TDK co., Ltd.)
- Input cable
Model name: ZCAT3035-1330
(Manufactured by TDK co., Ltd.)

Functions and Use of the Manual

PLC

FX3U Series

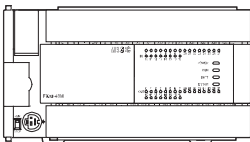

FX3UC Series

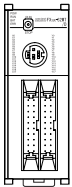

Regarding wiring and installation of PLC:

- Hardware manual Supplied Manual
- User's Manual - Hardware Edition Additional Manual



FX Configurator-FP

FX Configurator-FP



How to install/use the device

- Operation Manual Supplied Manual

FX3U-20SSC-H

FX3U-20SSC-H

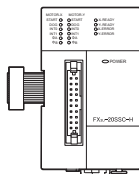

Regarding specification and parts names

- Installation Manual Supplied Manual

This Manual

Operating instructions and program examples

- User's Manual Additional Manual

Shows how to use FX3U-20SSC-H positioning special function block and details on example programs.

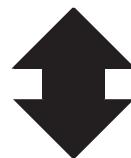

Servo amplifier, Servo motor

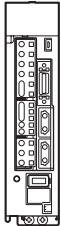

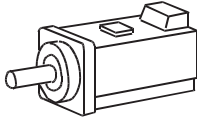

Obtain the instruction manual of the servo motor to be connected to your system.
This manual will be needed to set the parameters for the servo amplifier or write to the servo amplifier.

Associated Manuals

For a detailed explanation of the FX3U-20SSC-H positioning block, refer to this manual.

For the operation of FX Configurator-FP, or hardware information and instructions on the PLC main unit, refer to the respective manuals.

- ⊙ Refer to these manuals
- Refer to the appropriate equipment manual
- △ For a detailed explanation, refer to an additional manual

		Title of manual	Document number	Description	Model code
Manual for the Main Module					
FX3U Series PLCs Main Unit					
△	Supplied Manual	FX3U Series Hardware Manual	JY997D50301	Describes FX3U Series PLC specification for I/O, wiring and installation extracted from the FX3U User's Manual - Hardware Edition. For details, refer to FX3U Series User's Manual - Hardware Edition.	-
⊙	Additional Manual	FX3U Series User's Manual - Hardware Edition	JY997D16501	Describes FX3U Series PLC specification details for I/O, wiring, installation and maintenance.	09R516
FX3UC Series PLCs Main Unit					
△	Supplied Manual	FX3UC (D,DS,DSS) Series Hardware Manual	JY997D50501	Describes FX3UC (D,DS,DSS) PLC Series PLC specification for I/O, wiring and installation extracted from the FX3UC User's Manual - Hardware Edition. For details, refer to FX3UC Series User's Manual - Hardware Edition	-
△	Supplied Manual	FX3UC-32MT-LT Hardware Manual (Only Japanese document)	JY997D12701	Describes FX3UC-32MT-LT PLC Series PLC specification for I/O, wiring and installation extracted from the FX3UC User's Manual - Hardware Edition. For details, refer to FX3UC Series User's Manual - Hardware Edition	-
△	Supplied Manual	FX3UC-32MT-LT-2 Hardware Manual	JY997D31601	Describes FX3UC-32MT-LT-2 PLC Series PLC specification for I/O, wiring and installation extracted from the FX3UC User's Manual - Hardware Edition. For details, refer to FX3UC Series User's Manual - Hardware Edition	-
⊙	Additional Manual	FX3UC Series User's Manual - Hardware Edition	JY997D28701	Describes FX3UC Series PLC specification details for I/O, wiring, installation and maintenance.	09R519
Programming for FX3S/FX3G/FX3GC/FX3U/FX3UC Series					
⊙	Additional Manual	FX3S/FX3G/FX3GC/FX3U/FX3UC Series Programming Manual - Basic & Applied Instruction Edition	JY997D16601	Describes FX3S/FX3G/FX3GC/FX3U/FX3UC Series PLC programming for basic/ applied instructions and devices.	09R517
○	Additional Manual	MELSEC-Q/L/F Structured Programming Manual (Fundamentals)	SH-080782	Programming methods, specifications, functions, etc. required to create structured programs.	13JW06
○	Additional Manual	FXCPU Structured Programming Manual [Device & Common]	JY997D26001	Devices, parameters, etc. provided in structured projects of GX Works2.	09R925
○	Additional Manual	FXCPU Structured Programming Manual [Basic & Applied Instruction]	JY997D34701	Sequence instructions provided in structured projects of GX Works2.	09R926
○	Additional Manual	FXCPU Structured Programming Manual [Application Functions]	JY997D34801	Application functions provided in structured projects of GX Works2.	09R927

		Title of manual	Document number	Description	Model code
Manuals for FX3U-20SSC-H Positioning Block					
△	Supplied Manual	FX3U-20SSC-H Installation Manual	JY997D21101	Describes FX3U-20SSC-H positioning block specification for I/O, power supply extracted from the FX3U-20SSC-H User's Manual. For details, refer to FX3U-20SSC-H User's Manual.	-
⊙	Additional Manual	FX3U-20SSC-H User's Manual	JY997D21301	Describes FX3U-20SSC-H Positioning block details.	09R622
⊙	Supplied Manual	FX Configurator-FP Operation Manual	JY997D21801	Describes operation details of FX Configurator-FP Configuration Software.	09R916
AC Servo Related Manual					
○	Additional Manual	MR-J3-□B Instruction Manual	SH-030051	Explains parameters and the detailed specifications for MR-J3-□B servo amplifier.	-
○	Additional Manual	MR-J3W-□B Instruction Manual	SH-030073	Explains parameters and the detailed specifications for MR-J3W-□B servo amplifier.	-
○	Additional Manual	MR-J3-□B Safety Instruction Manual	SH-030084	Explains parameters and the detailed specifications for MR-J3-□BS servo amplifier.	-
○	Additional Manual	MR-J4-□B Instruction Manual	SH-030106	Explains parameters and the detailed specifications for MR-J4-□B servo amplifier.	-
○	Additional Manual	MR-J4W2-□B Instruction Manual	SH-030105	Explains parameters and the detailed specifications for MR-J4W2-□B servo amplifier.	-
○	Additional Manual	EMC Installation Guidelines	IB67339	Explains installation procedures to conform with EMC Directives and fabrication method of control board.	-

Generic Names and Abbreviations Used in the Manual

Generic name or abbreviation	Description
PLC	
FX3U series	Generic name for FX3U Series PLC
FX3U PLC or main unit	Generic name for FX3U Series PLC main unit
FX3UC series	Generic name for FX3UC Series PLC
FX3UC PLC or main unit	Generic name for FX3UC Series PLC main unit
Expansion board	
Expansion board	Generic name for expansion board The number of connectable units, however, depends on the type of main unit. To check the number of connectable units, refer to the User's Manual - Hardware Edition of the main unit to be used for your system.
Special adapter	
Special adapter	Generic name for high-speed input/output special adapter, communication special adapter, and analog special adapter The number of connectable units, however, depends on the type of main unit. To check the number of connectable units, refer to the User's Manual - Hardware Edition of the main unit to be used for your system.
Special function unit/block	
Special function unit/block or Special extension unit	Generic name for special function unit and special function block The number of connectable units, however, depends on the type of main unit. To check the number of connectable units, refer to the User's Manual - Hardware Edition of the main unit to be used for your system.
Special function unit	Generic name for special function unit
Special function block	Generic name for special function block The number of connectable units, however, depends on the type of main unit. To check the number of connectable units, refer to the User's Manual - Hardware Edition of the main unit to be used for your system.
Positioning special function block or 20SSC-H	Abbreviated name for FX3U-20SSC-H
Optional unit	
FX Series terminal block	FX-16E-TB, FX-32E-TB
Input/output cable or Input cable	FX-16E-500CAB-S, FX-16E- □ □ □CAB, FX-16E- □ □ □CAB-R □ □ □ represents 150, 300, or 500.
Input/output connector	FX2C-I/O-CON, FX2C-I/O-CON-S, FX2C-I/O-CON-SA
Power cable	FX2NC-100MPCB, FX2NC-100BPCB, FX2NC-10BPCB1
Peripheral unit	
Peripheral unit	Generic name for programming software and indicator
Programming tool	
Programming tool	Generic name for programming software
Programming software	Generic name for programming software
GX Works2	Generic name for SW □DNC-GXW2-J/SW □DNC-GXW2-E programming software package
GX Developer	Generic name for SW □D5C-GPPW-J/SW □D5C-GPPW-E programming software package
Configuration software	
Configuration software or FX Configurator-FP	Abbreviated name for FX Configurator-FP Configuration software
Indicator	
GOT1000 series	Generic name for GT15, GT11 and GT10

Generic name or abbreviation	Description
Servo motor/servo amplifier	
Servo motor	Generic name for servo motor or stepping motor Including servo amplifier corresponding to SSCNET III.
Servo amplifier	Generic name for servo amplifier corresponding to SSCNET III
MR-J3-□B series	Generic name for MELSERVO-J3-□B series
MR-J3W-□B series	Generic name for MELSERVO-J3W-□B series
MR-J3-□BS series	Generic name for MELSERVO-J3-□BS series
MR-J4-□B series	Generic name for MELSERVO-J4-□B series
MR-J4W2-□B series	Generic name for MELSERVO-J4W2-□B series
SSCNET III	Abbreviated name for the high-speed synchronous network communication between the 20SSC-H and a servo amplifier
Other unit	
Manual pulse generator	Generic name for manual pulse generator (prepared by user)
Manual	
FX3U hardware Edition	FX3U Series User's Manual - Hardware Edition
FX3UC hardware Edition	FX3UC Series User's Manual - Hardware Edition
Programming manual	FX3S/FX3G/FX3GC/FX3U/FX3UC Series Programming Manual - Basic and Applied Instruction Edition
Communication control Edition	FX Series User's Manual - Data Communication Edition
Analog control Edition	FX3S/FX3G/FX3GC/FX3U/FX3UC Series User's Manual - Analog Control Edition
Positioning control Edition	FX3S/FX3G/FX3GC/FX3U/FX3UC Series User's Manual - Positioning Control Edition

Reading the Manual

Shows the manual title.

This area shows the manual title for the current page.

Shows the title of the chapter and the title of the section.

This area shows the title of the chapter and the title of the section for the current page.

Indexes the chapter number.

The right side of each page indexes the chapter number for the page currently opened.

The diagram shows a page from the manual with several callout boxes explaining its layout:

- Manual Title:** A dashed box at the top left highlights the text "FX3U-20SSC-H Positioning Block User's Manual".
- Chapter and Section Title:** A dashed box at the top right highlights the text "8 Manual Control" and "8.1 Mechanical Zero Return Control".
- Table of Contents:** A vertical bar on the right side of the page contains a list of numbered items (1-10) corresponding to the page's content: 1 Introduction, 2 System Configuration, 3 Example Connection, 4 Installation, 5 Wiring, 6 Memory Allocation and Data, 7 Before Starting Control, 8 Manual Control, 9 Positioning Control, 10 Table Operation.
- Reference:** A callout box points to a specific line in the text: "→ For details on the DOG type mechanical zero return, refer to Subsection 8.1.2". The text explains that the "→" mark indicates a reference destination and reference manual.

The main content of the page includes:

- 8. Manual Control**
- 8.1 Mechanical Zero Return Control**
- 8.1.1 Outline of mechanical zero return control**
- The mechanical zero return method for the 20SSC-H includes the following three variations (four modes).
 - For related parameters, control data and monitor data, refer to Subsection 8.1.5
 - DOG type mechanical zero return (1 mode)
 - The position after stopping from the DOG signal with the zero signal of the servomotor becomes the zero-point.
 - For details on the DOG type mechanical zero return, refer to Subsection 8.1.2
 - Data-set type mechanical zero return (1 mode)
 - The position after moving with the JOG operation or manual pulse generator is defined as the zero-point.
 - For details on the data-set type mechanical zero return, refer to Subsection 8.1.3
 - Stopper type mechanical zero return (2 modes)
 - The stopper position is defined as the zero-point.
 - For details on the stopper type mechanical zero return, refer to Subsection 8.1.4
- 1. Mechanical zero return operation**
 - The mechanical zero return operation varies according to the zero return mode. For details, refer to the following.
 - For details on the DOG type mechanical zero return, refer to Subsection 8.1.2
 - For details on the data-set type mechanical zero return, refer to Subsection 8.1.3
 - For details on the stopper type mechanical zero return, refer to Subsection 8.1.4
 - 1) Turn the mechanical zero return command from OFF to ON to execute mechanical zero return.
 - 2) After calibrating the zero-point, the mechanical zero-point address from the positioning parameters is written to the current address.
 - 3) The zero return complete flag turns ON.
- Note**
 - The zero return command is not accepted if the zero-point pass signal servo status is OFF. Before executing zero return, be sure to rotate the servomotor at least once to turn the zero-point pass signal ON. The zero-point pass signal turns ON when the motor passes the motor reference position signal (Z-phase). To execute zero return immediately after power-on, specify "1: Motor Z-phase pass unnecessary after power-on" (default setting) at the servo parameter function selection C-4. With this setting, the zero-point pass signal turns ON even if the motor does not pass the zero-point (Z-phase).
 - With the simultaneous start flag ON, the X-axis mechanical zero return command simultaneously starts the X and Y-axes mechanical zero return operation. (The 20SSC-H ignores the Y-axis mechanical zero return command.)
- 2. Zero return complete flag**
 - The zero return complete flag turns ON (sets) when the mechanical zero return operation finishes. It turns OFF (resets) when reactivating the mechanical zero return command, or when turning the power OFF.

The page number "64" is located at the bottom left.

The above is different from the actual page, as it is provided for explanation only.

1. Introduction

1.1 Outline

The FX3U-20SSC-H type positioning block (hereinafter referred to as 20SSC-H) is a special function block applicable to SSCNET III.
20SSC-H can perform positioning control by servo motor via an SSCNET III applied servo amplifier.

1. 2-axis control is possible

One 20SSC-H controls 2 axes.

20SSC-H applies the 1-speed positioning and interrupt 1-speed constant quantity feed operations for constant quantity feed control, and also the linear interpolation and circular interpolation operations.

→ For positioning control, refer to Chapter 9

2. Connection to servo amplifier by SSCNET III is possible

- The 20SSC-H connects directly to the MELSERVO (our company's servo amplifier: MR-J3-□ B, MR-J3W-□ B*¹, MR-J3-□ BS*², MR-J4-□ B*³, MR-J4W2-□ B*³) via SSCNET III.

*1. The MR-J3W-□ B can be connected within the functional range of the MR-J3-□ B.

*2. The MR-J3-□ BS can be connected to the 20SSC-H Ver.1.40 or later.
However, it does not support the fully closed loop system.

*3. The MR-J4(W2)-□ B can be connected within the functional range of the "J3 compatibility mode".
When an MR-J4(W2)-□ B Series servo amplifier in factory default settings is connected to the 20SSC-H, the "J3 compatibility mode" is automatically selected.
If the "J4 mode" is already selected, it is not changed automatically to the "J3 compatibility mode".
Change the setting to the "J3 compatibility mode" using the application "MR-J4(W)-B mode selection" attached to MR Configurator2.

- Connection using the SSCNET III cable between the 20SSC-H and the servo amplifier reduces wiring. (Maximum length is 50m.)
- With SSCNET III cables (optical communication), connections are less susceptible to electromagnetic noise, etc. from the servo amplifier.
- Setting the servo parameters on the 20SSC-H side and writing/reading the servo parameters to/from the servo amplifier using SSCNET III is possible.
- Current values and error descriptions from the servo amplifier can be checked with the buffer memories of the 20SSC-H.

3. Easy application of absolute position detection system

- The servo amplifier with absolute position detection enables the absolute positioning detection system.
- Once the zero position is established, the zero return operation at power startup is not necessary.
- The absolute position system allows establishment of the zero position by the data set type zero return. In this case, wiring for near-point DOG, etc. is not required.

4. Easy maintenance

Various data such as positioning data, parameters, etc. can be saved to the flash memory (ROM) in the 20SSC-H.

This allows the data to be saved without a battery.

5. Connectable PLC

- The connected FX3U or FX3UC PLC reads/writes the positioning data from/to the 20SSC-H.
- For connection to the FX3UC PLC, the FX2NC-CNV-IF or FX3UC-1PS-5V is needed.

1

Introduction

2

System
configuration

3

Specifications

4

Installation

5

Wiring

6

Memory Config.
and data
operation

7

Before starting
positioning
operation

8

Manual control

9

Positioning
Control

10

Table Operation

1.2 External Dimensions and Part Names

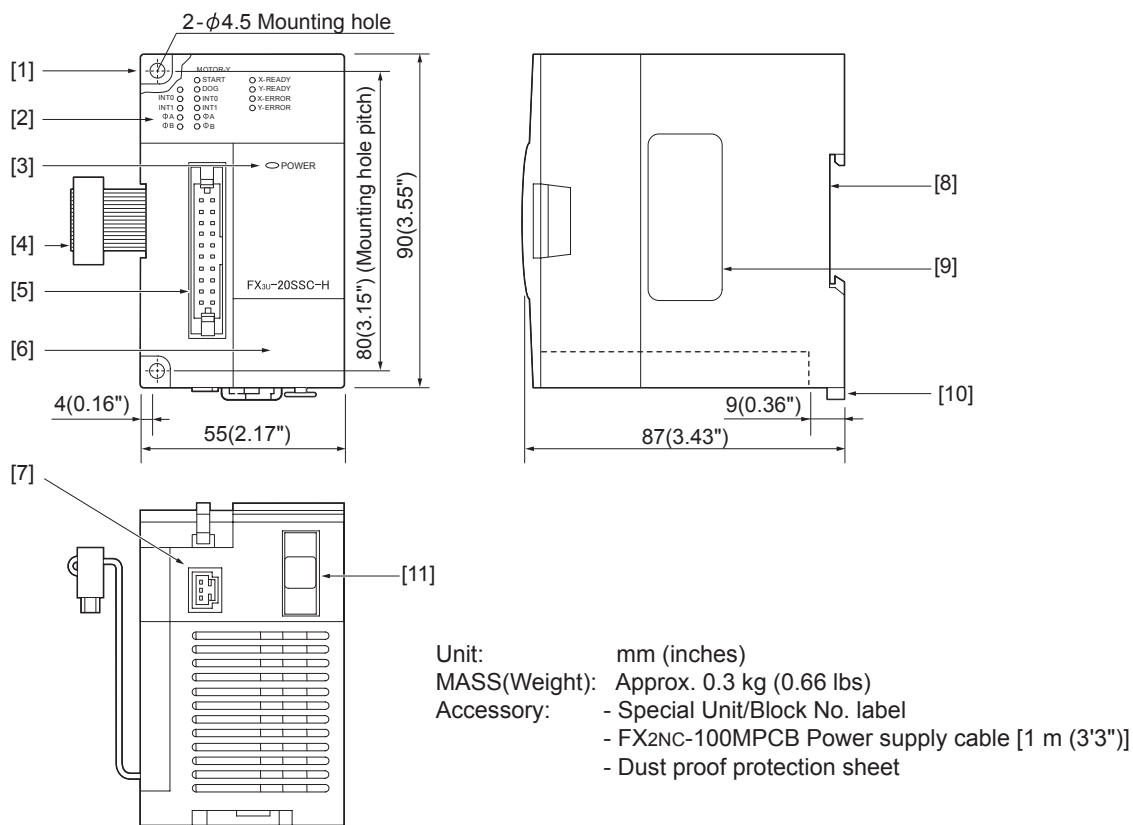

[1] Direct mounting hole: 2 holes of ϕ 4.5 (0.18") (mounting screw: M4 screw)

[2] Status LEDs

→ Refer to Section 1.3

[3] POWER LED (green)

[4] Extension cable

[5] Input connector

[6] Top cover

[7] Power supply connector

[8] DIN rail mounting groove [DIN rail: DIN46277 35 mm (1.38") wide]

[9] Name plate

[10] DIN rail mounting hook

[11] SSCNET III connector

1.3 Power and Status LED

LED display	Color	Status	Description
POWER	Green	OFF	Power is not being supplied from the external power supply or the PLC
		ON	Power is being supplied from the external power supply or the PLC
X-READY Y-READY	Green	OFF	Error is occurring or positioning is being executed on the X/Y axis
		ON	Various operation commands are acceptable on the X/Y axis
X-ERROR Y-ERROR	Red	OFF	X/Y axis is operating normally
		Flicker	Error is occurring on the X/Y axis
		ON	CPU error is occurring on the X/Y axis
X-START Y-START	Red	OFF	Start input OFF
		ON	Start input ON
X-DOG Y-DOG	Red	OFF	DOG input OFF
		ON	DOG input ON
X-INT0 Y-INT0 X-INT1 Y-INT1	Red	OFF	Interrupt input OFF
		ON	Interrupt input ON
X- ϕ A Y- ϕ A	Red	OFF	Manual pulse generator A-phase input OFF
		ON	Manual pulse generator A-phase input ON
X- ϕ B Y- ϕ B	Red	OFF	Manual pulse generator B-phase input OFF
		ON	Manual pulse generator B-phase input ON

1

Introduction

2

System
configuration

3

Specifications

4

Installation

5

Wiring

6

Memory Config.
and data
operation

7

Before starting
positioning
operation

8

Manual control

9

Positioning
Control

10

Table Operation

2. System Configuration

2.1 General Configuration

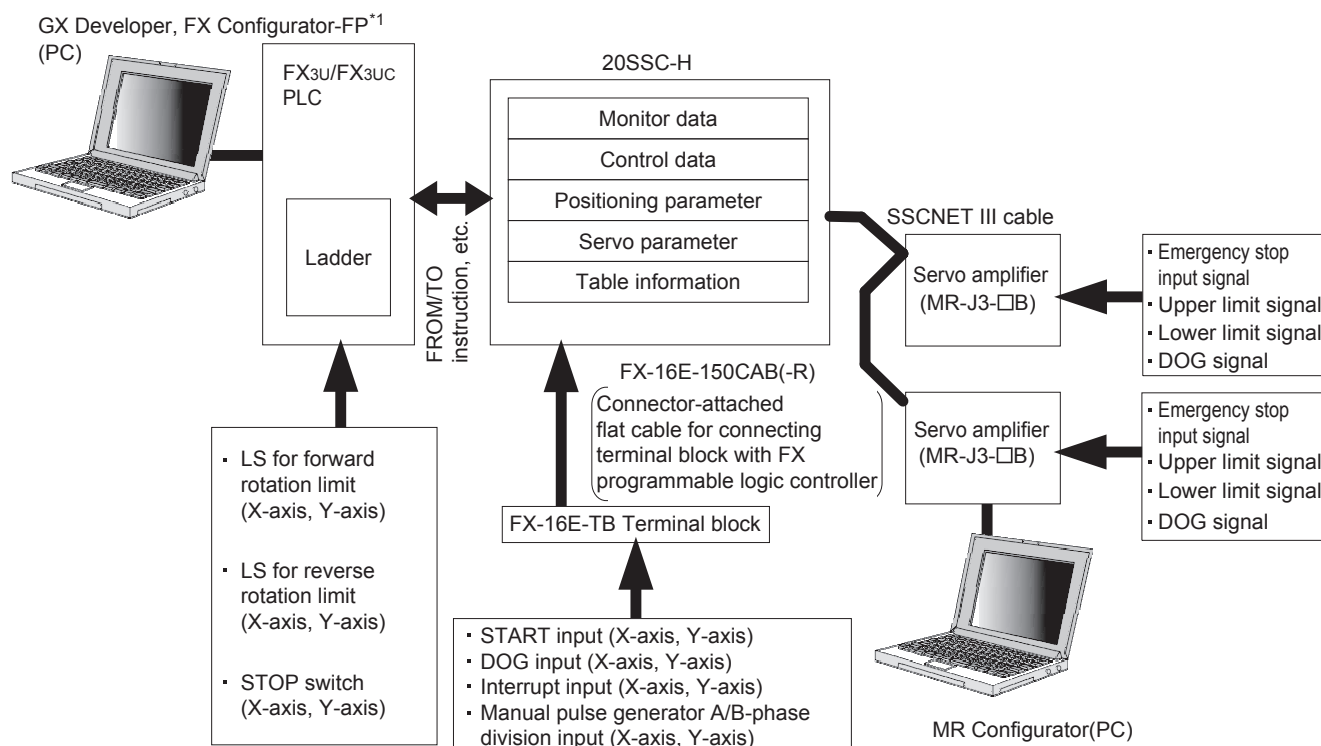

Component list

Part name	Model name	Remarks
Positioning block	FX3U-20SSC-H	-
PLC	FX3U/FX3UC PLC	-
PC software	GX Works2	PLC programming software
	GX Developer	
	FX Configurator-FP*1	Setting/Monitoring software for setting or monitoring the servo parameters, positioning parameters and table information
	MR Configurator2	Servo amplifier set-up software
	MR Configurator	
Servo amplifier	MR-J3-□B, MR-J3W-□B*2, MR-J3-□BS*3, MR-J4-□B*4, MR-J4W2-□B*4	-
SSCNET III cable	Inside panel standard code : MR-J3BUS □M	□ : 015/03/05/1/3(Cable length: in meters)
	Outside panel standard cable : MR-J3BUS □ M-A	□ : 5/10/20(Cable length: in meters)
	Long distance cable : MR-J3BUS □M-B	□ : 30/40/50(Cable length: in meters)
Terminal block	FX-16E-TB	-
I/O cable	FX-16E-□CAB	□ : 150/300/500
	FX-16E-□CAB-R	Cable length 150:1.5m, 300:3m, 500:5m

*1. Connection via the FA transparent function of the GOT1000 (only the GT15 and GT11 Series) is enabled in FX Configurator-FP Ver. 1.30 or later.

*2. The MR-J3W-□B can be connected within the functional range of the MR-J3-□B.

*3. The MR-J3-□BS can be connected to the 20SSC-H Ver.1.40 or later. However, it does not support the fully closed loop system.

*4. The MR-J4(W2)-□B can be connected within the functional range of the "J3 compatibility mode".

2.2 Connection with PLC

20SSC-H connects with PLC via extension cable.

The 20SSC-H is handled as a special extension block of the PLC. The unit number of the 20SSC-H is automatically assigned No.0 to No.7*1 starting from the special function unit/block closest to the PLC main unit. (This unit number is used for the designation of a FROM/TO instruction.) For details on assignment of the I/O number and unit number of the PLC, refer to the following manual corresponding to the connected PLC.

*1. When connecting to the FX3UC-32MT-LT(-2), the unit number is No. 1 to No. 7.

→ FX3u Hardware Edition
→ FX3uc Hardware Edition

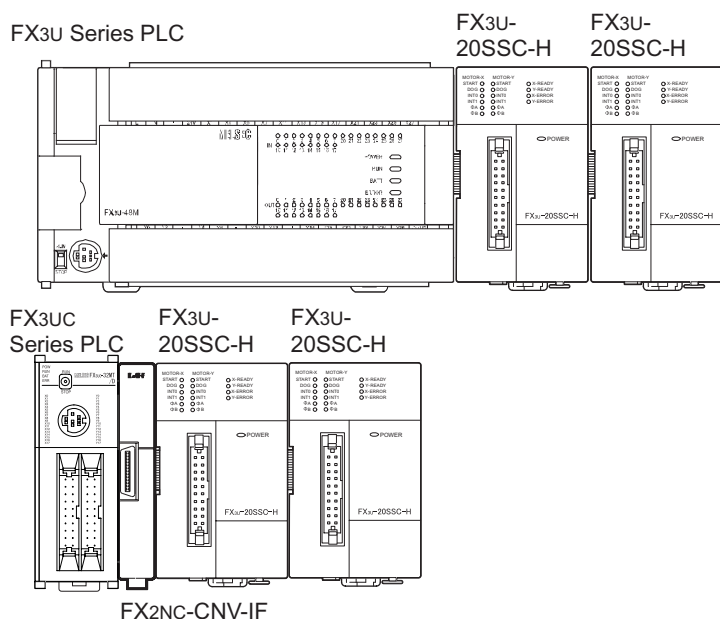

• The maximum number of 20SSC-H connectable to one PLC shows below.

Connected PLC		Maximum number of connectable units
FX3U Series PLC		8 units
FX3UC Series PLC*2	FX3UC (D,DS,DSS)	8 units
	FX3UC-32MT-LT, FX3UC-32MT-LT-2	7 units

*2. An FX2NC-CNV-IF or FX3UC-1PS-5V is necessary to connect the 20SSC-H with the FX3UC PLC.

- The optional FX0N-65EC (FX0N-30EC) and FX2N-CNV-BC are necessary to lengthen the extension cable.
- The number of I/O points occupied by the 20SSC-H is eight. Be sure that the total of the number of I/O points (occupied I/O points) of the main unit, power extension unit and extension block and the number of points occupied by the special function block does not exceed the maximum number of I/O points of the PLC.

For the maximum number of I/O points of the PLC, refer to the following manual.

→ FX3u Hardware Edition
→ FX3uc Hardware Edition

2.3 Applicable PLC

Model name	Applicability
FX3U Series PLC	Ver. 2.20 (from the first product) and later
FX3UC Series PLC*3	FX3UC (D,DS,DSS) Series PLC
	FX3UC-32MT-LT, FX3UC-32MT-LT-2

The version number can be checked by monitoring the last three digits of D8001/D8101.

*3. An FX2NC-CNV-IF or FX3UC-1PS-5V is necessary to connect the 20SSC-H with the FX3UC PLC.

3. Specifications

DESIGN PRECAUTIONS	 WARNING
<ul style="list-style-type: none"> • Make sure to have the following safety circuits outside of the PLC to ensure safe system operation even during external power supply problems or PLC failure. Otherwise, malfunctions may cause serious accidents. <ol style="list-style-type: none"> 1) Most importantly, have the following: an emergency stop circuit, a protection circuit, an interlock circuit for opposite movements (such as normal vs. reverse rotation), and an interlock circuit (to prevent damage to the equipment at the upper and lower positioning limits). 2) Note that when the PLC CPU detects an error, such as a watchdog timer error, during self-diagnosis, all outputs are turned off. Also, when an error that cannot be detected by the PLC CPU occurs in an input/output control block, output control may be disabled. External circuits and mechanisms should be designed to ensure safe machinery operation in such a case. 3) Note that when an error occurs in a relay, triac or transistor output device, the output could be held either on or off. For output signals that may lead to serious accidents, external circuits and mechanisms should be designed to ensure safe machinery operation in such a case. • At Forward/Reverse rotation limits, make sure to wire the contacts with NC, negative-logic. Wiring contacts with NO, positive-logic may cause serious accidents. 	

DESIGN PRECAUTIONS	 CAUTION
<ul style="list-style-type: none"> • Make sure to observe the following precautions in order to prevent any damage to the machinery or accidents due to abnormal data written to the PLC under the influence of noise: <ol style="list-style-type: none"> 1) Do not bundle the main circuit line together with or lay it close to the main circuit, high-voltage line or load line. Otherwise, noise disturbance and/or surge induction are likely to take place. As a guideline, lay the control line at least 100mm (3.94") or more away from the main circuit or high-voltage lines. 2) Ground the shield wire or shield of the shielded cable at one point on the PLC. However, do not ground them at the same point as the high-voltage lines. • Install module so that excessive force will not be applied to the built-in programming port, input connectors, power connectors or optical connectors. Failure to do so may result in wire damage/breakage or PLC failure. 	

DISPOSAL PRECAUTIONS	 CAUTION
<ul style="list-style-type: none"> • Please contact a certified electronic waste disposal company for the environmentally safe recycling and disposal of your device. 	

TRANSPORTATION AND STORAGE PRECAUTIONS	 CAUTION
<ul style="list-style-type: none"> • The PLC is a precision instrument. During transportation, avoid impacts larger than those specified in the general specifications of the PLC main unit manual by using dedicated packaging boxes and shock-absorbing palettes. Failure to do so may cause failures in the PLC. After transportation, verify operation of the PLC and check for damage of the mounting part, etc. 	

3.1 General Specifications

For items not listed below, specifications are equivalent to those of the PLC main unit.
For general specifications, refer to the manual of the PLC main unit.

→ Refer to FX3U Hardware Edition
→ Refer to FX3UC Hardware Edition

Item	Specification
Dielectric withstand voltage	500V AC for one minute
Insulation resistance	5MΩ or more by 500V DC Megger
Between all terminals and ground terminal	

3.2 Power Supply Specification

Item		Specification
External power supply	Power supply voltage	24V DC +20% -15% Ripple (p-p) within 5%
	Permitted instantaneous power failure time	Operation continues when the instantaneous power failure is 5ms or less.
	Power consumption	5W (220mA /24V DC)
	Power fuse	1A
Internal power supply	PLC power supply	100mA /5V DC

3.3 Performance Specification

Item		Specification
Number of control axes		2 axes
Backup		Positioning parameters, servo parameters, and table information can be saved to flash memory Write count: Maximum 100,000 times
Applicable PLC		FX3U/FX3UC ^{*1} Series PLC <ul style="list-style-type: none"> A maximum of 8 units/blocks can be connected with the FX3U/FX3UC (D, DS, DSS) Series PLC. A maximum of 7 units/blocks can be connected with the FX3UC-32MT-LT(-2) PLC.
No. of occupied I/O points		8 points (input or output, whichever may be counted)
Connectable servo amplifier		MELSERVO-J3-□B (Maximum 2 amplifiers can be connected), MELSERVO-J3W-□B ^{*2} (One amplifier can be connected), MELSERVO-J3-□BS ^{*3} (Maximum 2 amplifiers can be connected), MELSERVO-J4-□B ^{*4} (Maximum 2 amplifiers can be connected), MELSERVO-J4W2-□B ^{*4} (One amplifier can be connected) Standard cord length : Station to station maximum 20m (65'7") Long distance cord length : Station to station maximum 50m (164')
Servo bus		SSCNET III
Scan cycle		1.77ms
Control input		Interrupt input : 2 inputs (INT0 and INT1) per axis DOG : 1 input per input axis START input : 1 input per axis Manual pulse generator : 1 input per axis (A/B-phase)
Parameter		Positioning parameter : 27 types Servo parameter : 61 types
Control data		20 types
Monitor data		35 types
Positioning program		Created by sequence programs (using FROM/TO instruction, etc.) Direct operation (1 for X and Y axes respectively) Table operation (300 tables for X, Y, and XY axes respectively)
Positioning	Method	Increment/Absolute
	Unit	PLS, μm, 10 ⁻⁴ inch, mdeg
	Unit magnification	1, 10, 100, and 1000-fold
	Positioning range	-2,147,483,648 to 2,147,483,647 PLS
	Speed command	Hz, cm/min, inch/min, 10deg/min
	Acceleration/deceleration process	Trapezoidal acceleration/deceleration, S-pattern acceleration/deceleration: 1 to 5,000ms Only trapezoidal acceleration/deceleration is available for interpolation
	Starting time	1.6ms or less
	Interpolation function	2-axes linear interpolation, 2-axes circular interpolation

- *1. An FX2NC-CNV-IF or FX3UC-1PS-5V is necessary to connect the 20SSC-H with the FX3UC PLC.
*2. The MR-J3W-□B can be connected within the functional range of the MR-J3-□B.
*3. The MR-J3-□BS can be connected to the 20SSC-H Ver.1.40 or later.
However, it does not support the fully closed loop system.
*4. The MR-J4(W2)-□B can be connected within the functional range of the "J3 compatibility mode".

3.4 Input Specifications

3.4.1 Input specifications

Item		Specification
Input signal name	Group 1	X axis interrupt input: X-INT0, X-INT1 Used for interrupt operation
		Y axis interrupt input: Y-INT0, Y-INT1 Used for interrupt operation
		X axis near-point DOG input: X-DOG Used for zero return
		Y axis near-point DOG input: Y-DOG Used for zero return
		START command for X axis positioning operation: X-START
		START command for Y axis positioning operation: Y-START
	Group 2	Manual pulse generator input for X axis: X- ϕ A+/X- ϕ A-, X- ϕ B+/X- ϕ B- 1 edge count at 2-phase 2-count
		Manual pulse generator input for Y axis: Y- ϕ A+/Y- ϕ A-, Y- ϕ B+/Y- ϕ B- 1 edge count at 2-phase 2-count
	Group 3	External power supply for signals: S/S Connected to power supply for INT0, INT1, DOG and START
Group 1	Operation display	LED ON at input ON
	Signal voltage	24V DC +20% -15% (Power is supplied from S/S terminal)
	Input current	7.0mA \pm 1mA /24V DC
	ON current	4.5mA or more
	OFF current	1.5mA or less
	Signal form	No-voltage contact input Sink input: NPN open collector transistor Source input: PNP open collector transistor
	Response time	Hardware filter 1ms or less
	Circuit insulation	Photo-coupler insulation
Group 2	Operation display	LED ON at input ON
	Signal voltage	3 to 5.25V DC
	Input current	3.0 to 8.5mA
	ON current	3.0mA or more
	OFF current	0.5mA or less
	Signal form	Differential line driver (corresponding to AM26LS31)
	Response frequency	2-phases pulse 100KHz or less (Duty 50%)
	Circuit insulation	Photo-coupler insulation
Group 3	Power supply voltage	24V DC +20% -15%
	Consumption current	64mA or less

3.4.2 Internal input circuit

For the internal input circuit diagram, refer to the following.

→ For the internal input circuit diagram, refer to Section 5.3

3.5 Pin Configuration

3.5.1 Input connector

Connector pin array (aperture side)

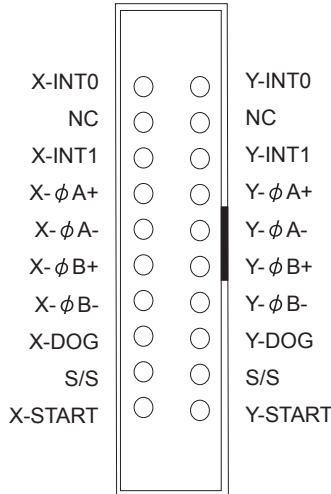

Terminal name	Description	Terminal name	Description
X-INT0	Interrupt input (for X axis)	Y-INT0	Interrupt input (for Y axis)
NC	Not used	NC	Not used
X-INT1	Interrupt input (for X axis)	Y-INT1	Interrupt input (for Y axis)
X-φA+	Input terminal for A-phase input of the manual pulse generator (2-phase pulse) (for X axis)	Y-φA+	Input terminal for A-phase input of the manual pulse generator (2-phase pulse) (for Y axis)
X-φA-	Common terminal for A-phase input of the manual pulse generator (2-phase pulse) (for X axis)	Y-φA-	Common terminal for A-phase input of the manual pulse generator (2-phase pulse) (for Y axis)
X-φB+	Input terminal for B-phase input of the manual pulse generator (2-phase pulse) (for X axis)	Y-φB+	Input terminal for B-phase input of the manual pulse generator (2-phase pulse) (for Y axis)
X-φB-	Common terminal for B-phase input of the manual pulse generator (2-phase pulse) (for X axis)	Y-φB-	Common terminal for B-phase input of the manual pulse generator (2-phase pulse) (for Y axis)
X-DOG	Near-point DOG input terminal (for X axis)	Y-DOG	Near-point DOG input terminal (for Y axis)
S/S	Power input terminal (START, DOG, INT0 and INT1) 24VDC Pins that have the same name (S/S) are shorted inside.	S/S	Power input terminal (START, DOG, INT0 and INT1) 24VDC Pins that have the same name (S/S) are shorted inside.
X-START	START input terminal (for X axis)	Y-START	START input terminal (for Y axis)

Caution

The pin array is seen from the connection side (aperture side) of the input connectors of the 20SSC-H. The pin numbers and the position of ▲ vary depending on the connectors for user cables. Perform proper wiring while paying attention to the position of notches and the direction of connectors. Otherwise, the product may be damaged due to wiring mistakes.

3.5.2 Power supply connector

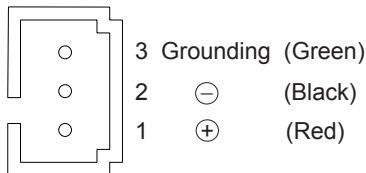

- 1 Introduction
- 2 System configuration
- 3 Specifications
- 4 Installation
- 5 Wiring
- 6 Memory Config and data operation
- 7 Before starting positioning operation
- 8 Manual control
- 9 Positioning Control
- 10 Table Operation

4. Installation

INSTALLATION PRECAUTIONS



WARNING

- Make sure to cut off all phases of the power supply externally before attempting installation or wiring work. Failure to do so may cause electric shock or damage to the product.

INSTALLATION PRECAUTIONS



CAUTION

- Connect the extension cables, peripheral device cables and input cables securely to their designated connectors. Loose connections may cause malfunctions.
- Use the product within the generic environment specifications described in section 3.1 of this manual. Never use the product in areas with excessive dust, oily smoke, conductive dusts, corrosive gas (salt air, Cl₂, H₂S, SO₂ or NO₂), flammable gas, vibration or impacts, or expose it to high temperature, condensation, or rain and wind. If the product is used in such conditions, electric shock, fire, malfunctions, deterioration or damage may occur.
- Do not touch the conductive parts of the product directly. Doing so may cause device failures or malfunctions.
- Install the product securely using a DIN rail or mounting screws.
- Install the product on a flat surface. If the mounting surface is rough, undue force will be applied to the PC board, thereby causing nonconformities.
- When drilling screw holes or wiring, make sure that cutting and wiring debris do not enter the ventilation slits. Failure to do so may cause fire, equipment failures or malfunctions.
- Be sure to remove the dust proof sheet from the ventilation slits of product when installation work is completed. Failure to do so may cause fire, equipment failures or malfunctions.
- Make sure to attach the top cover, before turning on the power or initiating operation after installation or wiring work. Failure to do so may cause electric shock.

The product can be connected on the right side of the main unit or extension unit/block. To connect to the FX3UC PLC or FX2NC PLC extension block, the FX2NC-CNV-IF or FX3UC-1PS-5V is necessary. For the installation environment, refer to the following respective manual.

→ **Refer to the FX3U Hardware Edition**

→ **Refer to the FX3uc Hardware Edition**

20SSC-H may be installed in a control cabinet with a 35 mm wide DIN46277 DIN rail mounting or M4 screw direct mounting.

4.1 DIN rail Mounting

The product may be mounted on a 35mm wide DIN46277 (DIN rail).

1 Fit the upper edge (A in the figure to the right) of the DIN rail mounting groove onto the DIN rail.

2 Push the product onto the DIN rail.

- An interval space between each unit of 1 to 2 mm (0.04" to 0.08") is necessary.

3 Connect the extension cable.

Connect the extension cable (B in the figure to the right) to the main unit, I/O extension unit/block or special function unit/block on the left side of the product.

For the extension cable connection procedure, refer to the following respective PLC manual.

- Refer to the FX3U Hardware Edition
- Refer to the FX3uc Hardware Edition

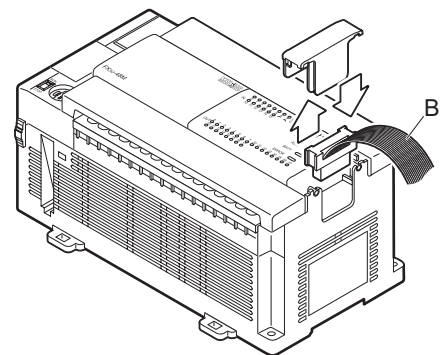
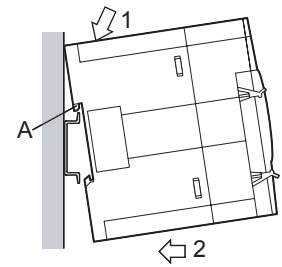

4.2 Direct Mounting

The product can be installed directly with screws.

An interval space between each unit of 1 to 2 mm (0.04" to 0.08") is necessary.

For installation, refer to the following respective PLC manual.

- For mounting hole pitches, refer to Section 1.2
- Refer to the FX3U Hardware Edition
- Refer to the FX3UC Hardware Edition

1 Make mounting holes in the mounting surface according to the external dimensions diagram.

2 Fit 20SSC-H (A in the figure to the right) to holes and tighten M4 screws (B in the figure to the right).

For the screw position and quantity, refer to the dimensioned drawing specified below.

- For dimensions, refer to Section 1.2

3 Connect the extension cable.

Connect the extension cable to the main unit, I/O extension unit/block or special function unit/block on the left side of the product.

(Refer to Step 3 in Section 4.1.)

For extension cable connection procedure, refer to the following respective PLC manual.

- Refer to the FX3U Hardware Edition
- Refer to the FX3uc Hardware Edition

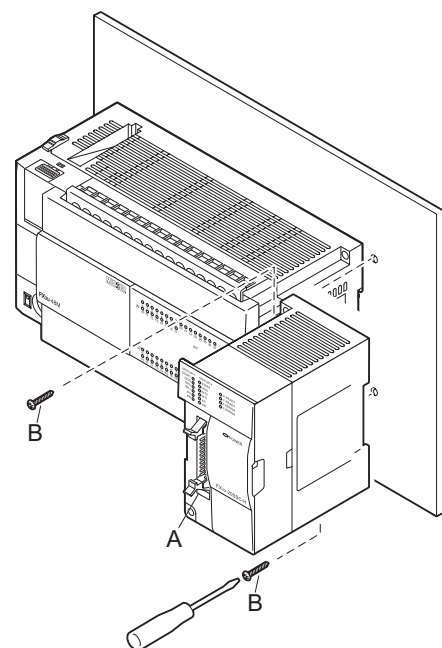

5. Wiring

DESIGN PRECAUTIONS



- Make sure to observe the following precautions in order to prevent any damage to the machinery or accidents due to abnormal data written to the PLC under the influence of noise:
 - 1) Do not bundle the main circuit line together with or lay it close to the main circuit, high-voltage line or load line. Otherwise, noise disturbance and/or surge induction are likely to take place. As a guideline, lay the control line at least 100mm (3.94") or more away from the main circuit or high-voltage lines.
 - 2) Ground the shield wire or shield of the shielded cable at one point on the PLC. However, do not ground them at the same point as the high-voltage lines
- Install module so that excessive force will not be applied to the built-in programming port, input connectors, power connectors or optical connectors. Failure to do so may result in wire damage/breakage or PLC failure.

WIRING PRECAUTIONS



- Make sure to cut off all phases of the power supply externally before attempting installation or wiring work. Failure to do so may cause electric shock or damage to the product.

WIRING PRECAUTIONS



- Connect the PC power supply wiring to the dedicated terminals described in this manual. If an AC power supply is connected to a DC input terminal or DC power supply terminal, the product will burn out.
- Perform class D grounding (grounding resistance: 100Ω or less) to the grounding terminal on the 20SSC-H with a wire as thick as possible. Do not use common grounding with heavy electrical systems (refer to subsection 5.2.2).
- Make sure to attach the top cover, before turning on the power or initiating operation after installation or wiring work. Failure to do so may cause electric shock.
- Connect the inputs of the 20SSC-H to the dedicated connectors described in this manual. If an AC power supply is connected to a DC input terminal or DC power supply terminal, the product will burn out.
- Do not wire vacant terminals externally. Doing so may damage the product.
- When drilling screw holes or wiring, make sure cutting or wire debris do not enter the ventilation slits. Failure to do so may cause fire, equipment failures or malfunctions.
- Make sure to properly wire to the FX Series terminal blocks in accordance with the following precautions. Failure to do so may cause electric shock, equipment failures, a short-circuit, wire breakage, malfunctions, or damage to the product.
 - The disposal size of the cable end should follow the dimensions described in the manual of the PLC main unit.
 - Tightening torque should follow the specifications in the manual of the PLC main unit.
- Do not wire or bundle the SSCNET III cables together with or lay them near a main circuit cable, high-voltage line, or load lines separate from the PLC. As a guideline, lay the SSCNET III cables at least 100mm (3.94") or more away from power lines. Failure to do so may cause surge induction and/or noise disturbance.
- Optical fiber end face defects that are caused from contaminants may deteriorate the signal transmission rate and cause malfunction. When removing the SSCNET III cabling from the 20SSC-H port, make sure to attach the protective caps to the cable connectors and ports.
- Do not remove the SSCNET III cable from its port while the power is ON for the 20SSC-H or Servo Amp. Do not look directly into the optical fiber cable ends or SSCNET III ports, as doing so may cause eye damage. (The laser for SSCNET III communication complies with Class 1 as defined in JISC6802 and IEC60825-1)
- When handling the SSCNET III cables, do not expose them to strong impact, lateral pressure, excessive pulling tension, abrupt bending or twisting. Failure to do so may crack the glass fiber and cause signal transmission loss. Note that a short SSCNET III cable is highly susceptible to twisting.
- Make sure to use the SSCNET III cable within the allowable temperature range (as shown in subsection 5.1.1). Do not expose the SSCNET III cabling to fire or excessive heat. Avoid contact with high temperature components such as the servo amplifier radiator, regenerative brake and servo motor.
- Do not force the SSCNET III cable into a bend radius smaller than the minimum allowable bend radius. (Refer to subsection 5.4.1 Precautions for the SSCNET III cable wiring.)
- Put the SSCNET III cable in the duct or fix the cable at the closest part to the 20SSC-H with bundle material in order to prevent SSCNET III cable from putting its own weight on SSCNET III connector. When laying cable, the optical cord should be given loose slack to avoid from becoming smaller than the minimum bend radius, and it should not be twisted. Also, fix and hold it in position with using cushioning such as sponge or rubber which does not contain plasticizing material. When using adhesive tape to bundle, use flame-resistant acetate cloth adhesive tape (e.g. 570F by Teraoka Seisakusho Co., Ltd.).

WIRING PRECAUTIONS

- Migrating plasticizer is used for vinyl tape. Keep the MR-J3BUS□M, and MR-J3BUS□M-A cables away from vinyl tape because the optical characteristic may be affected.
Generally, soft polyvinyl chloride (PVC), polyethylene resin (PE) and fluorine resin contain non-migrating plasticizer and they do not affect the optical characteristic of SSCNET III cable. However, some wire sheaths and cable ties, which contain migrating plasticizer (phthalate ester), may affect MR-J3BUS□M and MR-J3BUS□M-A cables.
In addition, MR-J3BUS□M-B cable is not affected by plasticizer.
- Exposing the SSCNET III cable to solvent/oil may deteriorate the optical fiber and alter its mechanical characteristics. When using the SSCNET III cable near solvent/oil, take protective measures to shield the SSCNET III cable.
- When storing the SSCNET III cable, attach the protective cap to the 20SSC-H connector port for dust protection.
- Do not remove the protective cap from the 20SSC-H connector port until just before connecting the SSCNET III cable. Attach the protective cap to the 20SSC-H connector port after removing the SSCNET III cable to protect the internal optical device from exposure to dust.
- Keep the protective cap and protective tubing clean, and always store them in the provided plastic bag when removing them from the hardware devices.
- When replacing the 20SSC-H, or when sending the product to your local Mitsubishi Electric representative for repair, make sure to attach the protective cap to the 20SSC-H connector port. Failure to do so may damage the internal optical device and require optical device replacement.

5.1 Cable to Be Used, Applicable Connector and Wire Size

5.1.1 SSCNET III cable

The SSCNET III cable for connecting 20SSC-H with the servo amplifier is described.

Model	Cable length	Flex Life	Operating temperature range	Application and remarks
MR-J3BUS□*1M	0.15, 0.3, 0.5, 1, 3m	Standard	-40 to 85 °C (-40 to 185 °F)	For standard in-panel code
MR-J3BUS□*1M-A	5, 10, 20m	Standard		For standard external cable
MR-J3BUS□*1M-B	30, 40, 50m	Long flex	-20 to 70 °C (-4 to 158 °F)	For long distance cable

*1. □ indicates the cable length.

015 : 0.15m, 03 : 0.3m, 05 : 0.5m, 1 : 1m, 3 : 3m, 5 : 5m, 10 : 10m, 20 : 20m, 30 : 30m, 40 : 40m, 50 : 50m

5.1.2 Power supply cable

The cable for connecting the 20SSC-H power supply connector with the power supply is described.

Model name	Length	Remarks
FX2NC-100MPCB	1m	Accessory of 20SSC-H

5.1.3 Input cable and terminal block

The cable for connecting the 20SSC-H input connector with external devices is described.

1. Input connector

The input connector of 20SSC-H complies with MIL-C-83503.

Procure the input cable while referring to the following.

- 1) Applicable connector (commercially available connectors)
Use the 20-pin (1-key) socket complying with MIL-C-83503.
Check in advance for interference with peripheral parts such as the connector cover.
- 2) Input cable (by Mitsubishi Electric)

Model name	Cable length	Remarks
FX-16E-□ ^{*1} CAB	1.5, 3, 5m	Flat cable (with tube) provided with a 20-pin connector at both ends
FX-16E-□ ^{*1} CAB-R		Round multi-conductor cable provided with a 20-pin connector at both ends
FX-16E-500CAB-S	5m	Bulk cable with 20-pin connector provided on a single end (cable color: red)

- *1. □ indicates the cable length.
150 : 1.5m, 300 : 3m, 500 : 5m

- 3) Applicable connector for user cable (by Mitsubishi Electric)
The user should prepare the electric wires and pressure crimp tool.

Model name and configuration of I/O connector				Applicable cable (UL-1061 recommended) and tool	
Our model name			Description of part (Made by DDK Ltd.)	Wire size	Crimp tool (Made by DDK Ltd.)
For flat cable	FX2C-I/O-CON	Set of 10 pieces	Crimp connector FRC2-A020-30S	AWG28 (0.1mm ²) 1.27 pitch 20 conductors	357J-46740: Main body 357J-4664N: Attachment
For united cable	FX2C-I/O-CON-S	Set of 5	Housing HU-200S2-001 Crimp contact HU-411S	AWG22 (0.3mm ²)	357J-5538
	FX2C-I/O-CON-SA	Set of 5	Housing HU-200S2-001 Crimp contact HU-411SA	AWG20 (0.5mm ²)	357J-13963

- 4) Applicable connectors (commercially available connectors)
DDK Ltd. connector specified in Item (3) above.

2. Terminal block

- 1) Terminal block (by Mitsubishi Electric)

For the specification and internal circuit of the terminal block, refer to the following respective PLC manual.

→ Refer to the FX3U Hardware Edition
→ Refer to the FX3UC Hardware Edition

Model name	Application and remarks
FX-16E-TB	Converts input connector to terminal block

- 2) Terminal layout of FX-16E-TB connected to input connector

→ For the pin array of the input connector, refer to Subsection 3.5.1

Y-START	.	X-φA+	S/S ^{*1}	X-φB+	X-DOG	S/S ^{*1}	.	Y-φA+	S/S ^{*1}	Y-φB+	Y-DOG	S/S ^{*1}
X-START	X-INT0	X-INT1	S/S ^{*1}	X-φA-	X-φB-	S/S ^{*1}	Y-INT0	Y-INT1	S/S ^{*1}	Y-φA-	Y-φB-	S/S ^{*1}

- *1. The S/S terminal is connected inside FX-16E-TB.

5.2 Power Supply Wiring

5.2.1 Power supply wiring

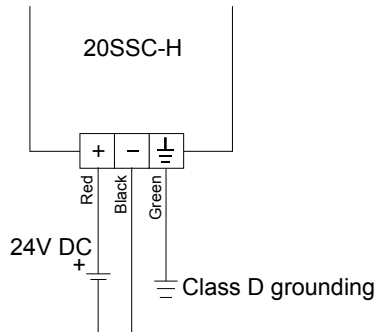

Power-on timing

The 20SSC-H power supply should be turned ON simultaneously or before the PLC main unit. Before turning the power OFF, ensure the safety of the system and then simultaneously turn the main unit, 20SSC-H, and other extension equipment (the special extension equipment is included) OFF. For details, refer to the following respective PLC manual.

→ Refer to the FX3U Hardware Edition
→ Refer to the FX3UC Hardware Edition

5.2.2 Grounding

Ground the cables as follows

- The grounding resistance should be 100Ω or less.
- Independent grounding should be established whenever possible. Independent grounding should be performed for best results. When independent grounding is not configured, perform "shared grounding" as shown in the following figure. For details, refer to the following respective PLC manual.

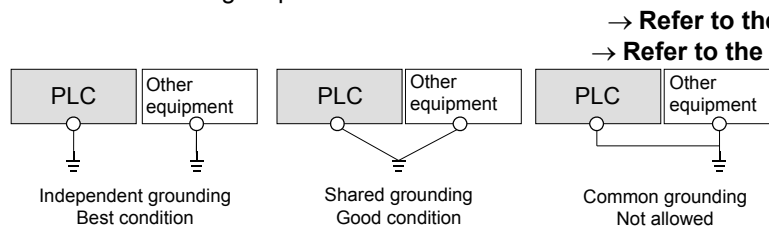

→ Refer to the FX3U Hardware Edition
→ Refer to the FX3UC Hardware Edition

- The grounding wire size should be AWG22-20 (0.3 to 0.5 mm²).
- The grounding point should be close to the PLC, and all grounding wires should be as short as possible.

5.3 Input Wiring

An external power supply (24VDC) is necessary for the START, DOG, INT0, INT1 and S/S terminals.

5.3.1 Sink input wiring

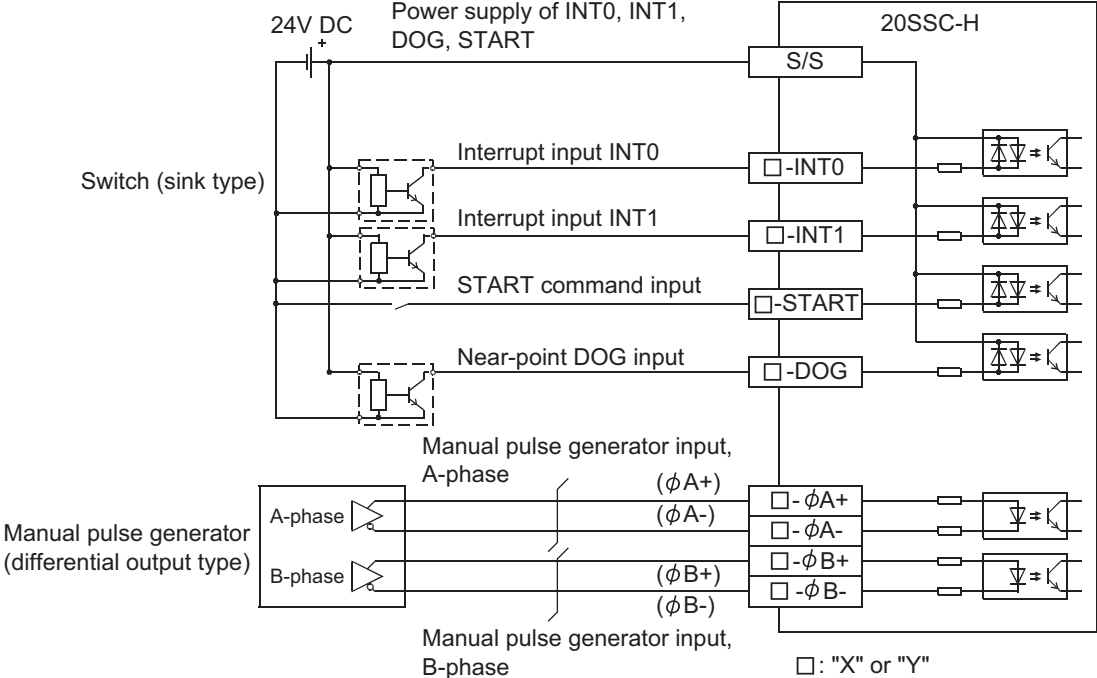

5.3.2 Source input wiring

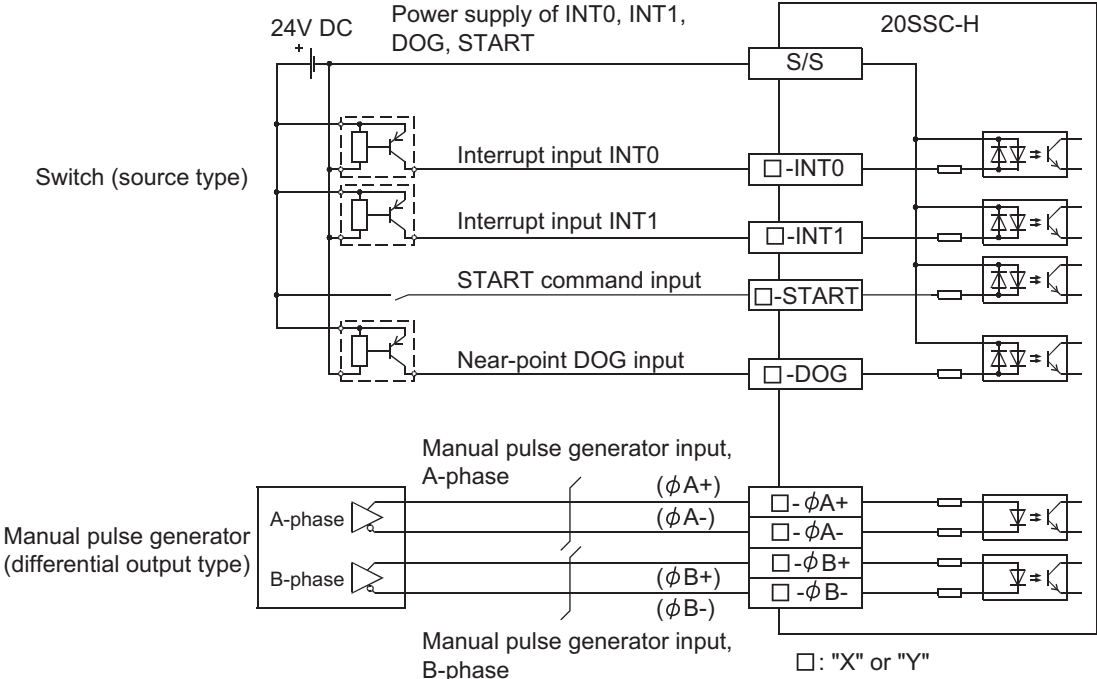

5.4 Connecting the SSCNET III Cabling

5.4.1 Cautions for installing the SSCNET III cabling

SSCNET III cables are made from optical fiber.

If force is applied to the optical fiber in the form of major shock, lateral pressure, haul, or sudden bending or twisting, the inside will distort or break, and optical transmission will cease.

Carefully read the precautions in this manual when handling the SSCNET III cable(s).

For detailed specifications on the SSCNET III cable(s) or details on the assembling procedure, refer to the following manual.

- Refer to the **MR-J3-□ B Servo Amplifier Instruction Manual**
- Refer to the **MR-J3W-□ B Servo Amplifier Instruction Manual**
- Refer to the **MR-J3-□ B Safety Servo Amplifier Instruction Manual**
- Refer to the **MR-J4-□ B Servo Amplifier Instruction Manual**
- Refer to the **MR-J4W2-□ B Servo Amplifier Instruction Manual**

1) Minimum bend radius

Make sure to lay the SSCNET III cable(s) with the minimum bend radius or more.

If the SSCNET III cable(s) has a smaller radius than the minimum bend radius, optical transmission is interrupted and may cause malfunction.

SSCNET III cable	Minimum bend radius [mm (inches)]
MR-J3BUS□ M	25 (0.98")
MR-J3BUS□ M-A	Reinforced film cable : 50 (1.97") Code part : 25 (0.98")
MR-J3BUS□ M-B	Reinforced film cable : 50 (1.97") Code part : 30 (1.18")

2) Tension

If tension is applied to the SSCNET III cable(s), the chance of transmission loss increases due to external forces on the fixing part of the SSCNET III cable(s) or the connecting part of the SSCNET connector. In the worst case, the SSCNET III cable(s) may break or become damaged. When laying SSCNET III cable(s), do not apply forced tension.

3) Lateral pressure

If lateral pressure is applied to the optical cable(s), the SSCNET III cabling itself distorts, the internal optical fiber gets stressed, and the chance for transmission loss increases. In the worst case, the SSCNET III cable(s) may break. To avoid lateral pressure while laying the cable(s), do not bind the SSCNET III cabling with nylon bands (TY-RAP).

4) Twisting

If the SSCNET III cabling is twisted, it has the same effect as applying when local lateral pressure or bending stress. Consequently, transmission loss increases, and in the worst case, the SSCNET III cable(s) may break.

1

Introduction

2

System
configuration

3

Specifications

4

Installation

5

Wiring

6

Memory Config.
and data
operation

7

Before starting
positioning
operation

8

Manual control

9

Positioning
Control

10

Table Operation

5.4.2 Cautions for SSCNET III cable wiring

Secure the cable close to the connector with bundle material in order to prevent the SSCNET III cable from applying its own weight to the connector.

Reserve the following distance when wiring.

1) Wiring duct

If the duct is below the bottom of the 20SSC-H, leave sufficient clearance to eliminate effects on the SSCNET III cable. The space height should be 70 mm (2.76") minimum.

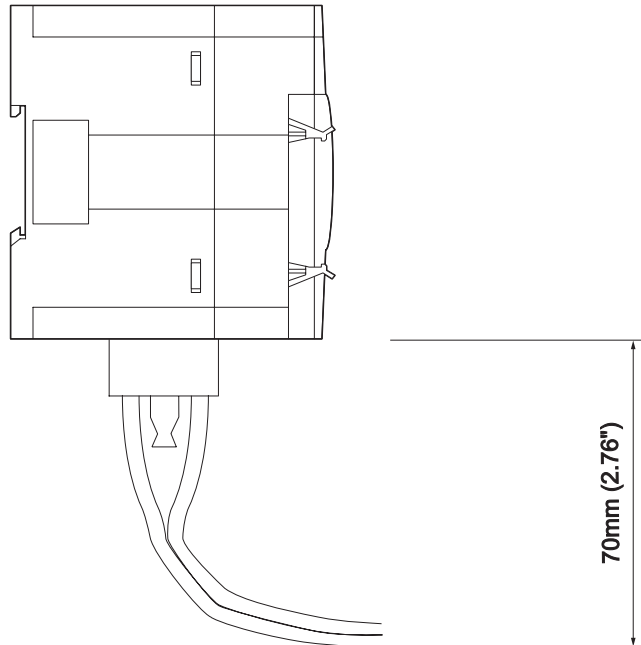

2) Bundling

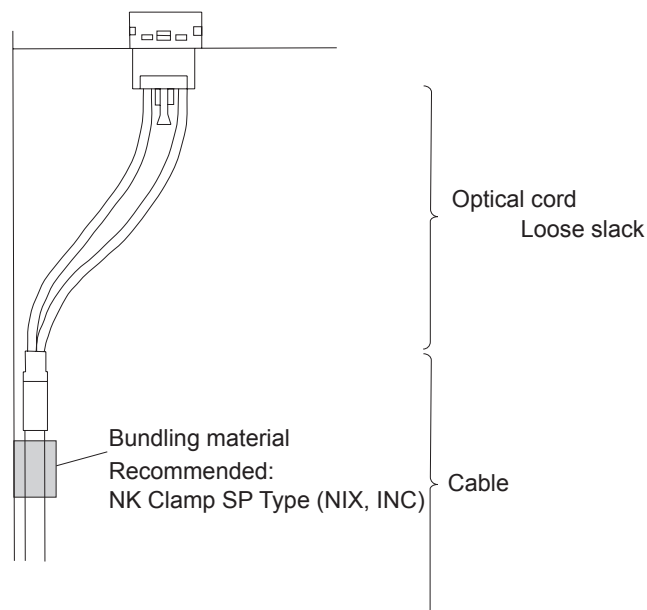

6. Memory Configuration and Data Operation

DESIGN PRECAUTIONS



- Make sure to observe the following precautions in order to prevent any damage to the machinery or accidents due to abnormal data written to the PLC under the influence of noise:
 - 1) Do not bundle the main circuit line together with or lay it close to the main circuit, high-voltage line or load line. Otherwise, noise disturbance and/or surge induction are likely to take place. As a guideline, lay the control line at least 100mm (3.94") or more away from the main circuit or high-voltage lines.
 - 2) Ground the shield wire or shield of the shielded cable at one point on the PLC. However, do not ground them at the same point as the high-voltage lines.
- Install module so that excessive force will not be applied to the built-in programming port, input connectors, power connectors or optical connectors. Failure to do so may result in wire damage/breakage or PLC failure.

STARTUP AND MAINTENANCE PRECAUTIONS



- Do not touch any terminal while the PLC's power is on. Doing so may cause electric shock or malfunctions.
- Before cleaning or retightening terminals, cut off all phases of the power supply externally. Failure to do so may cause electric shock.
- Before modifying or disrupting the program in operation or running the PLC, carefully read through this manual and the associated manuals and ensure the safety of the operation. An operation error may damage the machinery or cause accidents.
- Before operating the Zero-return/JOG or testing of the positioning data, carefully read through this manual and the associated manuals and ensure the safety of the operation. An operation error may damage the machinery or cause accidents.

STARTUP AND MAINTENANCE PRECAUTIONS



- Do not disassemble or modify the PLC. Doing so may cause fire, equipment failures, or malfunctions. For repair, contact your local Mitsubishi Electric representative.
- Turn off the power to the PLC before connecting or disconnecting any extension cable. Failure to do so may cause equipment failures or malfunctions.
- Turn off the power to the PLC before attaching or detaching the following devices. Failure to do so may cause equipment failures or malfunctions.
 - Peripheral devices, expansion boards, and special adapters
 - Extension units/blocks and FX Series terminal blocks

6.1 Memory Configuration and Role

6.1.1 Memory configuration

Store parameters and data necessary for control in the buffer memory (BFM) and flash memory inside the 20SSC-H using FX Configurator-FP (setting/monitoring tool)^{*1} or a sequence program.

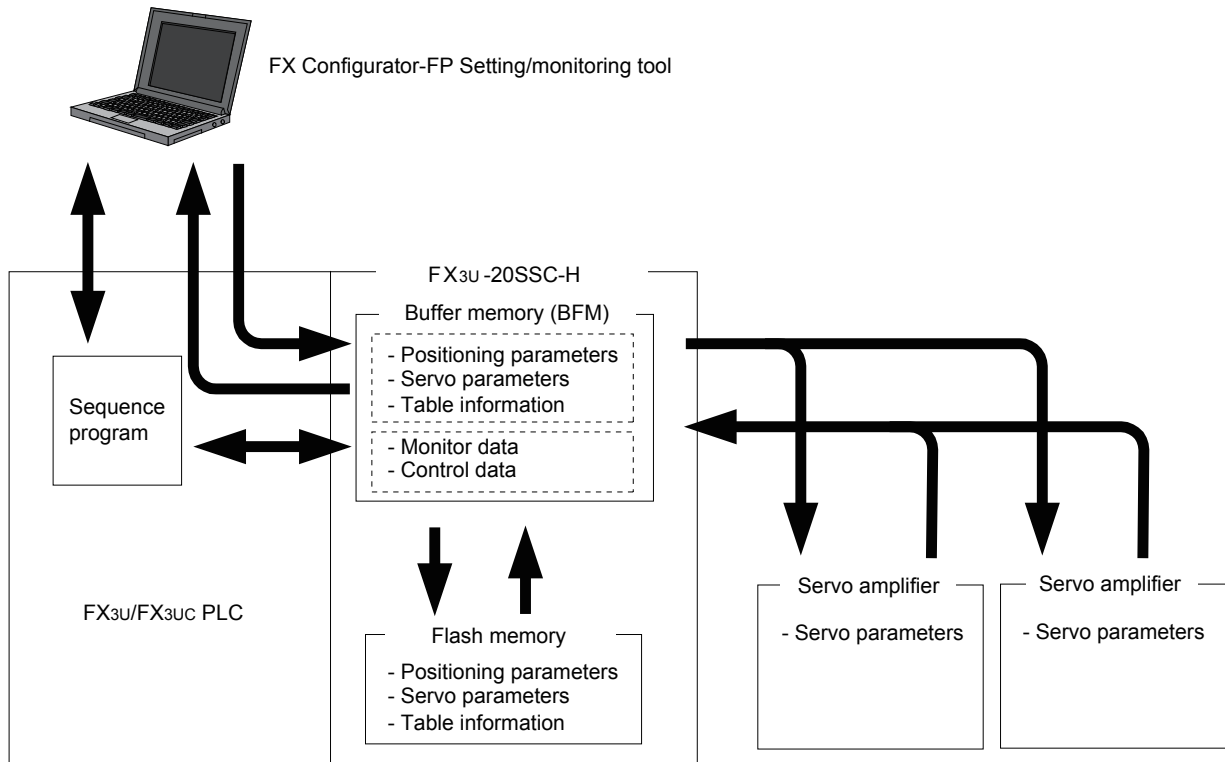

1) Buffer memory (BFM)

The PLC can access the buffer memory (BFM) directly, using sequence programs.

The 20SSC-H uses positioning parameters and data in this area to execute positioning control.

2) Flash memory

The flash memory saves parameters and table information necessary for positioning control.

Store necessary data in advance for the mechanical equipment and applications.

Servo parameters stored in the flash memory or buffer memory are transferred to the servo amplifier in accordance with the setting of positioning parameters. The servo amplifier will perform control using the transferred servo parameters. (In the 20SSC-H whose version is earlier than Ver.1.10, servo parameters stored in the flash memory are transferred to the servo amplifier.)

→ **For the parameter setting, refer to Section 7.1**

*1. FX Configurator-FP Ver. 1.30 or later can set parameters and data via the FA transparent function of the GOT1000 Series (only the GT15 and GT11 Series).

6.1.2 Data type and role

Data type	Application	BFM number		
		X-axis	Y-axis	X-Y-axis
Monitor data	Data indicating the control state. The monitor data is stored in the buffer memory. Monitor the data when necessary. → For details, refer to Section 11.3	BFM #0 to #99	BFM #100 to #199	-
Control data	The user controls the positioning control system, using the control data. The control data is related to operation-related settings, speed change command during positioning operation, stop operation, restart, etc. → For details, refer to Section 11.4	BFM #500 to #599	BFM #600 to #699	-
Positioning parameters	The positioning parameters specify the unit, speed and other features of the positioning control. Enter data according to the mechanical equipment and applicable motor. → For details, refer to Section 11.1	BFM #14000 to #14199	BFM #14200 to #14399	-
Servo parameters	The servo parameters depend on the servo amplifier to be used, and are used to control the servomotor. Enter data according to the specifications to be used. → For details, refer to Section 11.2	BFM #15000 to #15199	BFM #15200 to #15399	-
Table information	The table information is used for table type positioning control. Positioning control is based on the data specified in each table (operation information, position information, speed information, m code information). Up to 300 positioning table points per table can be defined. → For details, refer to Section 11.5	BFM #1000 to #3999	BFM #4000 to #6999	BFM #7000 to #12999

Note

- Positioning and servo parameters are automatically created and set for each of the X- and Y- axes according to the factory default settings. (Leave default parameters for unused axes.)
- The table information is created for each of the X-, Y- and XY-axes.
- The positioning parameters, servo parameters and table information can be initialized, using FX Configurator-FP or a sequence program.
 - For the initialization method using FX Configurator-FP, refer to Subsection 7.1.3 and the FX Configurator-FP OPERATION MANUAL
 - For initialization using a sequence program, refer to Subsection 7.1.6 and 11.4.15

6.2 Data Transfer Process

6.2.1 Data transfer processing among the PLC, 20SSC-H and servo amplifier

The data transfer between PLC, 20SSC-H, and servo amplifier is as follows.

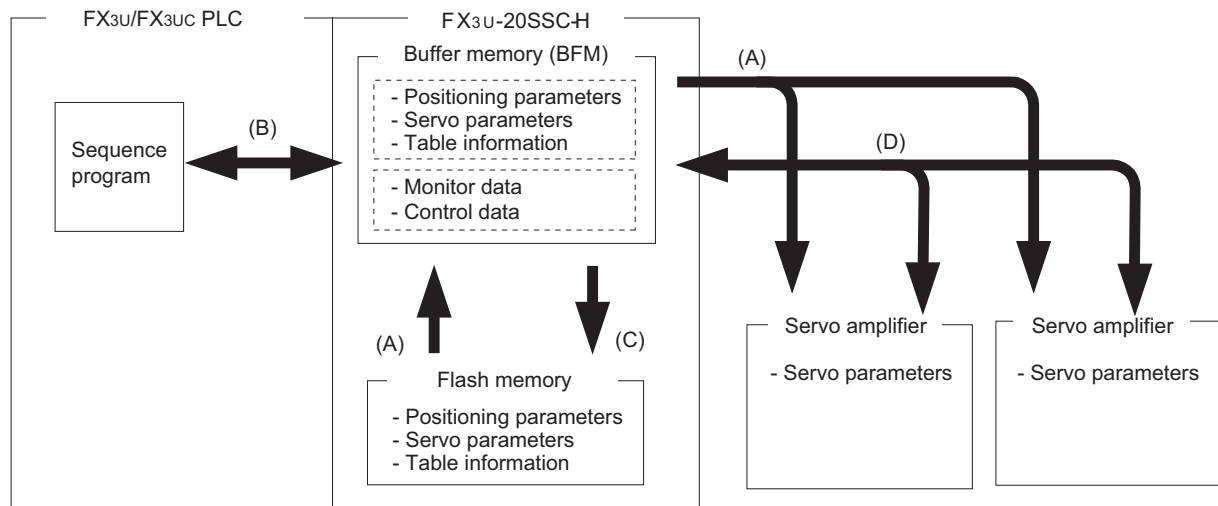

1. Power-on data transfer process [A in the figure above]

The following data transfer process occurs.

- 1) The data in the 20SSC-H flash memory is transferred to the buffer memory (BFM).
- 2) The servo parameters are transferred to the servo amplifier.

To transfer the servo parameters automatically to the servo amplifier at PLC power-on, set the following parameter in flash memory and turn the power ON in order from the servo amplifier to the 20SSC-H (including the PLC).

→ For details, refer to Subsection 6.2.3 and Section 7.1

- Save servo parameters that relate to the servo amplifier with the servo series (BFM #15000, #15200), to the flash memory.

2. Data transfer between PLC and buffer memory (BFM) of 20SSC-H [B in the figure above]

Applied instructions such as the MOV instruction, or the FROM/TO instruction are used to read/write parameters and data between the PLC and buffer memory.

Note

It is recommended to set positioning parameters, servo parameters and table information using FX Configurator-FP, and then save them in the flash memory.

If they are set using a sequence program, it is necessary to create a complicated sequence program and use many devices. As a result, the scan time will increase.

3. Writing data to the flash memory in 20SSC-H [C in the figure above]

To change data in the flash memory, use a sequence program or FX Configurator-FP to modify the buffer memory data, then activate a save command (BFM #523 b0 to b6) to save positioning parameters, servo parameters and table information from the buffer memory to the flash memory.

→ For the operation of FX Configurator-FP, refer to the FX Configurator-FP Operation Manual

→ For the flash memory save command, refer to Subsection 11.4.15

4. Data transfer process between 20SSC-H and servo amplifier [D in the figure above]

When servo parameters on the servo amplifier side are modified, the buffer memory of the 20SSC-H is (by default) automatically updated.

For the initial servo parameter transfer method, refer to the following.

→ For the initial servo parameter transfer methods, refer to Subsection 6.2.3 and Section 7.1

6.2.2 Data transfer processing between FX Configurator-FP and 20SSC-H

The data transfer between FX Configurator-FP and 20SSC-H via the PLC is as follows.

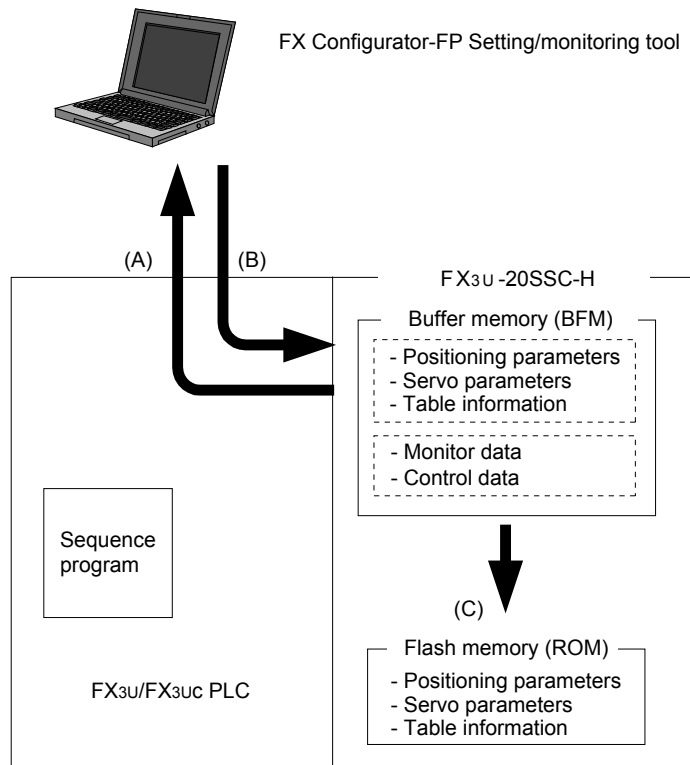

1. From 20SSC-H (buffer memory) to FX Configurator-FP [A in the figure above]

The following data is read from the buffer memory in 20SSC-H to FX Configurator-FP.

- Positioning parameters
- Servo parameters
- Table information
- Monitor data (operation status, action status, input signal status, etc.)

2. From FX Configurator-FP to 20SSC-H (buffer memory) [B in the figure above]

The following data is written from FX Configurator-FP to the buffer memory in 20SSC-H.

- Positioning parameters
- Servo parameters
- Table information
- Control data (new current values, speed change, operation test command, etc.)

3. From FX Configurator-FP (buffer memory in 20SSC-H) to 20SSC-H (flash memory) [C in the figure above]

The following data is saved from the buffer memory in 20SSC-H to the flash memory according to the save command sent from FX Configurator-FP.

- Positioning parameters
- Servo parameters
- Table information

6.2.3 Transfer (writing) servo parameters to servo amplifier

When the power is turned ON or when the system is reset*1, the 20SSC-H transfers servo parameters stored in the flash memory to the buffer memory.

When the servo series (BFM #15000, #15200) is set to the connected servo amplifier, the 20SSC-H transfers servo parameters to the servo amplifier.

The figure below shows how to transfer servo parameters to the servo amplifier.

→ For the parameter setting, refer to Section 7.1

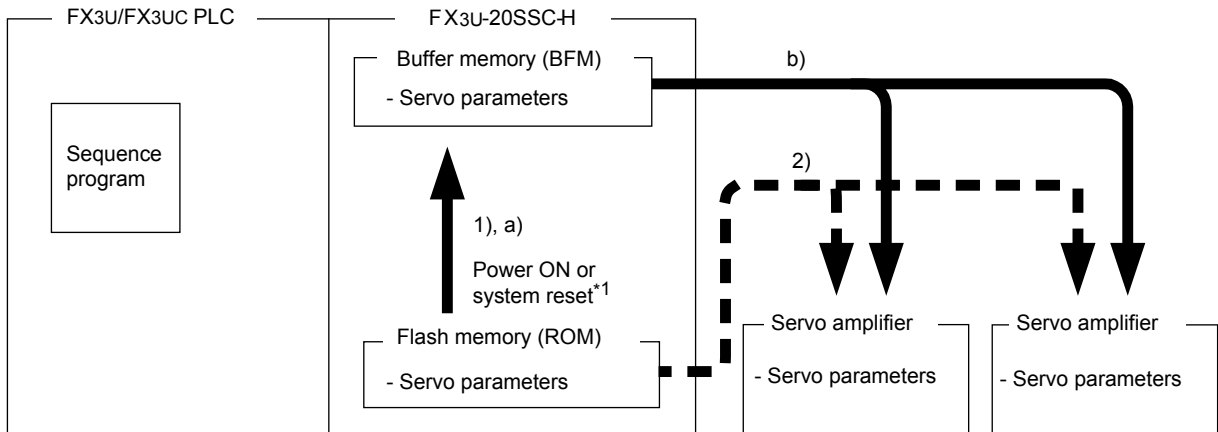

- How to transfer the servo parameters stored in the flash memory to the servo amplifier

→ For the parameter setting, refer to Section 7.1

Procedure (Transfer sequence: 1) and 2) in the above figure)

Store, in the flash memory, the servo series [BFM #15000 (X-axis) and #15200 (Y-axis)] set to the connected servo amplifier series and the servo parameter transfer mode (b15) set to OFF in the operation parameter 2 [BFM #14002 (X-axis) and #14202 (Y-axis)].

After turning the power ON or after executing the system reset command*1, the following events occur: (Turn ON the power to the amplifier first, and then to the 20SSC-H (including the PLC).)

- 1) The 20SSC-H transfers the data stored in the flash memory to the buffer memory.
- 2) The 20SSC-H transfers the data (servo parameters) stored in the flash memory to the servo amplifier.

- How to transfer the servo parameters set in the sequence program to the servo amplifier

(The 20SSC-H Ver. 1.10 or later supports this method.)

→ For the parameter setting method, refer to Section 7.1

Procedure (Transfer sequence: a) and b) in the above figure)

Stores, in the flash memory, the servo series [BFM #15000 (X-axis) and #15200 (Y-axis)] set to any value other than the connected servo amplifier series and the servo parameter transfer mode (b15) set to ON in the operation parameter 2 [BFM #14002 (X-axis) and #14202 (Y-axis)].

After turning the power ON or executing the system reset command*1, the following events occur: (Turn ON the power to the amplifier first, and then to the 20SSC-H (including the PLC).)

- a) The 20SSC-H transfers the data stored in the flash memory to the buffer memory.
Next, use the sequence program sets the servo amplifier series connected to the servo series [BFM #15000 (X-axis) and #15200 (Y-axis)].
- b) The 20SSC-H transfers the data (servo parameters) stored in the buffer memory to the servo amplifier.

*1. Only supported by 20SSC-H Ver. 1.10 or later. For details on system reset, refer to the following:

→ Refer to Subsection 7.9.12

Note

To transfer the following parameters from the buffer memory (BFM) to the servo amplifier, turn the servo parameter transfer command (b9) of operation command 2 [BFM #519 (X-axis) and #619 (Y-axis)] to ON.

→ **For the operation command, refer to Subsection 11.4.11**

→ **For the operation procedure, refer to Subsection 7.1.8**

- Auto tuning mode
- Auto tuning response
- Feed forward gain
- Ratio of load inertia moment to servo motor inertia moment
- Model control gain
- Position control gain
- Speed control gain
- Speed integral compensation
- Speed differential compensation

1

Introduction

2System
configuration**3**

Specifications

4

Installation

5

Wiring

6Memory Config.
and data
operation**7**Before starting
positioning
operation**8**

Manual control

9Positioning
Control**10**

Table Operation

7. Before Starting Positioning Operation

DESIGN PRECAUTIONS



WARNING

- Make sure to have the following safety circuits outside of the PLC to ensure safe system operation even during external power supply problems or PLC failure.
Otherwise, malfunctions may cause serious accidents.
 - 1) Most importantly, have the following: an emergency stop circuit, a protection circuit, an interlock circuit for opposite movements (such as normal vs. reverse rotation), and an interlock circuit (to prevent damage to the equipment at the upper and lower positioning limits).
 - 2) Note that when the PLC CPU detects an error, such as a watchdog timer error, during self-diagnosis, all outputs are turned off. Also, when an error that cannot be detected by the PLC CPU occurs in an input/output control block, output control may be disabled.
External circuits and mechanisms should be designed to ensure safe machinery operation in such a case.
 - 3) Note that when an error occurs in a relay, triac or transistor output device, the output could be held either on or off.
For output signals that may lead to serious accidents, external circuits and mechanisms should be designed to ensure safe machinery operation in such a case.
- At Forward/Reverse rotation limits, make sure to wire the contacts with NC, negative-logic. Wiring contacts with NO, positive-logic may cause serious accidents.

DESIGN PRECAUTIONS



CAUTION

- Make sure to observe the following precautions in order to prevent any damage to the machinery or accidents due to abnormal data written to the PLC under the influence of noise:
 - 1) Do not bundle the main circuit line together with or lay it close to the main circuit, high-voltage line or load line. Otherwise, noise disturbance and/or surge induction are likely to take place. As a guideline, lay the control line at least 100mm (3.94") or more away from the main circuit or high-voltage lines.
 - 2) Ground the shield wire or shield of the shielded cable at one point on the PLC. However, do not ground them at the same point as the high-voltage lines.
- Install module so that excessive force will not be applied to the built-in programming port, input connectors, power connectors or optical connectors. Failure to do so may result in wire damage/breakage or PLC failure.

7.1 Note on Setting Parameters

Set the positioning parameters and servo parameters according to the system.

Axis selection of servo amplifier

The 20SSC-H controls the X- and Y-axis based on the order (smaller numbers given higher priority) of the axis selection setting in the servo amplifier.

Therefore, set servo parameters corresponding to axis selection setting at servo amplifier.

If the axis selection setting at servo amplifiers are the same, external errors (error code: 4011) may occur in the 20SSC-H.

Setting example

Servo amplifier	Control axis of 20SSC-H	Servo amplifier side	
		Rotary axis setting switch	axis selection
MR-J3-□B, MR-J3-□BS, MR-J4-□B	X-axis	0	Axis No.1
	Y-axis	1	Axis No.2
MR-J3W-□B, MR-J4W2-□B	X-axis	0	Axis No.1 (A-axis)
	Y-axis		Axis No.2 (B-axis)

Caution on the use of the MR-J3W-□B

The 20SSC-H can connect and use the MR-J3W-□B within the functional range of the MR-J3-□B.

Therefore, set up servo parameters within the range of the servo parameters of the MR-J3-□B, and set them according to the following points carefully.

→ **For setting up servo parameters of the MR-J3W-□B, refer to the MR-J3W-□B Servo Amplifier Instruction Manual**

- a) Parameters shared between two axes
Shared servo parameters between two axes should have the same setup for both axes (X-axis, Y-axis) in servo parameters of the 20SSC-H.
If they are set up differently, the setting value of the last axis set up is set to both axes of the servo amplifier.
- b) Servo series setup of the 20SSC-H
The servo series of the 20SSC-H should set for both axes (X-axis, Y-axis) as "1: MR-J3-B."
- c) When using the MR-J3W-□B using single axis setup
Even if using the MR-J3W-□B using single axis setup, the servo series of the 20SSC-H should set for both axes as "1: MR-J3-B."
If not set in both axes, communication between the 20SSC-H and servo amplifier cannot be started.

Caution on the use of the MR-J3-□BS

The 20SSC-H does not support the fully closed loop system.

Therefore, set up servo parameters within the range of the semi closed loop system.

→ **For setting up servo parameters of the MR-J3-□BS, refer to the MR-J3-□B Safety Servo Amplifier Instruction Manual**

Caution on the use of the MR-J4-□B

The 20SSC-H can connect and use the MR-J4-□B within the functional range of the "J3 compatibility mode". Therefore, set up servo parameters within the range of the MR-J3-□B/BS, and set them according to the following points carefully.

→ **For setting up servo parameters of the MR-J4-□B, refer to the MR-J4-□B Servo Amplifier Instruction Manual**

- Servo series setup of the 20SSC-H
Set "1: MR-J3-B" when using functions corresponding to the MR-J3-□B.
Set "3: MR-J3-BS" when using functions corresponding to the MR-J3-□BS.

Caution on the use of the MR-J4W2-□B

The 20SSC-H can connect and use the MR-J4W2-□B within the functional range of the "J3 compatibility mode".

Therefore, set up servo parameters within the range of the servo parameters of the MR-J3-□B/BS, and set them according to the following points carefully.

→ **For setting up servo parameters of the MR-J4W2-□B, refer to the MR-J4W2-□B Servo Amplifier Instruction Manual**

- a) Parameters shared between two axes
Shared servo parameters between two axes should have the same setup for both axes (X-axis, Y-axis) in servo parameters of the 20SSC-H.
If they are set up differently, the setting value of the last axis set up is set to both axes of the servo amplifier.
- b) Servo series setup of the 20SSC-H
The servo series of the 20SSC-H should set for both axes (X-axis, Y-axis) as "3: MR-J3-BS."
- c) When using the MR-J4W2-□B using single axis setup
Turn on the disabling control axis switches (SW2-3) of the servo amplifier.

The following parameters must be set.

- 1) Servo series [Servo parameters (Basic setting)]
*This parameter must be set to transfer information between the 20SSC-H and servo amplifier.
Set the servo series of servo parameters according to the servo amplifier.*
→ **For servo series details, refer to Subsection 11.2.1**
- 2) Function selection C-4 [Servo parameters (Expansion setting)]
Immediately after power ON, this parameter needs to be set to operate in modes other than the JOG or manual pulse generator operation modes.
Set "1: Not needed to pass motor Z-phase after the power supply is switched on" (default setting) here.
In other setting cases, the servo motor should be rotated more than one revolution by the JOG or manual pulse generator immediately after power-ON.
→ **For details, refer to Subsection 8.1.2 to 8.1.5 and 11.2.3**
- 3) Zero return interlock setting [Positioning parameters (Operation parameter 2)]
Immediately after power ON, this parameter needs to be set to operate in modes other than the JOG, manual pulse generator or mechanical return operation modes.
Set "0: Disable" here.
In other setting cases, operate to be set to the zero return executed flag.
→ **For details, refer to Subsection 7.9.10 and 11.1.2**

7.1.1 Types of parameter setting method

Parameters of the 20SSC-H can be set using any one of the following methods.

Note

It is recommended to set positioning parameters, servo parameters and table information using FX Configurator-FP, and then save them in the flash memory.

If they are set using a sequence program, it is necessary to create a complicated sequence program and use many devices. As a result, the scan time will increase.

1. Using FX Configurator-FP

- 1) Setting the parameters [Recommended]
Set positioning parameters and servo parameters of the 20SSC-H using FX Configurator-FP.
(Set them from the flash memory.)
→ Refer to the Subsection 7.1.2
- 2) Initializing the parameters
Initialize positioning parameters and servo parameters of the 20SSC-H using FX Configurator-FP.
→ Refer to the Subsection 7.1.3

2. Using a sequence program

- 1) Setting the parameters
 - a) Setting from the flash memory
Set positioning parameters and servo parameters from the flash memory at startup.
→ Refer to the Subsection 7.1.4
 - b) Setting the parameters from the buffer memory (Ver. 1.10 or later)
Set positioning parameters and servo parameters from the buffer memory.
→ Refer to the Subsection 7.1.5
- 2) Initializing the parameters
Initialize positioning parameters and servo parameters of the 20SSC-H using a sequence program.
→ Refer to the Subsection 7.1.6
- 3) Others
 - a) Updating the positioning parameters
Enable the positioning parameters changed using a sequence program.
→ Refer to the Subsection 7.1.7
 - b) Updating some servo parameters
Transfer the following servo parameters changed using a sequence program to the servo amplifier.
→ Refer to the Subsection 7.1.8

• Auto tuning mode	• Ratio of load inertia moment to servo motor inertia moment	• Speed control gain
• Auto tuning response	• Model control gain	• Speed integral compensation
• Feed forward gain	• Position control gain	• Speed differential compensation
 - c) Saving the positioning parameters, servo parameters and table information to the flash memory
Save positioning parameters, servo parameters and table information stored in the buffer memory to the flash memory using a sequence program.
→ Refer to the Subsection 7.1.9

7.1.2 Setting parameters [FX Configurator-FP] [Recommended]

This subsection explains how to set positioning parameters and servo parameters of the 20SSC-H using FX Configurator-FP.

The setting method is explained on the condition that a file is created in FX Configurator-FP.

→ For details on FX Configurator-FP operation procedures, refer to the FX Configurator-FP OPERATION MANUAL

1 Setting positioning parameters

Double-click [File name] → [Edit] → [Positioning parameters] in the file data list.

When the edit window for positioning parameters appears, set each parameter.

→ For the contents of setting of positioning parameters, refer to Section 11.1

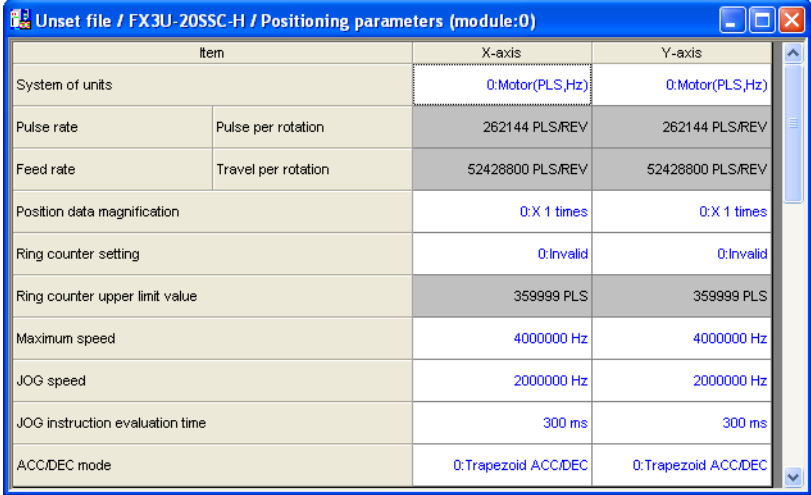

Item		X-axis	Y-axis
System of units		0:Motor(PLS,Hz)	0:Motor(PLS,Hz)
Pulse rate	Pulse per rotation	262144 PLS/REV	262144 PLS/REV
Feed rate	Travel per rotation	52428800 PLS/REV	52428800 PLS/REV
Position data magnification		0:X 1 times	0:X 1 times
Ring counter setting		0:Invalid	0:Invalid
Ring counter upper limit value		359999 PLS	359999 PLS
Maximum speed		4000000 Hz	4000000 Hz
JOG speed		2000000 Hz	2000000 Hz
JOG instruction evaluation time		300 ms	300 ms
ACC/DEC mode		0:Trapezoid ACC/DEC	0:Trapezoid ACC/DEC

2 Setting servo parameters

Double-click [File name] → [Edit] → [Servo parameters] in the file data list.

When the edit window for servo parameters appears, set each parameter.

Make sure to set the servo amplifier series in accordance with the used servo amplifier.

→ For details on servo parameters, refer to **Section 11.2 and the Servo Amplifier Instruction Manual (technical data)**

Kind		Item	X-axis	Y-axis	
Servo amplifier series	Servo amplifier series		0:Not used	0:Not used	
	Control mode	Control loop composition selection	0:standard control 350 maximum torque setting of HF-KP servo motor(Invalid)	0:standard control 350 maximum torque setting of HF-KP servo motor(Invalid)	
	Regenerative brake option	Selection of regenerative brake option	00:Regenerative brake option is not used	00:Regenerative brake option is not used	
	Absolute position detection system	Selection of absolute position detection system	0:Used in incremental system	0:Used in incremental system	
	Basic setting parameters	Function selection A-1	Servo forced stop selection	00:Forced stop 2 (EM2) The electromagnetic brake interlock(MBR) turns off after the forced stop deceleration. /0:Valid (Forced stop (EM1) is used.) /00:Forced stop 1 (EM1) The electromagnetic brake interlock(MBR) turns off without the forced stop deceleration.	00:Forced stop 2 (EM2) The electromagnetic brake interlock(MBR) turns off after the forced stop deceleration. /0:Valid (Forced stop (EM1) is used.) /00:Forced stop 1 (EM1) The electromagnetic brake interlock(MBR) turns off without the forced stop deceleration.
				Auto tuning	Gain adjustment mode setting
	Auto tuning response			12:37.0Hz	12:37.0Hz
	In-position range			100 pulse	100 pulse
	Rotation direction selection			0:Forward rotation (CCW) with the increase of the positioning address.	0:Forward rotation (CCW) with the increase of the positioning address.
	Encoder output pulse			4000 pulse/rev	4000 pulse/rev
Gain filter parameters	Adaptive tuning mode (Adaptive filter II)	Filter tuning mode selection	0:Filter OFF	0:Filter OFF	
	Vibration suppression control filter tuning mode (Advanced vibration suppression control)	Vibration suppression control tuning mode	0:Vibration suppression control OFF	0:Vibration suppression control OFF	

3 Setting the connection destination

Select [Online] → [Connection setup].

When the connection setup dialog box appears, set each item, and then click the [OK] button.

Connection setup dialog box showing the following settings:

- PC side: RS-232C (FX-USB-AW/FX3U-USB-BD Included)
- USB(GOT Transparent)
- Module: Module No.
- COM port:
- Transmission speed:
- Time check: Sec

4 Connecting a personal computer to the PLC main unit

→ For the connection route, refer to the FX Configurator-FP OPERATION MANUAL

5 Transferring positioning parameters and servo parameters to the 20SSC-H (Writing them to the flash memory)

Select [Online] → [Write to module].

When the Write to module dialog box appears, select data to be written, and then click the [OK] button.

Make sure to check the check box "Flash ROM write" here because parameters should be written also to the flash memory in the 20SSC-H.

Saving parameters to the flash memory

Make sure to save the parameters to the flash memory.

When the power of the 20SSC-H is turned OFF once and then turned ON again, the following data stored in the flash memory is transferred to the buffer memory.

		BFM number
Positioning parameters	X-axis	BFM #14000 to #14199
	Y-axis	BFM #14200 to #14399
Servo parameters	X-axis	BFM #15000 to #15199
	Y-axis	BFM #15200 to #15399
Table information	X-axis	BFM #1000 to #3999
	Y-axis	BFM #4000 to #6999
	XY-axis	BFM #7000 to #12999

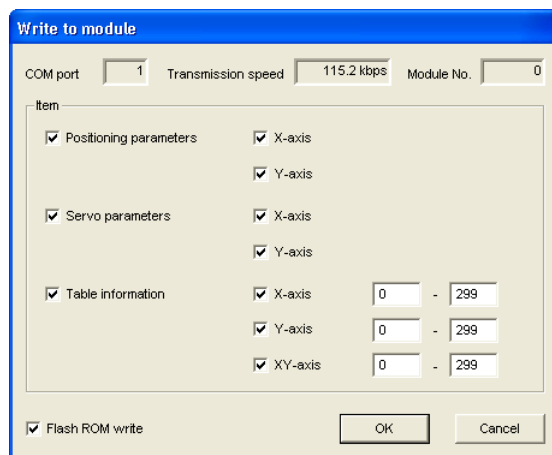

6 Transferring servo parameters to the servo amplifier

- 1) Turn OFF the power of the servo amplifier and PLC (including the 20SSC-H).
- 2) Turn ON the power of the servo amplifier.
- 3) Turn ON the power of the PLC (including the 20SSC-H).

Transfer method by system reset (20SSC-H Ver. 1.10 or later)

By system reset performed for the 20SSC-H Ver. 1.10 or later from FX Configurator-PP (Ver. 1.10 or later), servo parameters will be transferred to the servo amplifier.

- 1) Select [Online] → [System reset].
- 2) When the following message appears, click the [Yes] button to perform system reset. Click the [No] button to cancel the system reset operation.

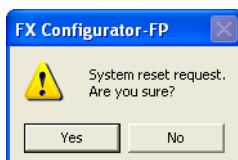

7.1.3 Initializing parameters [FX Configurator-FP]

This subsection explains how to initialize positioning parameters and servo parameters in the 20SSC-H using FX Configurator-FP.

The initialization method is explained on the condition that a file is created in FX Configurator-FP.

→ For details of FX Configurator-FP operation procedures, refer to the FX Configurator-FP OPERATION MANUAL

1 Setting the connection destination

Select [Online] → [Connection setup].

When the Connection setup dialog box appears, set each item, and then click the [OK] button.

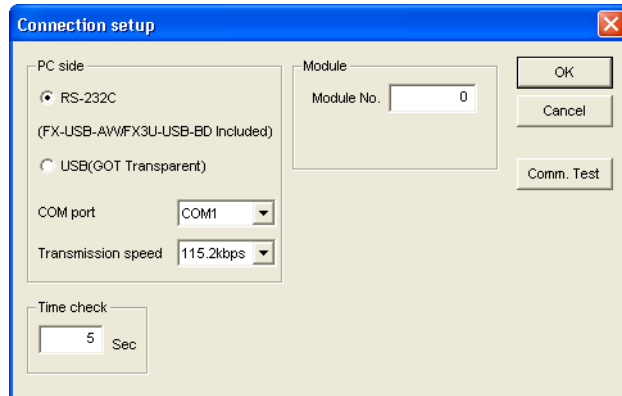

2 Connecting a personal computer to the PLC main unit

→ For the connection route, refer to the FX Configurator-FP OPERATION MANUAL

3 Initializing the positioning parameters and servo parameters stored in the buffer memory of the 20SSC-H

Select [Online] → [Initialize module].

When the initialize module dialog box appears, select data to be initialized, and then click the [OK] button.

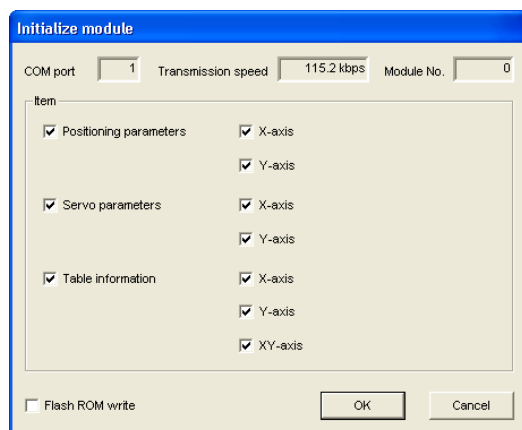

Caution

The X-axis and the Y-axis cannot be initialized if either the X-axis or the Y-axis is in a status disabling initialization (i.e. either axis is executing a positioning operation).

Make sure to wait until both the X-axis and the Y-axis are in a status enabling initialization, and then initialize parameters.

4 Setting positioning parameters and servo parameters to be changed from the default value

For the setting method, refer to the following.

→ **Refer to the Subsection 7.1.2**

7.1.4 Setting parameters from flash memory [Sequence program]

This subsection explains how to set positioning parameters and servo parameters from the flash memory at startup.

Because the parameter setting program is not required for the operation program, create it as a subroutine sequence as in the program example, create and execute it separately from the operation program.

→ For direct specification of the buffer memory using the FROM/TO instruction and applied instructions, refer to Section 12.1 and the PROGRAMMING MANUAL

Caution for using a 20SSC-H earlier than Ver. 1.10

Use FX Configurator-FP when changing servo parameters.

When changing servo parameters using a sequence program, change servo parameters stored in the buffer memory in the following status, save servo parameters to the flash memory, and then turn OFF and ON again the power of the servo amplifier and PLC (including the 20SSC-H).

- Status in which the power of the servo amplifier is OFF
- Status in which the servo amplifier is not connected to the 20SSC-H
Before turning ON the power of the PLC (including the 20SSC-H) again, connect the servo amplifier to the 20SSC-H.
- Status in which each flag of servo status 2 is as follows
Do not change servo parameters in the servo amplifier when changing servo parameters in the 20SSC-H. If servo parameters are changed in the servo amplifier, update of servo parameters is automatically started.

		BFM Number		State	Description
		X-axis	Y-axis		
Servo status 2	Parameter update completed flag	BFM #72 b0	BFM #172 b0	ON	<ul style="list-style-type: none"> • This bit is set when an automatic update of servo parameters is completed. • Cleared when a servo parameter save command or servo parameter initialization command is finished.
	Parameter updating flag	BFM #72 b1	BFM #172 b1	OFF	This bit is ON while servo parameters are being updated.
	Parameter update request flag	BFM #72 b2	BFM #172 b2	OFF	This bit turns ON when the servo amplifier sends servo parameter update request

Note

When using this setting method, make sure to set the following positioning parameters and servo parameters stored in the flash memory as follows.

- Positioning parameters (Ver. 1.10 or later)
Set the servo parameter transfer mode as follows.
→ For the operation parameter 2, refer to Subsection 11.1.2

		BFM Number		Description
		X-axis	Y-axis	
Operation parameter 2	Servo parameter transfer mode	BFM #14002 b15	BFM #14202 b15	Set this bit to OFF using a sequence program. (Transfers data stored in the flash memory to the servo amplifier.)

- Servo parameters
Set the servo series as follows.

		BFM Number		Description
		X-axis	Y-axis	
Servo series		BFM #15000	BFM #15200	Set the servo amplifier series connected to the 20SSC-H using a sequence program. 1: MR-J3-B ^{*1} 3: MR-J3-BS ^{*2}

*1. When connecting the MR-J3W-□B, set "1: MR-J3-B" as the servo series.

*2. The MR-J3-BS can be set for 20SSC-H blocks Ver.1.40 or later.
When connecting the MR-J4W2-□B, set "3: MR-J3-BS" as the servo series.

- 1) Finish positioning operation.
Make sure to change positioning parameters and servo parameters while positioning operation is stopped.
- 2) Stop automatic update of servo parameters (only Ver. 1.10 or later).
Set to ON from OFF the servo parameter update stop command in operation command 2.
→ For operation command 2, refer to Subsection 11.4.11

		BFM Number		Description
		X-axis	Y-axis	
Operation command 2	Servo parameter update stop	BFM #519 b11	BFM #619 b11	Set this bit to ON from OFF using a sequence program.
Servo status 2	Parameter update completed flag	BFM #72 b0	BFM #172 b0	<ul style="list-style-type: none"> • This bit is set when an automatic update of servo parameters is completed. • Cleared when a servo parameter save command or servo parameter initialization command is finished.
	Parameter updating flag	BFM #72 b1	BFM #172 b1	This bit is ON while servo parameters are being updated.
	Parameter update request flag	BFM #72 b2	BFM #172 b2	This bit turns ON when the servo amplifier sends servo parameter update request

- 3) Set positioning parameters stored in the buffer memory.
Save the set value of positioning parameters by direct specification of the buffer memory using the FROM/TO instruction and applied instructions to the buffer memory.
→ For the contents of positioning parameters, refer to Section 11.1

	BFM Number	
	X-axis	Y-axis
Positioning parameters	BFM #14000 to #14199	BFM #14200 to #14399

Set the servo parameter transfer mode as follows (Ver. 1.10 or later only).

		BFM Number		Description
		X-axis	Y-axis	
Operation parameter 2	Servo parameter transfer mode	BFM #14002 b15	BFM #14202 b15	Set this bit to OFF using a sequence program (so that the contents of the flash memory will be transferred to the servo amplifier).

- 4) Set servo parameters stored in the buffer memory.
Save the set value of servo parameters by direct specification of the buffer memory using the FROM/TO instruction and applied instructions to the buffer memory.
→ For the contents of servo parameters, refer to Section 11.2

		BFM Number		Description
		X-axis	Y-axis	
Servo parameter (Servo series)		BFM #15000	BFM #15200	Set the servo amplifier series connected to the 20SSC-H using a sequence program. 1: MR-J3-B ^{*1} 3: MR-J3-BS ^{*2}
Servo parameters (Except servo series)		BFM #15001 to #15199	BFM #15201 to #15399	Set them in accordance with the system.

- *1. When connecting the MR-J3W-□B, set "1: MR-J3-B" as the servo series.
- *2. The MR-J3-BS can be set for 20SSC-H blocks Ver.1.40 or later.
When connecting the MR-J4W2-□B, set "3: MR-J3-BS" as the servo series.

- 5) Enable (make valid) the control commands.
→ For the control command enable/disable, refer to Subsection 11.4.14

		BFM Number		Description
		X-axis	Y-axis	
Control command enable/disable		BFM #522		Write K5220 using a sequence program.

- 6) Set to ON from OFF the positioning parameter save command and servo parameter save command. When saving of parameters is completed, the saving to flash memory flag turns OFF from ON.

→ For control commands, refer to Subsection 11.4.15

		BFM Number		Description
		X-axis	Y-axis	
Control command	Positioning parameters save command	BFM #523 b0	BFM #523 b1	Set this bit to ON from OFF using a sequence program.
	Servo parameters save command	BFM #523 b5	BFM #523 b6	Set this bit to ON from OFF using a sequence program.
Status information	Saving to flash memory	BFM #28 b11		<ul style="list-style-type: none"> This bit is ON while saving buffer memory data into the flash memory. When finished storing the data, the bit is cleared.

- 7) Perform either of the following operations:
Transfer positioning parameters and servo parameters stored in the flash memory to the buffer memory. After that, transfer servo parameters to the servo amplifier.

- Performing system reset for the 20SSC-H

- a) Write the model code (K5220) to the control command enable/disable.

	BFM Number		Description
	X-axis	Y-axis	
Control command enable/disable	BFM #522		Write K5220 using a sequence program.

- b) Set the system reset command to ON (and keep it ON for 100 ms or more), and then reset it to OFF.
→ For the operation command 2, refer to the Subsection 11.4.11

		BFM Number		Description
		X-axis	Y-axis	
Operation command 2	System reset command	BFM #519 b1		Set this bit to ON (and keep it ON for 100 ms or more), and then reset it to OFF using a sequence program.

- Turning OFF the power of the servo amplifier and PLC (including the 20SSC-H), and then turning it ON again
- Turn OFF the power of the servo amplifier and PLC (including the 20SSC-H).
 - Turn ON the power of the servo amplifier.
 - Turn ON the power of the PLC (including the 20SSC-H).

Program example

This program example sets some positioning parameters and servo parameters for the X-axis and Y-axis in unit No. 1 as shown in the table below.

The set positioning parameters and servo parameters are saved in the flash memory, and then servo parameters are transferred to the servo amplifier. (Other parameters remain in the default value.)

Item	BFM Number		Description	
	X-axis	Y-axis		
Positioning parameters	Operation parameter 2	BFM #14002	BFM #14202	Set "H0007." b0: ON (Enables the servo end check function.) b1: ON (Enables the servo ready check function.) b2: ON (Enables the zero return interlock function.) b3: OFF ^{*1} (Disable the ring operation.) b4: OFF ^{*2} (Sets the sudden stop selection (STOP command) to the Normal deceleration stop.) b5: OFF ^{*2} (Sets the sudden stop selection (software limit) to the Normal deceleration stop.) b6: OFF ^{*2} (Sets the sudden stop selection (PLC limit) to the Normal deceleration stop.) b7: OFF ^{*2} (Sets the sudden stop selection (servo amplifier limit) to the Normal deceleration stop.) b8: OFF ^{*3} (Sets the status at startup of the servo amplifier to "servo ON".) b9 to b13: OFF (Not available.) b14: OFF ^{*2} (Sets the interpolation gear ratio selection to the X-axis.) b15: OFF ^{*1} (Sets the servo parameter transfer mode to "Transfer flash memory to servo amplifier.")
Servo parameters	Servo series	BFM #15000	BFM #15200	1: MR-J3-B
	Absolute position detection system	BFM #15003	BFM #15203	H0001 (Used in the absolute position detection system)
	Function selection C-4	BFM #15080	BFM #15280	1: Not need to pass motor Z-phase after power on

- *1. The setting is not required in a 20SSC-H whose version is earlier than Ver. 1.10 because such 20SSC-H does not support the corresponding function.
- *2. The setting is not required in a 20SSC-H whose version is earlier than Ver. 1.20 because such 20SSC-H does not support the corresponding function.
- *3. The setting is not required in a 20SSC-H whose version is earlier than Ver. 1.30 because such 20SSC-H does not support the corresponding function.

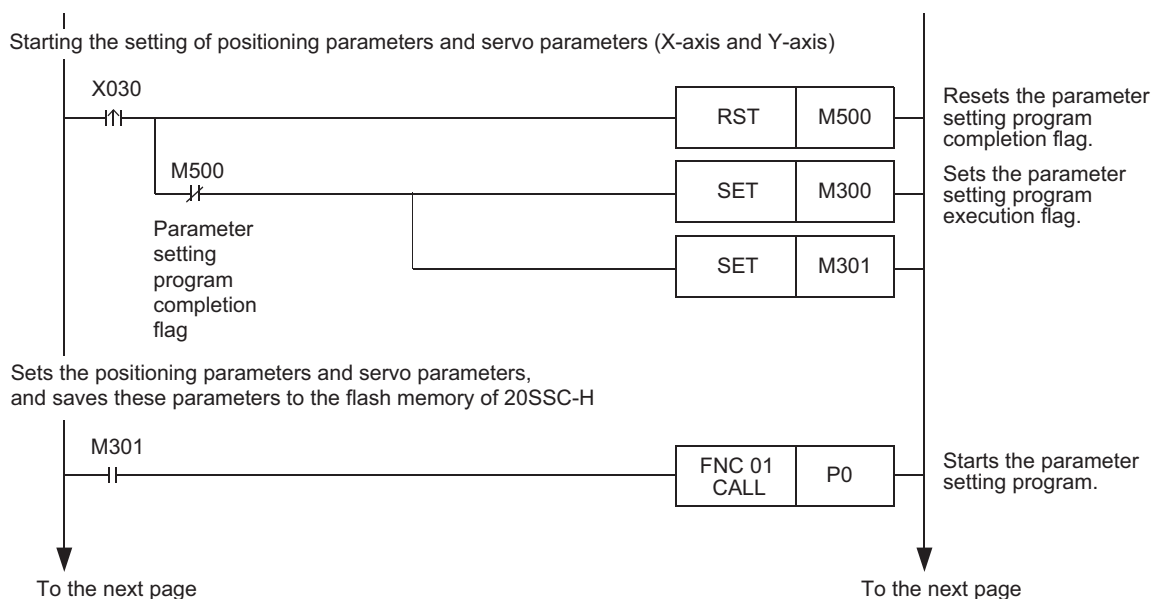

From the previous page

Executes system reset. [Ver. 1.10 or later]
 The power of the 20SSC-H is turned OFF once and then turned ON again when the version is earlier than Ver. 1.10.
 When turning ON power again, this ladder block is unnecessary.

[Power OFF procedure]

- 1) Check that M500 is ON by using device monitor.
- 2) Turn OFF the power.
- 3) Turn ON the power of the servo amplifier.
- 4) Turn ON the power of the PLC (including the 20SSC-H).

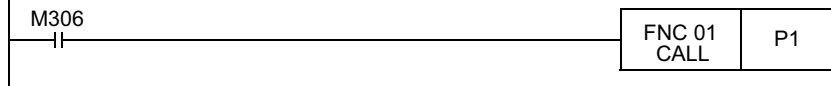

Starts the system reset program.

The reboot of 20SSC-H needs 10ms or more after system reset.
 When re-turning ON power, this ladder block is unnecessary.

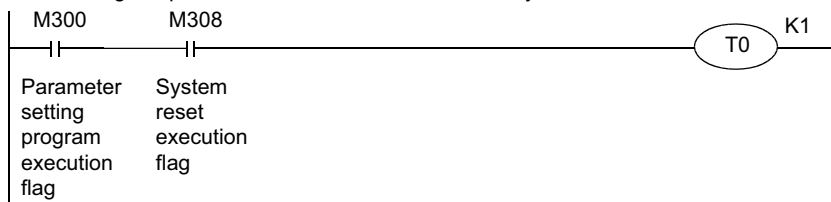

Parameter setting program execution flag	System reset execution flag
--	-----------------------------

When turning ON power again, change the contact of T0 to M306.
 And change "RST M308" to "RST M306."

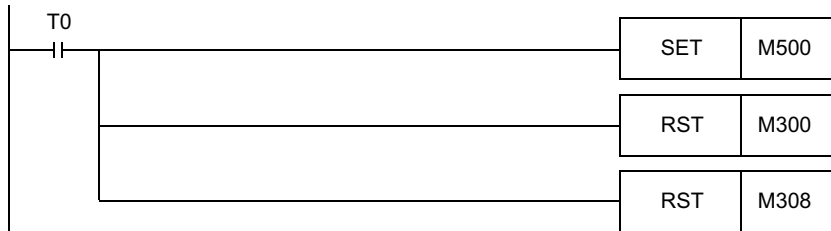

Set the parameter setting program completion flag.
 Resets the parameter setting program execution flag.
 Resets the system reset execution flag.



Parameter setting program completion flag	Parameter setting program execution flag
---	--

Jump to an END instruction.

Create the positioning operation program.
 A positioning operation program and a parameter setting program should provide an interlock in the program not to execute simultaneously.
 In this program example, while the parameter setting program is executing, M300 is ON.

To the next page

To the next page

- 1 Introduction
- 2 System configuration
- 3 Specifications
- 4 Installation
- 5 Wiring
- 6 Memory Config. and data operation
- 7 Before starting positioning operation
- 8 Manual control
- 9 Positioning Control
- 10 Table Operation

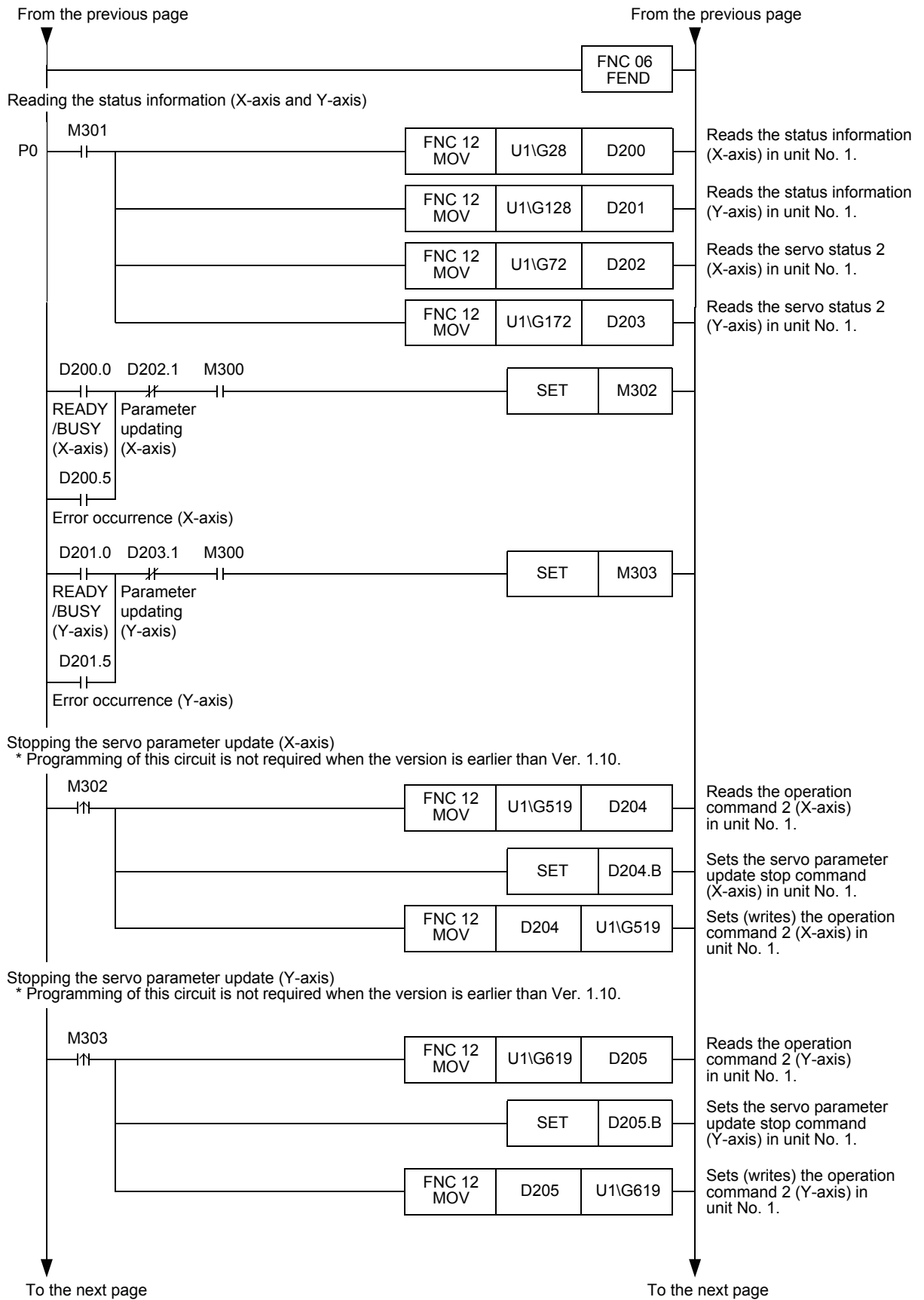

From the previous page

From the previous page

Initializing the positioning parameters and servo parameters in the buffer memory (X-axis and Y-axis)
 Initialization is not required in the following cases.

In these cases, having two MOV instructions in this circuit block is unnecessary. And change the contact of T1 to M304.

- When all positioning parameters and servo parameters will be set. (X-axis and Y-axis)
- When each of positioning parameters and servo parameters is at the initial value

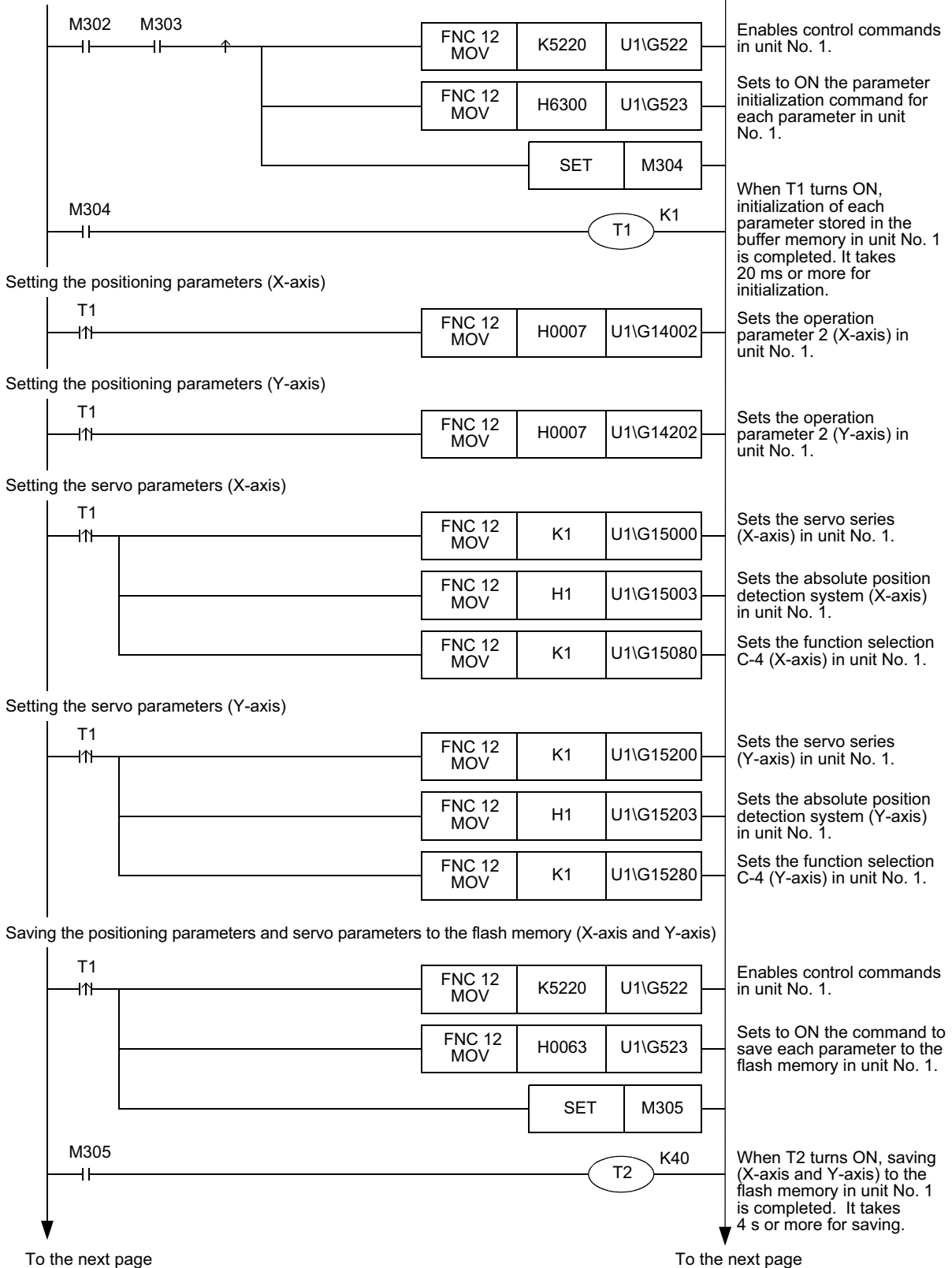

To the next page

To the next page

1	Introduction
2	System configuration
3	Specifications
4	Installation
5	Wiring
6	Memory Config. and data operation
7	Before starting positioning operation
8	Manual control
9	Positioning Control
10	Table Operation

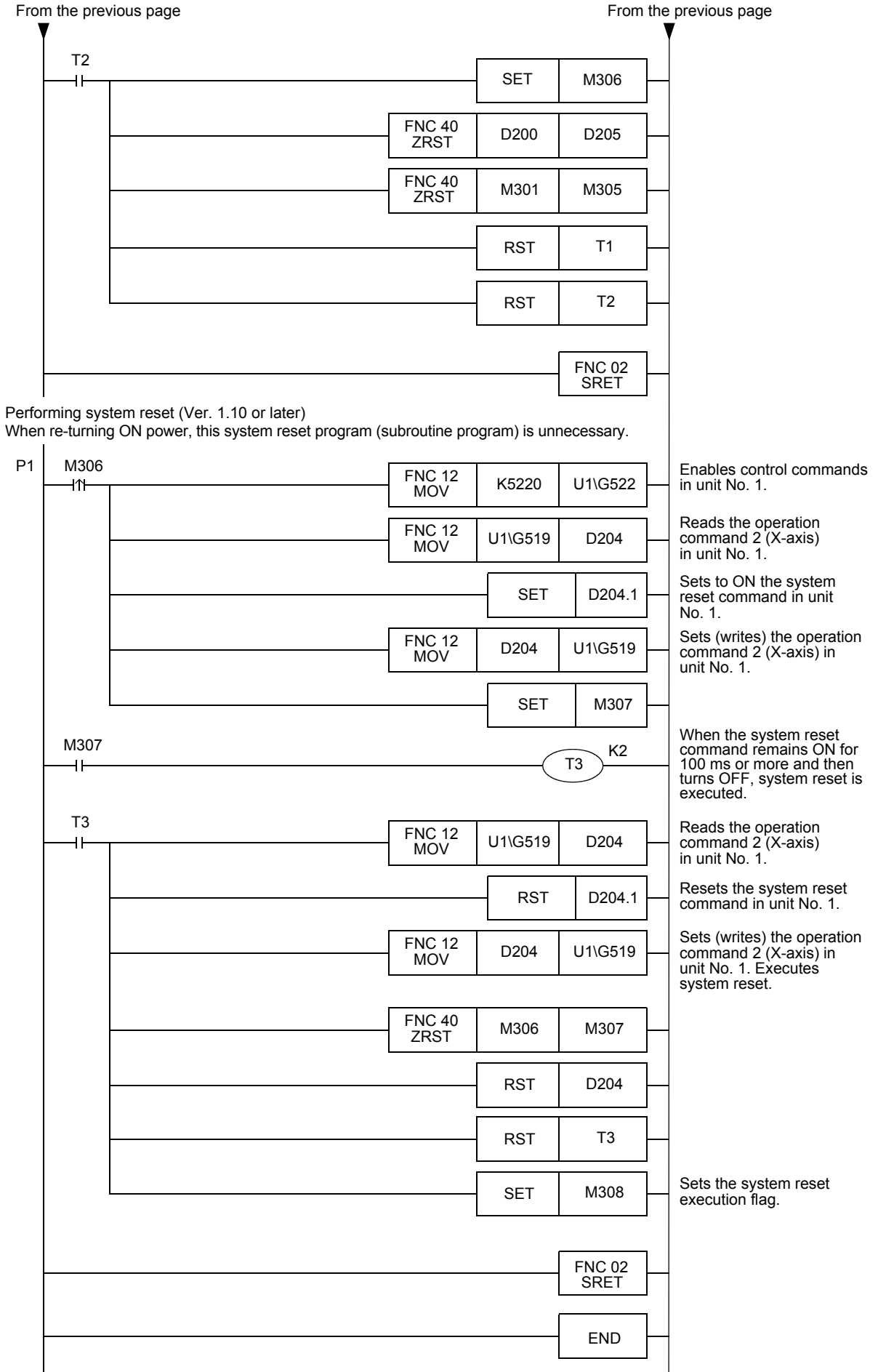

7.1.5 Setting parameters from the buffer memory [sequence program] (Ver. 1.10 or later)

This subsection explains how to set positioning parameters and servo parameters from the buffer memory.

→ **For direct specification of the buffer memory using the FROM/TO instruction and applied instructions. Refer to Section 12.1 and the PROGRAMMING MANUAL**

Note

When using this setting method, make sure to set the following servo series of servo parameters stored in the flash memory as follows.

In the setting program example mentioned later, when the servo series is set except for "K0", system reset is executed, after initializing the positioning parameters and servo parameters in the buffer memory and flash memory.

Moreover, parameters are set up after initializing them in the buffer memory.

Set the servo series as follows.

		BFM Number		Description
		X-axis	Y-axis	
Servo parameters	Servo series	BFM #15000	BFM #15200	Set "K0 (none)" (initial value) using a sequence program.

- Setting the positioning parameters stored in the buffer memory
Save the set value of servo positioning parameters by direct specification of the buffer memory using the FROM/TO instruction and applied instructions to the buffer memory.

→ **For the contents of setting of positioning parameters, refer to Section 11.1**

		BFM Number	
		X-axis	Y-axis
Positioning parameters		BFM #14000 to #14199	BFM #14200 to #14399

Set the servo parameter transfer mode as follows.

		BFM Number		Description
		X-axis	Y-axis	
Operation parameter 2	Servo parameter transfer mode	BFM #14002 b15	BFM #14202 b15	Set these bits to ON using a sequence program (so that the contents of the BFM will be transferred to the servo amplifier).

- Setting the following servo parameters except the servo series
Save the set value of servo parameters by direct specification of the buffer memory using the FROM/TO instruction and applied instructions to the buffer memory.

→ **For the contents of setting of servo parameters, refer to Section 11.2**

		BFM Number		Description
		X-axis	Y-axis	
Servo parameters (except servo series)		BFM #15001 to #15199	BFM #15201 to #15399	Set the parameters in accordance with the system.

- Setting to ON from OFF the positioning parameter enable command
When the positioning parameter enable command is set to ON from OFF while the target axis is not performing positioning operation, the system will use the changed positioning parameters from next positioning operation.

→ **For the operation command 2, refer to Subsection 11.4.11**

		BFM Number		Description
		X-axis	Y-axis	
Operation command 2	Positioning parameter enable command	BFM #519 b4	BFM #619 b4	Set these bits to ON from OFF using a sequence program.
Status information 2	Positioning parameter change completion flag (in Ver. 1.20 or later)	BFM #32 b0	BFM #132 b0	<ul style="list-style-type: none"> These bits turn ON when change of positioning parameters is completed. These bits turn OFF automatically when the positioning parameter enable command is set to OFF.

- 4) Set the servo series.
Transfer servo parameters to the servo amplifier.

	BFM Number		Description
	X-axis	Y-axis	
Servo series	BFM #15000	BFM #15200	Set the servo amplifier series connected to the 20SSC-H using a sequence program. 1: MR-J3-B ^{*1} 3: MR-J3-BS ^{*2}

- *1. When connecting the MR-J3W-□B, set "1: MR-J3-B" as the servo series.
*2. The MR-J3-BS can be set for 20SSC-H blocks Ver.1.40 or later.
When connecting the MR-J4W2-□B, set "3: MR-J3-BS" as the servo series.

Program example

In this program example, some positioning parameters and servo parameters for the X-axis and Y-axis in unit No. 1 are set as shown in the table below. After setting, the set servo parameters are transferred to the servo amplifier.

(Other parameters remain in the default value.)

Item	BFM Number		Description	
	X-axis	Y-axis		
Positioning parameters	Operation parameter 2	BFM #14002	BFM #14202	Set H8007. b0: ON (Enables the servo end check function.) b1: ON (Enables the servo ready check function.) b2: ON (Enables the zero return interlock function.) b3: OFF ^{*3} (Does not perform the ring counter setting of the current address.) b4: OFF ^{*4} (Sets the sudden stop selection (STOP command) to the Normal deceleration stop.) b5: OFF ^{*4} (Sets the sudden stop selection (software limit) to the Normal deceleration stop.) b6: OFF ^{*4} (Sets the sudden stop selection (PLC limit) to the Normal deceleration stop.) b7: OFF ^{*4} (Sets the sudden stop selection (servo amplifier limit) to the Normal deceleration stop.) b8: OFF ^{*5} (Sets the status at startup of the servo amplifier to "servo ON".) b9 to b13: OFF (These bits are not available.) b14: OFF ^{*4} (Sets the interpolation gear ratio selection to the X-axis.) b15: ON ^{*3} (Sets the servo parameter transfer mode to "Transfer flash memory to servo amplifier.")
	Maximum speed	BFM #14009, #14008	BFM #14209, #14208	Sets K2,000,000.
	JOG speed	BFM #14013, #14012	BFM #14213, #14212	Sets K1,000,000
	Zero return speed (high speed)	BFM #14025, #14024	BFM #14225, #14224	Sets K2,000,000
	Zero return speed (creep)	BFM #14027, #14026	BFM #14227, #14226	Sets K50,000
Servo parameter	Servo series	BFM #15000	BFM #15200	1: MR-J3-B
	Absolute position detection system	BFM #15003	BFM #15203	H0001 (Used in the absolute position detection system.)
	Selecting functions A-1	BFM #15004	BFM #15204	H0100: Disable [not use the forced stop (EMI)]
	Function selection C-4	BFM #15080	BFM #15280	1: Not need to pass motor Z-phase after power on

- *3. The setting is not required in a 20SSC-H whose version is earlier than Ver. 1.10 because such 20SSC-H does not support the corresponding function.
*4. The setting is not required in a 20SSC-H whose version is earlier than Ver. 1.20 because such 20SSC-H does not support the corresponding function.
*5. The setting is not required in a 20SSC-H whose version is earlier than Ver. 1.30 because such 20SSC-H does not support the corresponding function.

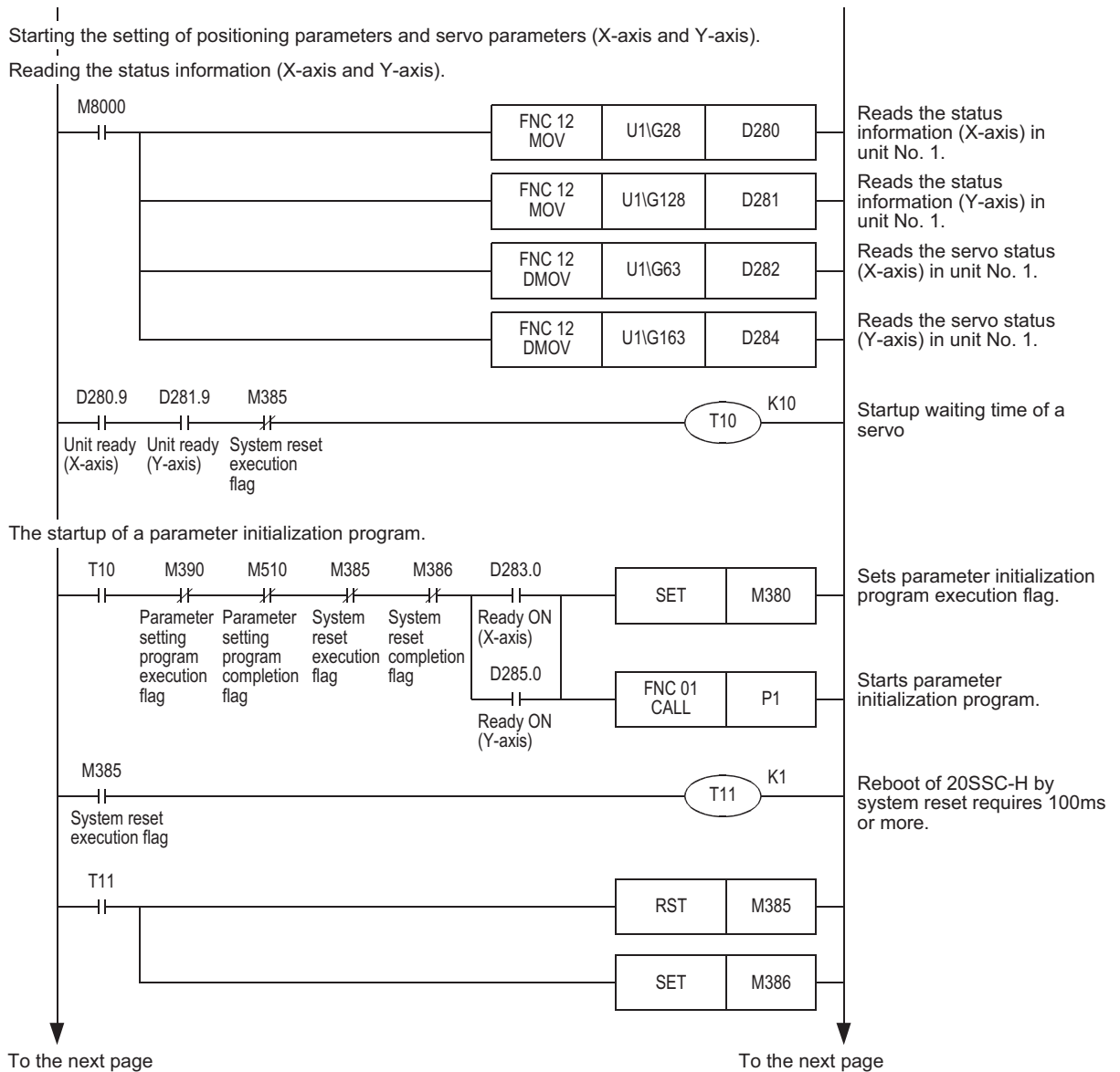

- 1 Introduction
- 2 System configuration
- 3 Specifications
- 4 Installation
- 5 Wiring
- 6 Memory Config. and data operation
- 7 Before starting positioning operation
- 8 Manual control
- 9 Positioning Control
- 10 Table Operation

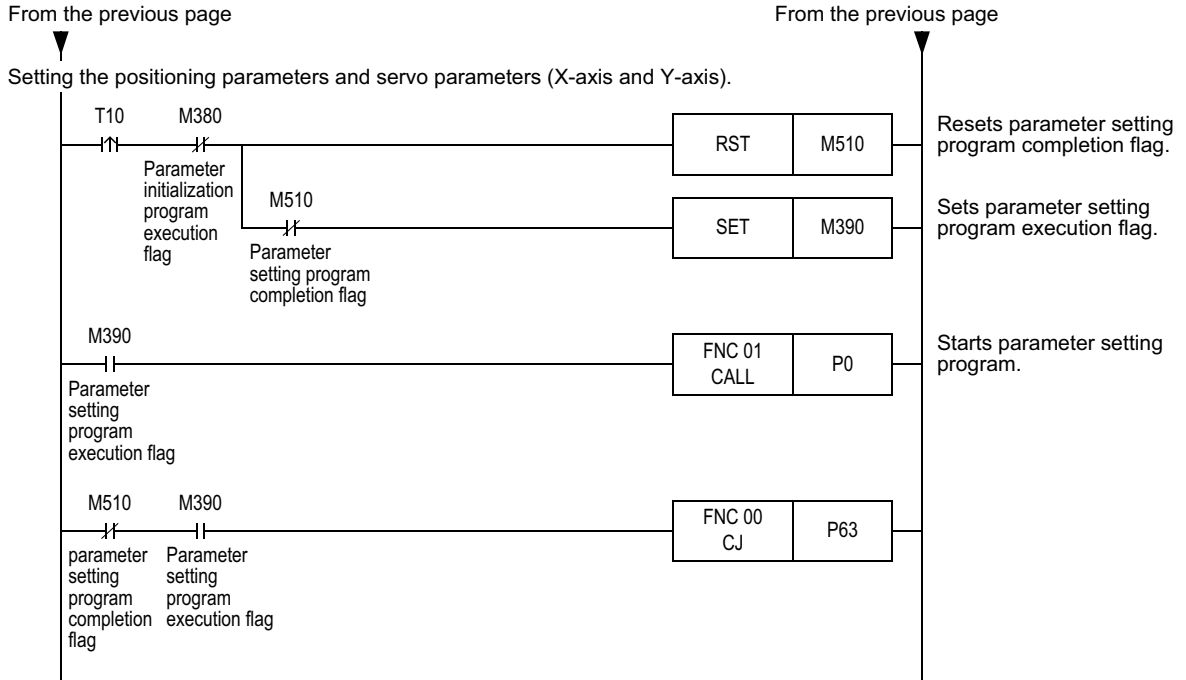

Create the positioning operation program.
 A positioning operation program and a parameter setting program should provide an interlock in the program not to execute simultaneously.
 In this program example, while the parameter setting program is executing, M380, M385 or M390 is ON.

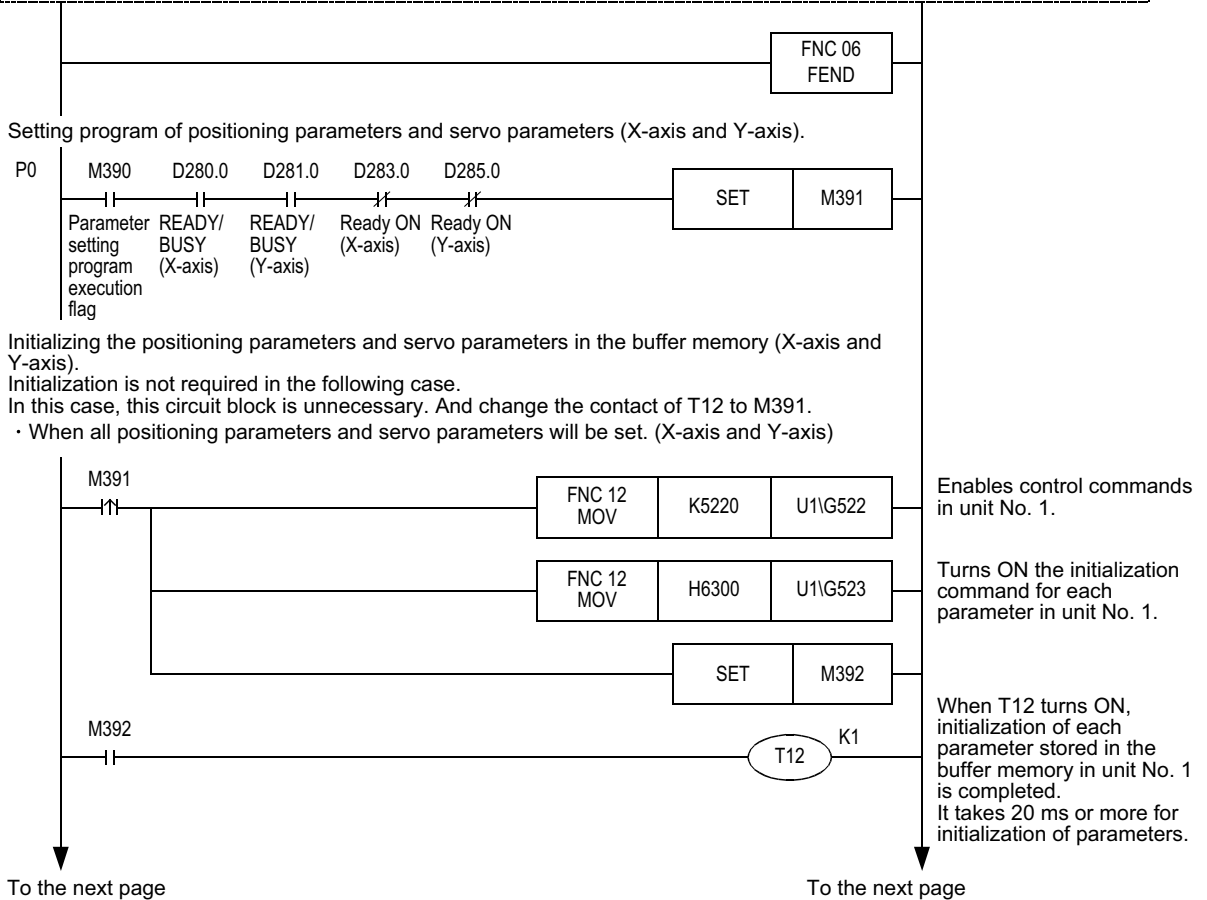

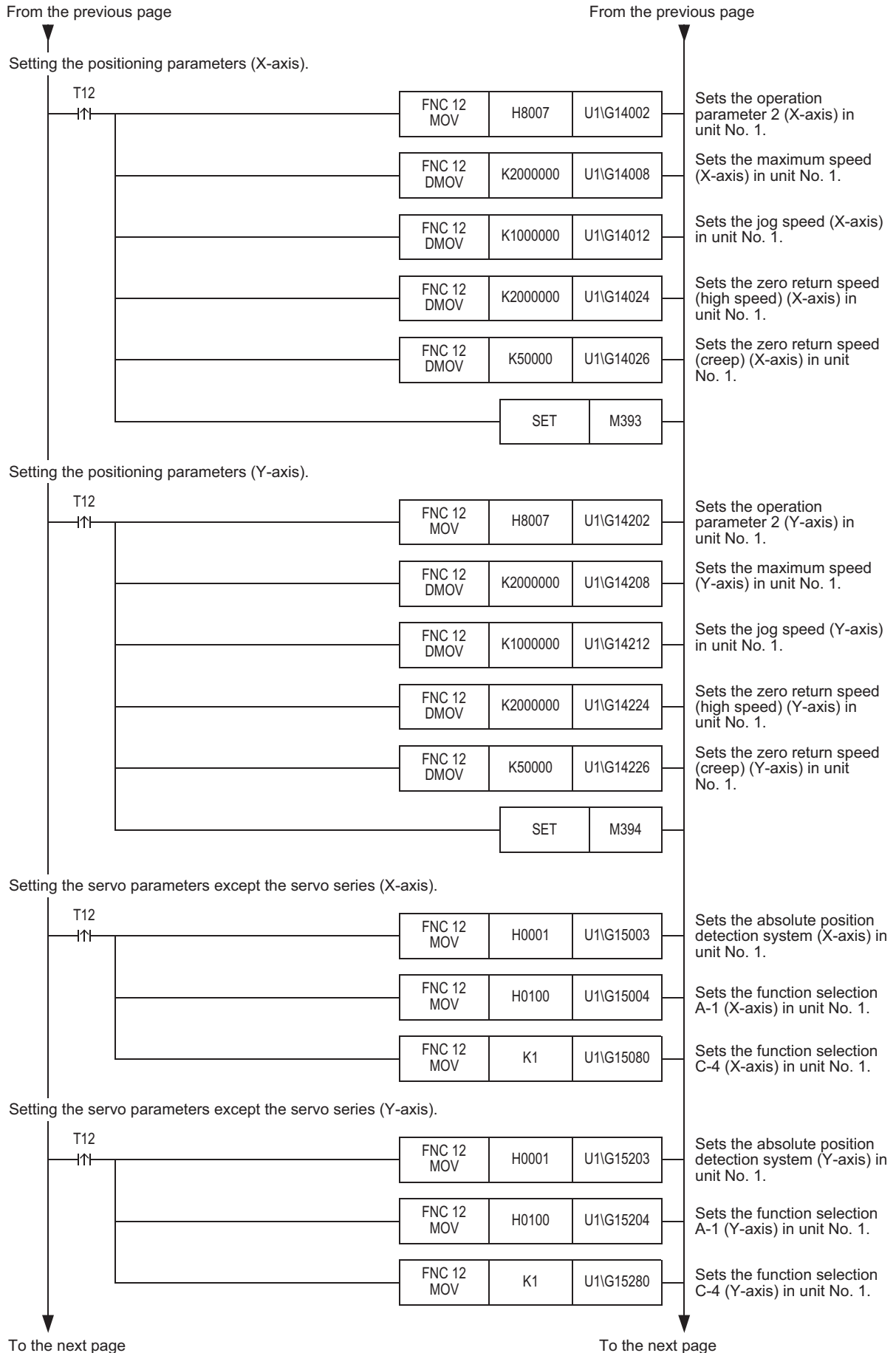

- 1 Introduction
- 2 System configuration
- 3 Specifications
- 4 Installation
- 5 Wiring
- 6 Memory Config[†] and data operation
- 7 Before starting positioning operation
- 8 Manual control
- 9 Positioning Control
- 10 Table Operation

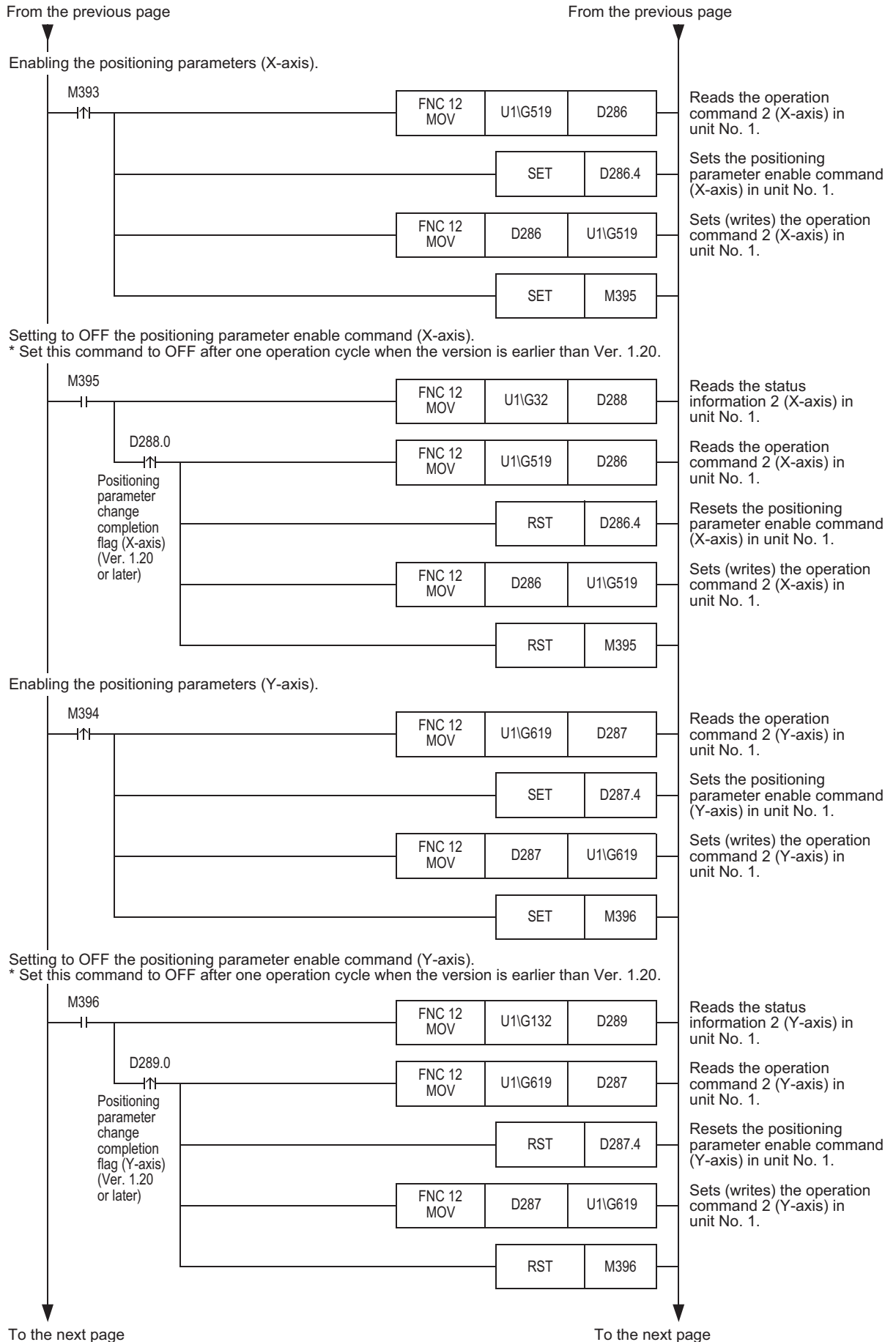

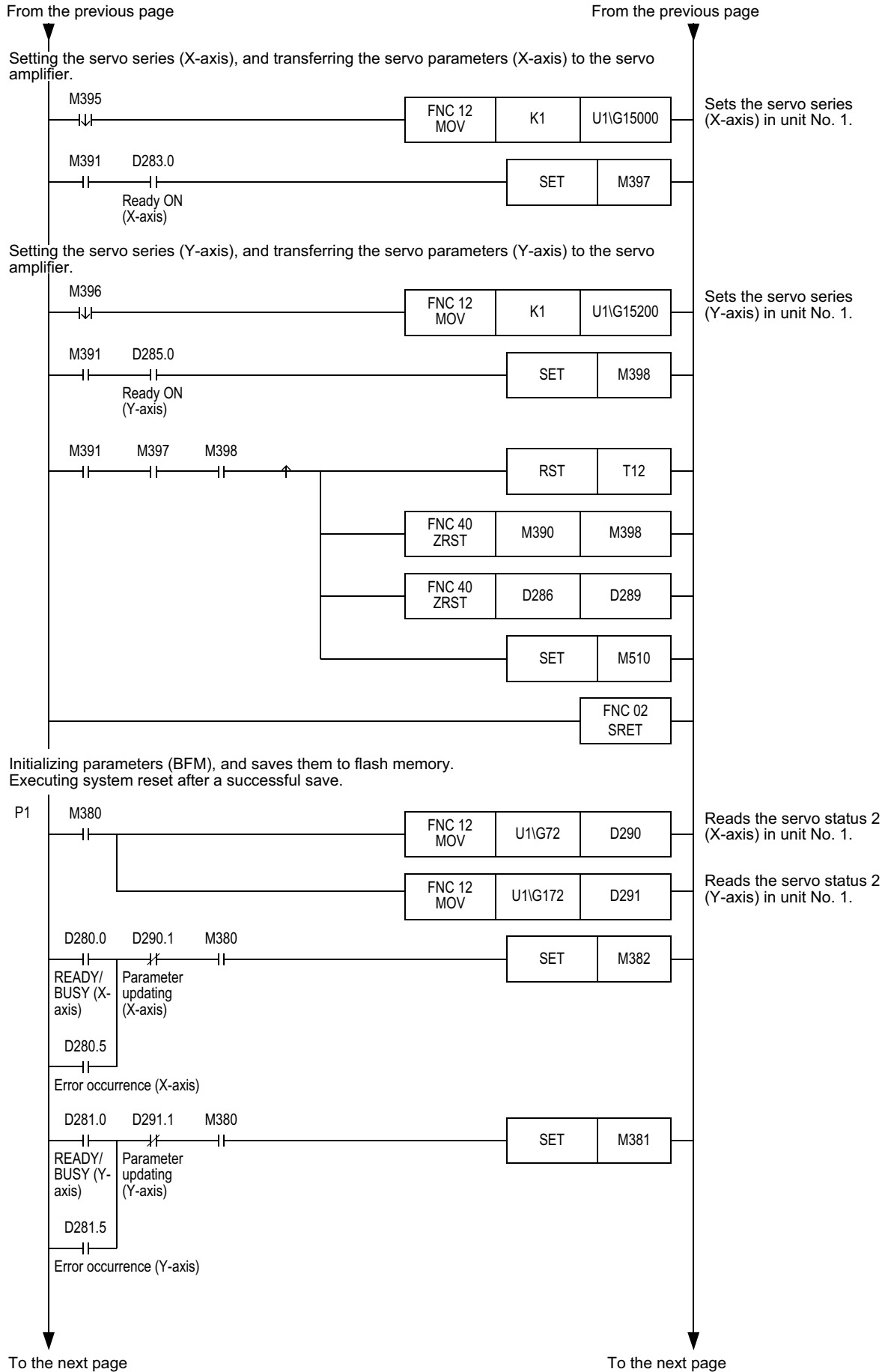

- 1 Introduction
- 2 System configuration
- 3 Specifications
- 4 Installation
- 5 Wiring
- 6 Memory Config. and data operation
- 7 Before starting positioning operation
- 8 Manual control
- 9 Positioning Control
- 10 Table Operation

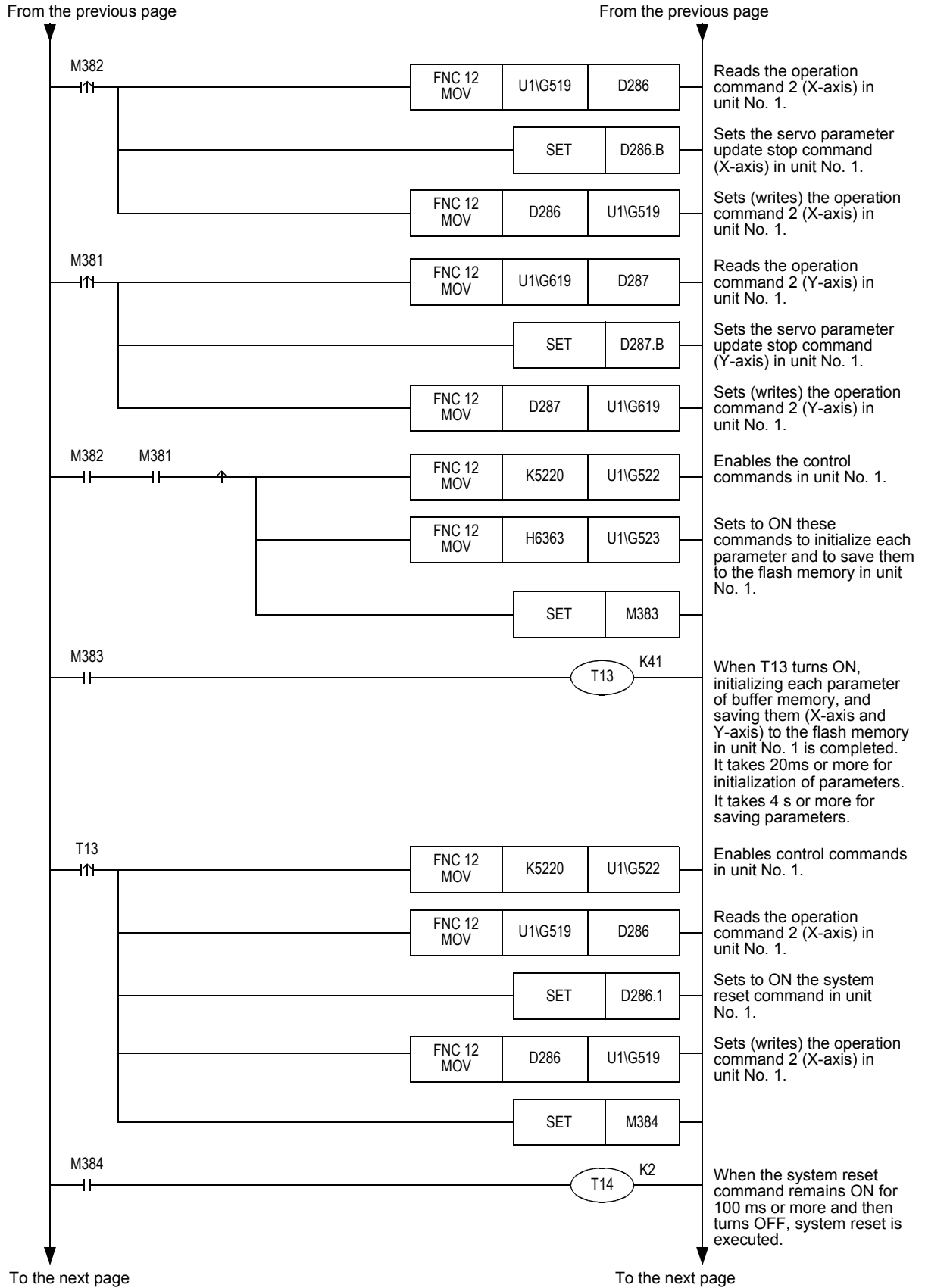

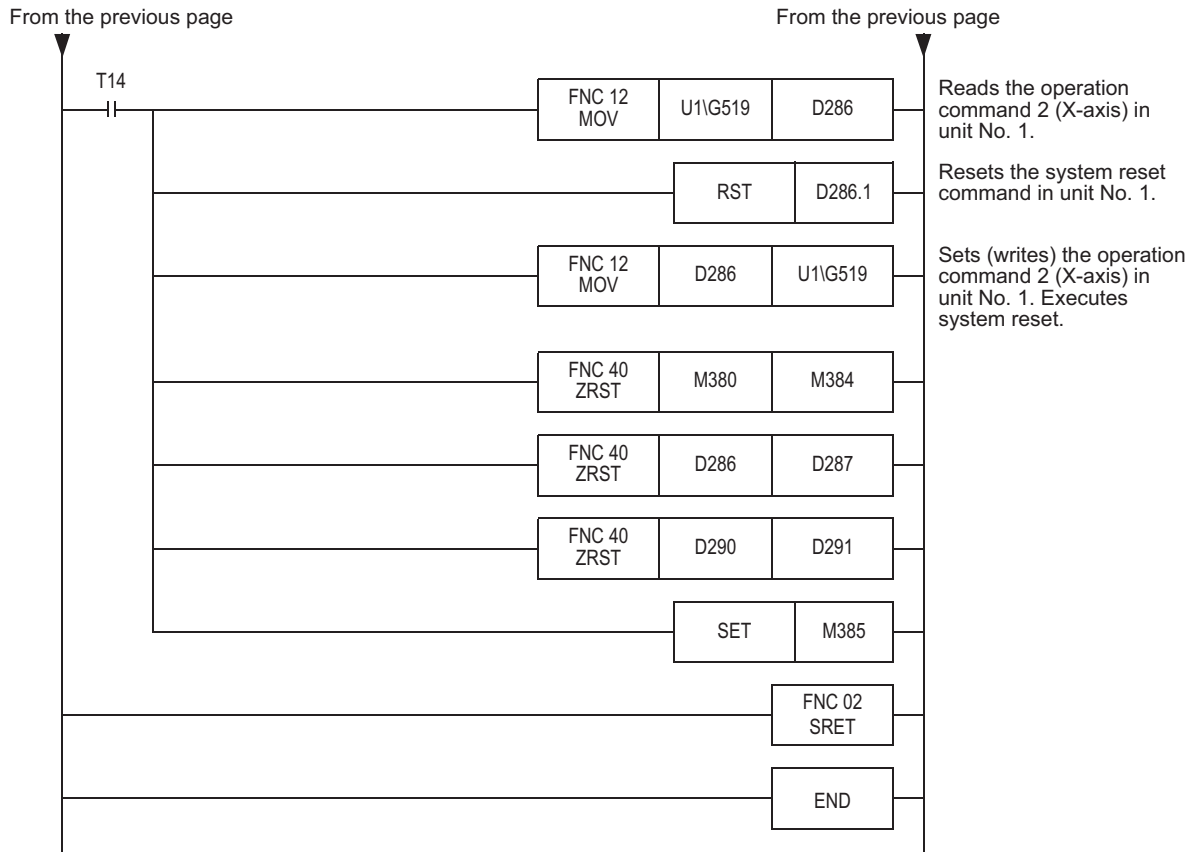

7.1.6 Initializing parameters [sequence program]

This subsection explains how to initialize positioning parameters and servo parameters of the 20SSC-H using a sequence program.

→ For direct specification of the buffer memory using the FROM/TO instruction and applied instructions, refer to Section 12.1 and the PROGRAMMING MANUAL

Caution when the version is earlier than Ver. 1.10

Use FX Configurator-FP when initializing servo parameters.

When initializing servo parameters using a sequence program, initialize servo parameters stored in the buffer memory in the following status, save servo parameters to the flash memory, and then turn OFF and ON again the power of the servo amplifier and PLC (including the 20SSC-H).

→ For the method to save parameters stored in the buffer memory to the flash memory, refer to Subsection 7.1.9

- Status in which the power of the servo amplifier is OFF
- Status in which the servo amplifier is not connected to the 20SSC-H
Before turning ON the power of the PLC (including the 20SSC-H) again, connect the servo amplifier to the 20SSC-H.

- 1) Enable (make valid) control commands.

→ For control command enable/disable, refer to Subsection 11.4.14

	BFM Number		Description
	X-axis	Y-axis	
Control command enable/disable	BFM #522		Write K5220 using a sequence program.

- 2) Set to ON from OFF the positioning parameter initialization command and servo parameter initialization command.

Initialize positioning parameters and servo parameters stored in the buffer memory.

(These initialization commands do not initialize the positioning parameters and servo parameters stored in the flash memory.)

→ For the Control command, refer to Subsection 11.4.15

		BFM Number		Description
		X-axis	Y-axis	
Control command	Positioning parameters initialization command	BFM #523 b8	BFM #523 b9	Set these bits to ON from OFF using a sequence program.
	Servo parameters initialization command	BFM #523 b13	BFM #523 b14	Set these bits to ON from OFF using a sequence program.

- 3) When initialization of positioning parameters and servo parameters stored in the buffer memory is completed, the "initializing buffer memory" flag changes from ON to OFF.

→ For the Status information, refer to Subsection 11.3.17

		BFM Number		Description
		X-axis	Y-axis	
Status information	Initializing buffer memory	BFM #28 b12		This bit remains ON while the data stored in the buffer memory is initialized. It turns OFF when initialization is finished.

- 4) Change positioning parameters and servo parameters stored in the buffer memory as necessary.

→ For the method to set the parameters using a sequence program, refer to Subsection 7.1.4 or 7.1.5

Program example

In this program, positioning parameters and servo parameters (X-axis and Y-axis) stored in the buffer memory are initialized.

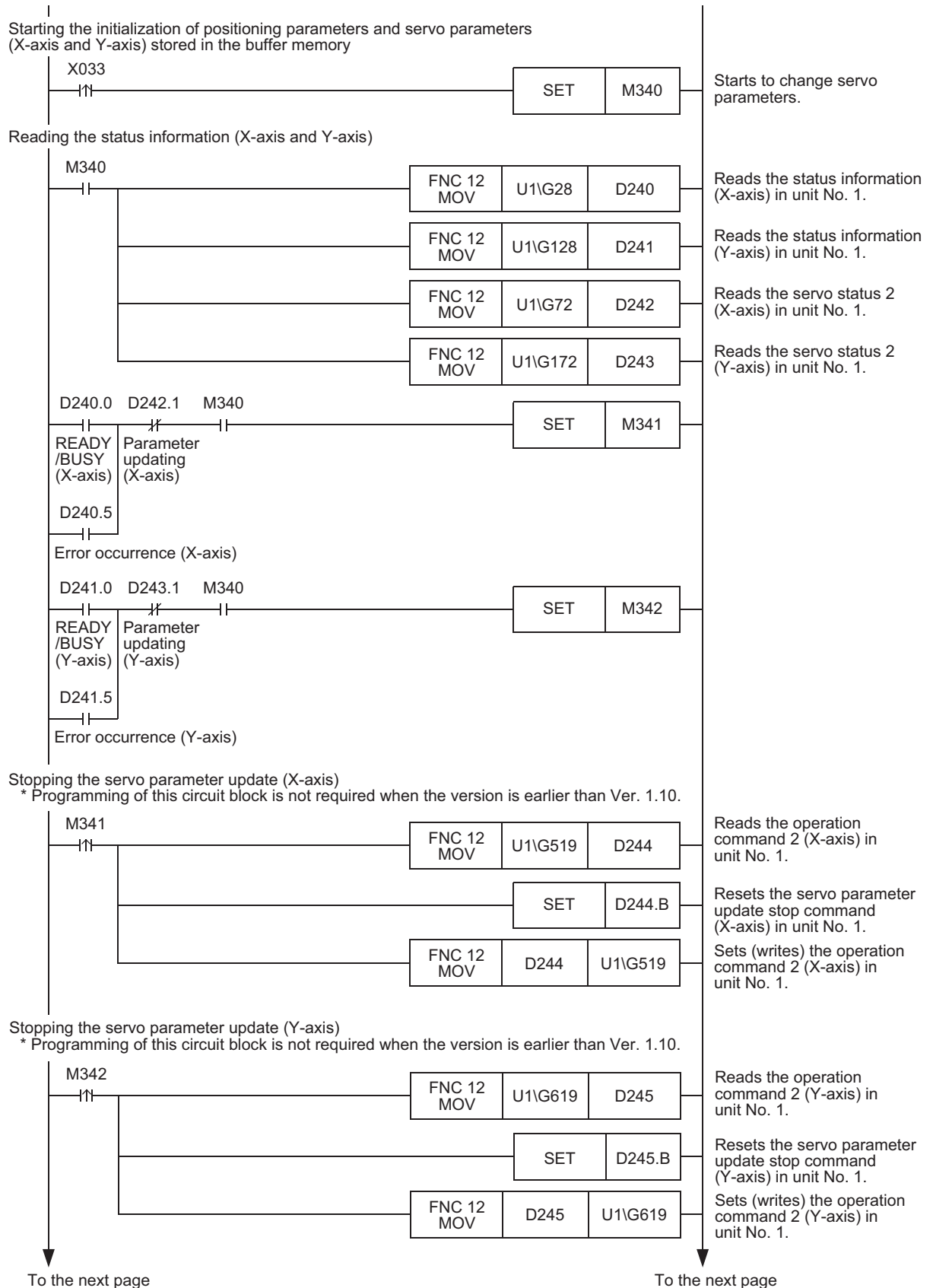

- 1 Introduction
- 2 System configuration
- 3 Specifications
- 4 Installation
- 5 Wiring
- 6 Memory Config. and data operation
- 7 Before starting positioning operation
- 8 Manual control
- 9 Positioning Control
- 10 Table Operation

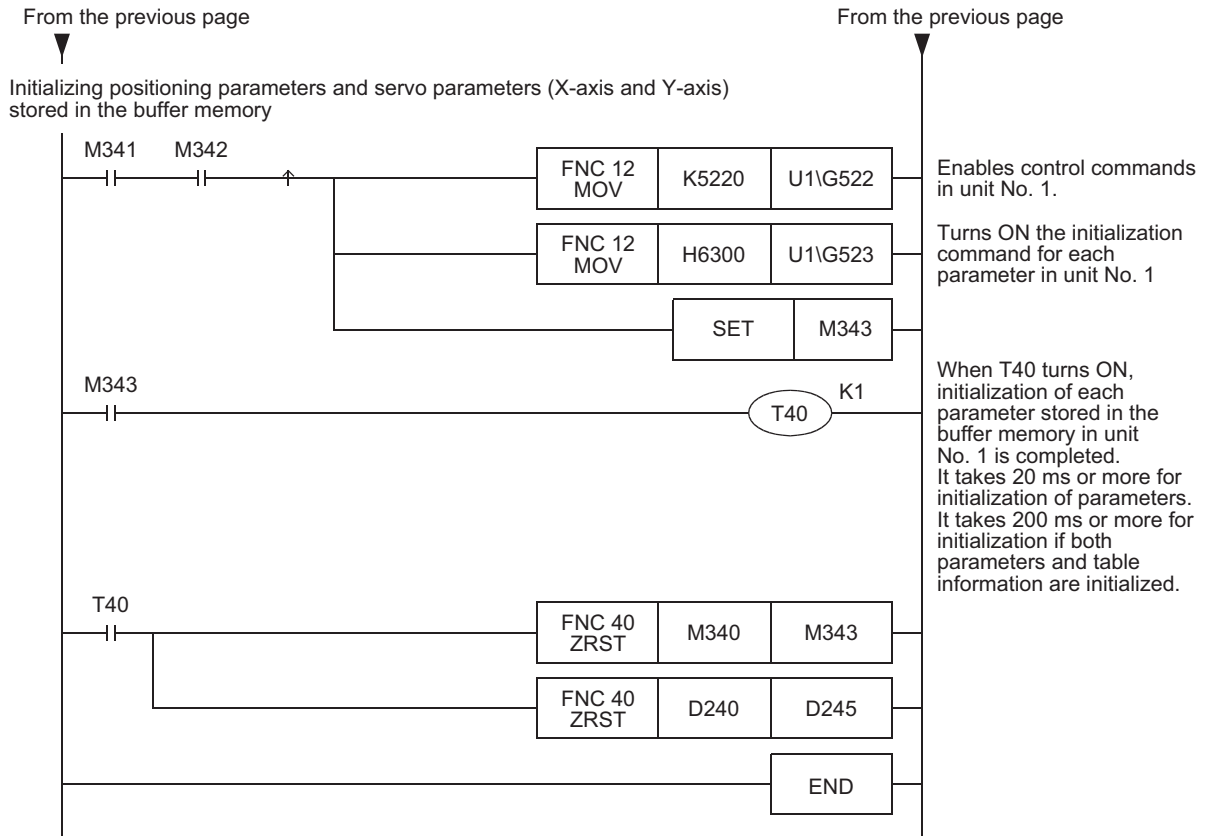

Caution

When this program example is executed in the 20SSC-H Ver. 1.10 or later, the servo parameter automatic update function (which reads servo parameters automatically from the servo amplifier) is stopped in both the X-axis and Y-axis.

After executing this program example, set the parameters.

When the setting of servo parameters (including transfer of servo parameters to the servo amplifier) is completed, set the servo parameter update stop command to OFF, or restart the system.

→ For the method to set parameters using a sequence program, refer to Subsection 7.1.4 or 7.1.5

7.1.7 Updating positioning parameters [sequence program]

This subsection explains the method to enable positioning parameters changed in a sequence program.

→ For direct specification of the buffer memory using the FROM/TO instruction and applied instructions, refer to Section 12.1 and the PROGRAMMING MANUAL

- 1) Set the following positioning parameters stored in the buffer memory using a sequence program. Create a program which sets positioning parameters by direct specification of the buffer memory using the FROM/TO instruction and applied instructions, and then save set values to the buffer memory.
→ For the contents of setting of positioning parameters, refer to Section 11.1

	BFM Number	
	X-axis	Y-axis
Positioning parameters	BFM #14000 to #14199	BFM #14200 to #14399

- 2) Set to ON from OFF the positioning parameter enable command.
If the positioning parameter enable command is set to ON from OFF while the target axis is not performing a positioning operation, the system will use the positioning parameters stored in the buffer memory from the next positioning operation.

If this command is not executed, the system performs positioning operation using the positioning parameters stored in the flash memory.

→ For the operation command 2, refer to Subsection 11.4.11

		BFM Number		Description
		X-axis	Y-axis	
Operation command 2	Positioning parameter enable command	BFM #519 b4	BFM #619 b4	Set these bits to ON from OFF using a sequence program.
Status information 2	Positioning parameter change completion flag (Ver. 1.20 or later)	BFM #32 b0	BFM #132 b0	<ul style="list-style-type: none"> • These bits turn ON when change of positioning parameters is completed. • These bits turn OFF automatically when the positioning parameter enable command is set to OFF.

Program example

In this program example, the following positioning parameters in unit No. 1 are changed, and then the changed positioning parameters are enabled.

Item		BFM Number		Description
		X-axis	Y-axis	
Positioning parameters	JOG speed	BFM #14013, #14012	BFM #14213, #14212	Set K1,000,000.

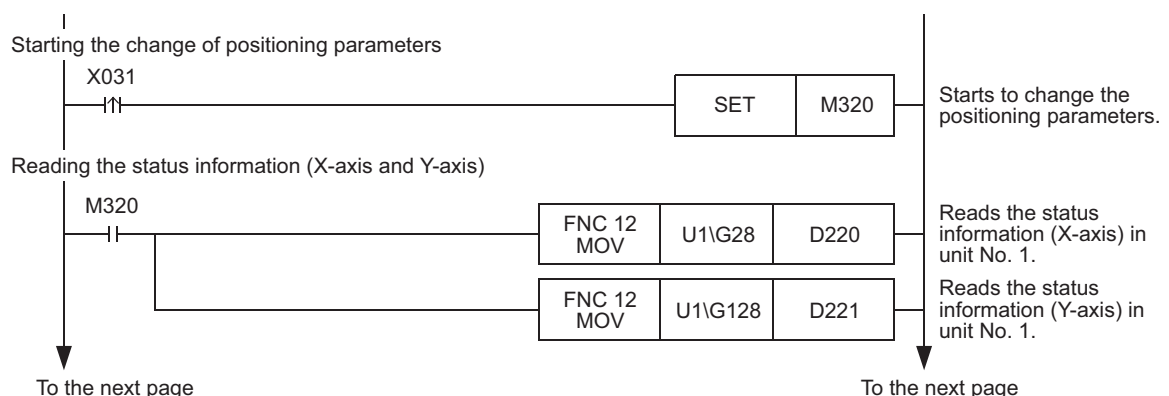

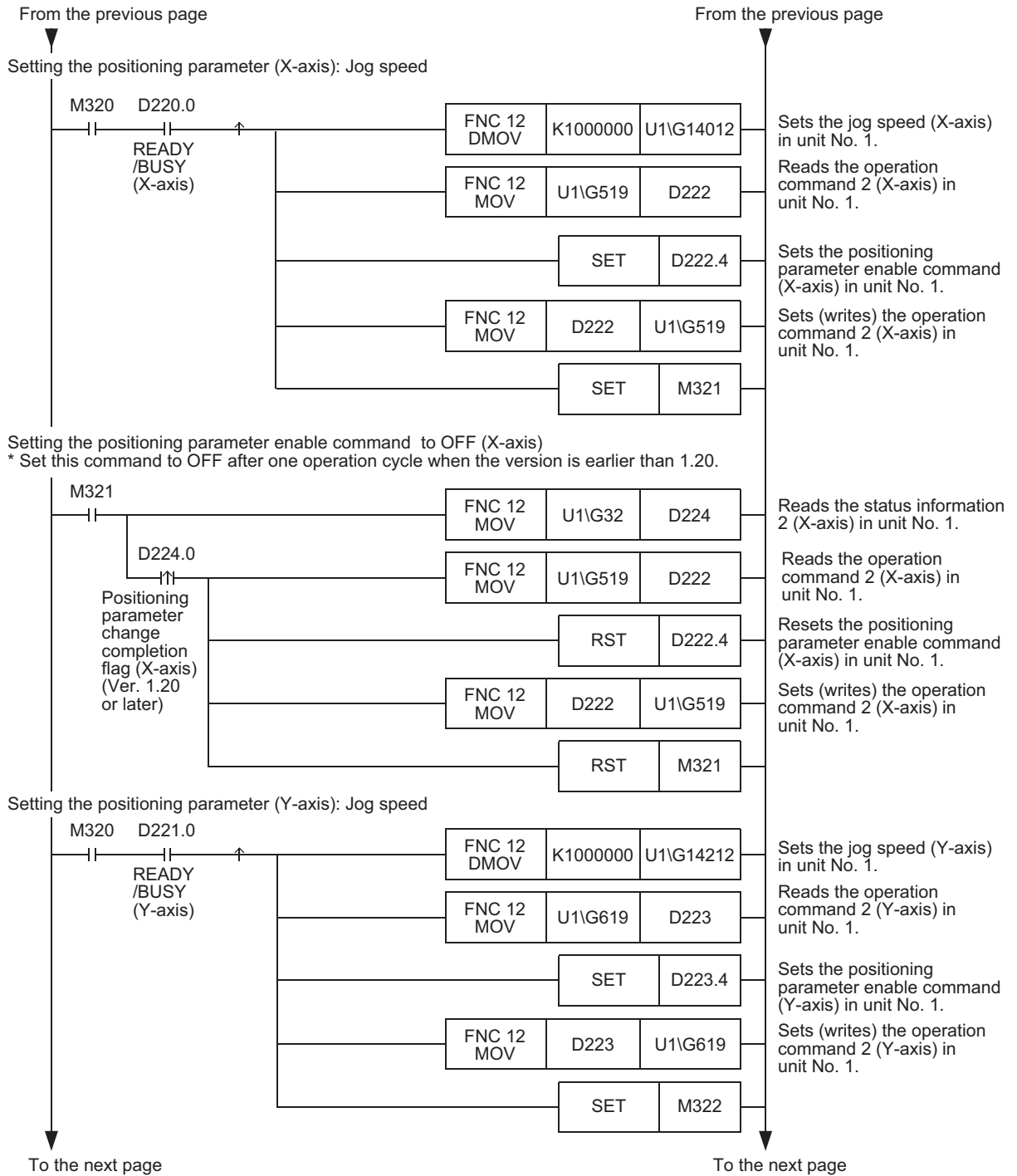

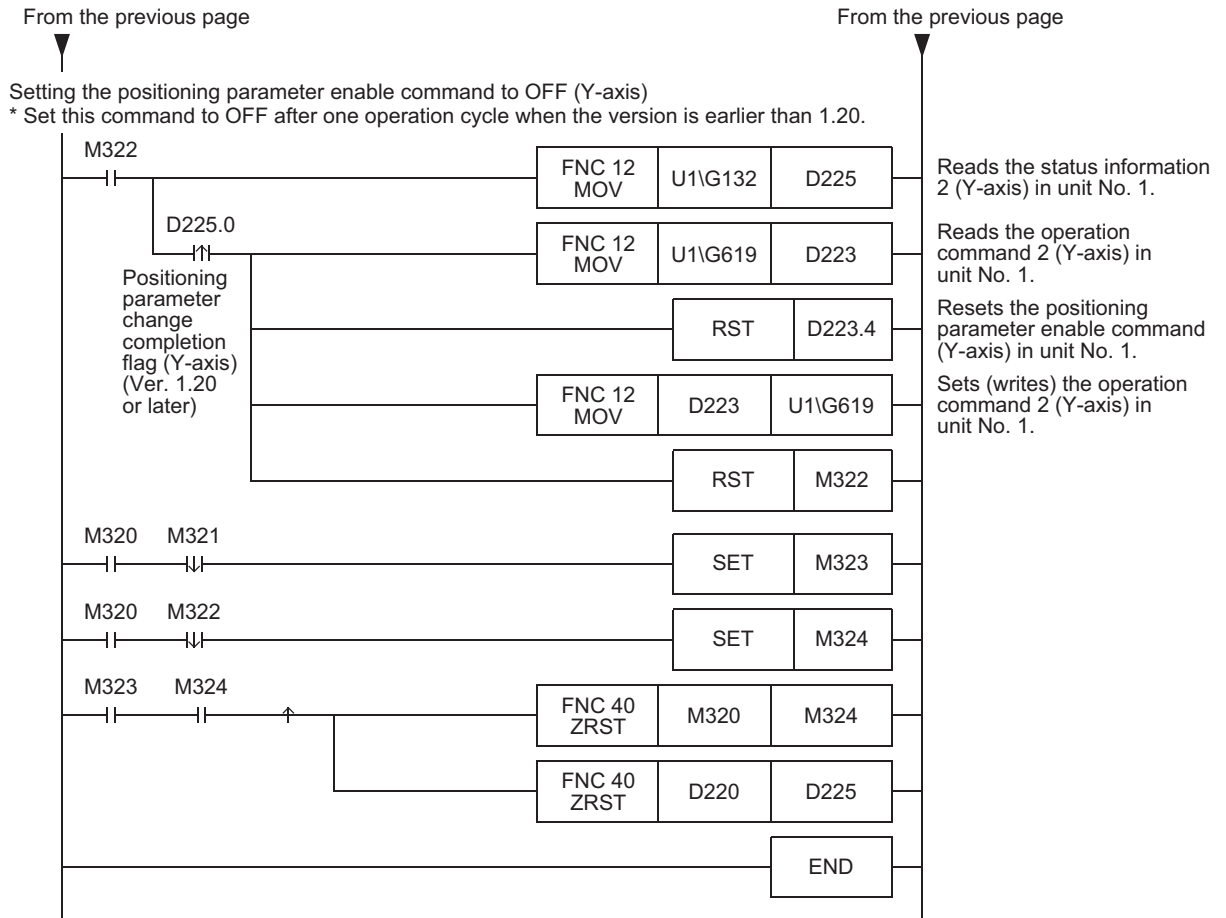

- 1** Introduction
- 2** System configuration
- 3** Specifications
- 4** Installation
- 5** Wiring
- 6** Memory Config and data operation
- 7** Before starting positioning operation
- 8** Manual control
- 9** Positioning Control
- 10** Table Operation

7.1.8 Updating some servo parameters [sequence program]

This subsection explains how to transfer the following servo parameters changed using a sequence program to the servo amplifier.

The table below shows transferrable servo parameters in accordance with the setting of the auto tuning mode.

→ For operation command 2, refer to Subsection 11.4.11

→ For direct specification of the buffer memory using the FROM/TO instruction and applied instructions, refer to Section 12.1 and the PROGRAMMING MANUAL

	Auto tuning mode setting status			
	Interpolation mode	Auto tuning mode 1	Auto tuning mode 2	Manual mode
Auto tuning mode	✓	✓	✓	✓
Auto tuning response	✓	✓	✓	✓
Feed forward gain	✓	✓	✓	✓
Ratio of load inertia moment to servo motor inertia moment	*1	*2	✓	✓
Model loop gain	✓	*2	*3	✓
Position loop gain	*1	*2	*3	✓
Speed loop gain	*1	*2	*3	✓
Speed integral compensation	*1	*2	*3	✓
Speed differential compensation	✓	✓	✓	✓

*1. These parameters are automatically adjusted in the interpolation mode.

*2. These parameters are automatically adjusted in auto tuning mode 1.

*3. These parameters are automatically adjusted in auto tuning mode 2.

Note: Servo parameter transfer command execution condition

The servo parameter transfer command is enabled when the "READY/BUSY" bit in the status information is "READY (ON)."

The servo parameter transfer command is ignored while the system is performing positioning operation.

- 1) Set the following servo parameters to be transferred stored in the buffer memory.
Create a program which sets servo parameters by direct specification of the buffer memory using the FROM/TO instruction and applied instructions, and then save set values to the buffer memory.

→ For the contents of setting of servo parameters, refer to Section 11.2

	BFM Number		Description
	X-axis	Y-axis	
Auto tuning mode	BFM #15008	BFM #15208	Set these parameters in accordance with the system. Transferrable servo parameters vary depending on the setting of the auto tuning mode (as shown in the above table). → For details, refer to the servo amplifier manual
Auto tuning response	BFM #15009	BFM #15209	
Feed forward gain	BFM #15022	BFM #15222	
Ratio of load inertia moment to servo motor inertia moment	BFM #15024	BFM #15224	
Model loop gain	BFM #15025	BFM #15225	
Position loop gain	BFM #15026	BFM #15226	
Speed loop gain	BFM #15027	BFM #15227	
Speed integral compensation	BFM #15028	BFM #15228	
Speed differential compensation	BFM #15029	BFM #15229	

- 2) Transfer target servo parameters to the servo amplifier.
Set to ON from OFF the servo parameter transfer command.
The "During servo parameter transfer" bits remain ON while servo parameters are being transferred.
→ For operation command 2, refer to Subsection 11.4.11
→ For the status information, refer to Subsection 11.3.17

		BFM Number		Description
		X-axis	Y-axis	
Operation command 2	Servo parameter transfer command	BFM #519 b9	BFM #619 b9	Set these bits to ON from OFF using a sequence program.
Status information	During servo parameter transfer	BFM #28 b10	BFM #128 b10	These bits remain ON while servo parameters are being transferred by the servo parameter transfer command. These bits turn OFF automatically when transfer of servo parameters is completed.

- 3) When transfer of servo parameters is completed (that is, when the During servo parameter transfer bits automatically turn OFF from ON), set to OFF the servo parameter transfer command.

		BFM Number		Description
		X-axis	Y-axis	
Operation command 2	Servo parameter transfer command	BFM #519 b9	BFM #619 b9	Set these bits to OFF from ON using a sequence program.
Status information	During servo parameter transfer	BFM #28 b10	BFM #128 b10	These bits remain ON while servo parameters are being transferred by the servo parameter transfer command. These bits turn OFF automatically when transfer of servo parameters is completed.

Program example

In this program, the following servo parameters in unit No. 1 are changed, and then the changed servo parameters are transferred to the servo amplifier.

Item	BFM Number		Description
	X-axis	Y-axis	
Auto tuning mode	BFM #15008	BFM #15208	Set H0001 to select auto tuning mode 1.
Auto tuning response	BFM #15009	BFM #15209	Set K12.

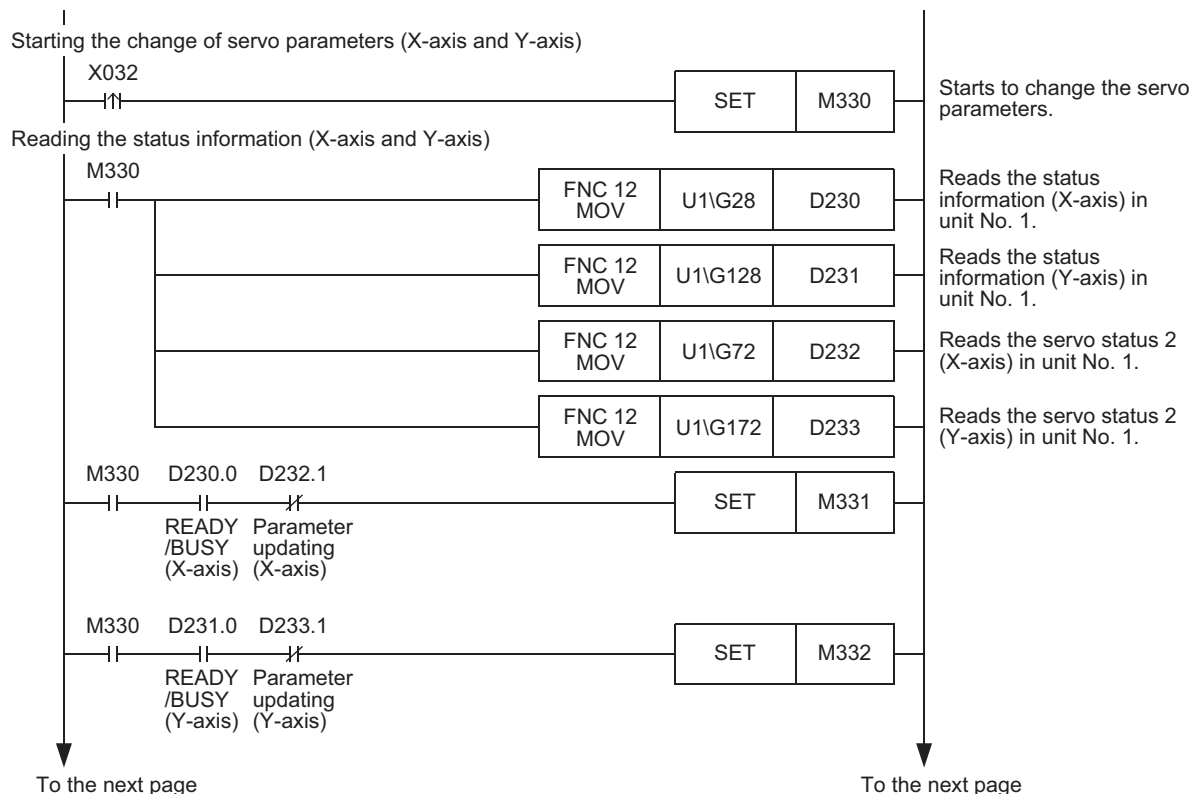

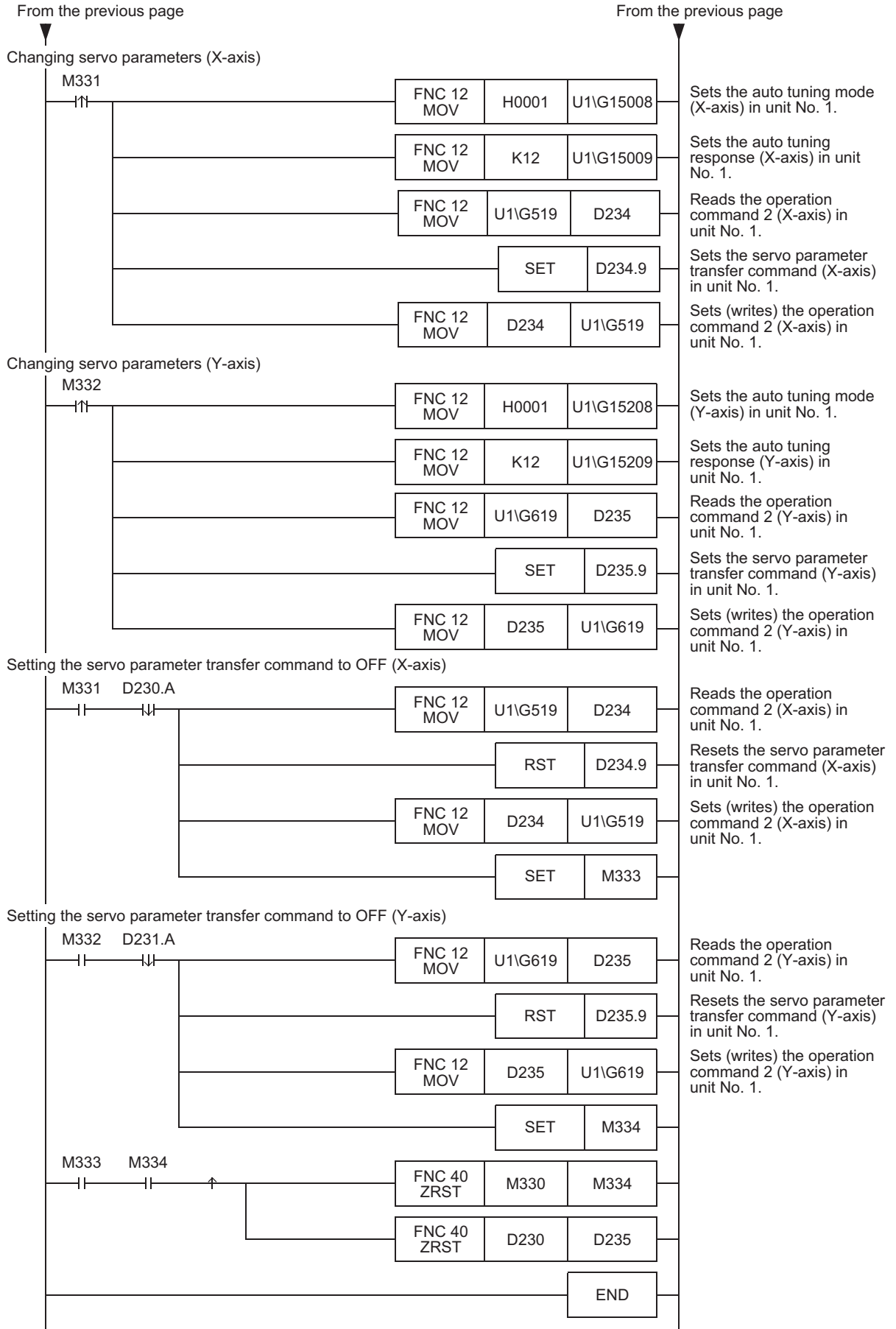

7.1.9 Saving parameters and table information to flash memory [sequence program]

This subsection explains how to save the positioning parameters, servo parameters and table information stored in the buffer memory to the flash memory using a sequence program.

→ For direct specification of the buffer memory using the FROM/TO instruction and applied instructions, refer to Section 12.1 and the PROGRAMMING MANUAL

Note

Make sure to set the positioning parameters and servo parameters stored in the flash memory as follows.

- Positioning parameters (Ver. 1.10 or later)

Set the servo parameter transfer mode as follows.

→ For the operation parameter 2, refer to Subsection 11.1.2

		BFM Number		Description
		X-axis	Y-axis	
Operation parameter 2	Servo parameter transfer mode	BFM #14002 b15	BFM #14202 b15	Set these bits to OFF using a sequence program (so that the contents of the flash memory will be transferred to the servo amplifier).

- Servo parameters

Set the servo series as follows.

		BFM Number		Description
		X-axis	Y-axis	
Servo series		BFM #15000	BFM #15200	Set the servo amplifier series connected to the 20SSC-H using a sequence program. 1: MR-J3-B*1 3: MR-J3-BS*2

*1. When connecting the MR-J3W-□B, set "1: MR-J3-B" as the servo series.

*2. The MR-J3-BS can be set for 20SSC-H blocks Ver.1.40 or later.

When connecting the MR-J4W2-□B, set "3: MR-J3-BS" as the servo series.

- 1) Enable (make valid) control commands.

→ For control command enable/disable, refer to Subsection 11.4.14

		BFM Number		Description
		X-axis	Y-axis	
Control command enable/disable		BFM #522		Write K5220 using a sequence program.

- 2) Set to ON from OFF the positioning parameter save command, servo parameter save command and table information save command.

→ For the control commands, refer to Subsection 11.4.15

		BFM Number		Description
		X-axis	Y-axis	
Control command	Positioning parameters save command	BFM #523 b0	BFM #523 b1	Set these bits to ON from OFF using a sequence program.
	Table information save command (X-axis and Y-axis)	BFM #523 b2	BFM #523 b3	Set these bits to ON from OFF using a sequence program.
	Table information save command (XY-axis)	BFM #523 b4		Set these bits to ON from OFF using a sequence program.
	Servo parameters save command	BFM #523 b5	BFM #523 b6	Set these bits to ON from OFF using a sequence program.
Status information	Saving to flash memory	BFM #28 b11		<ul style="list-style-type: none"> These bits remain ON while the data stored in the buffer memory is being saved to the flash memory. These bits automatically turn OFF when saving is completed.

Program example

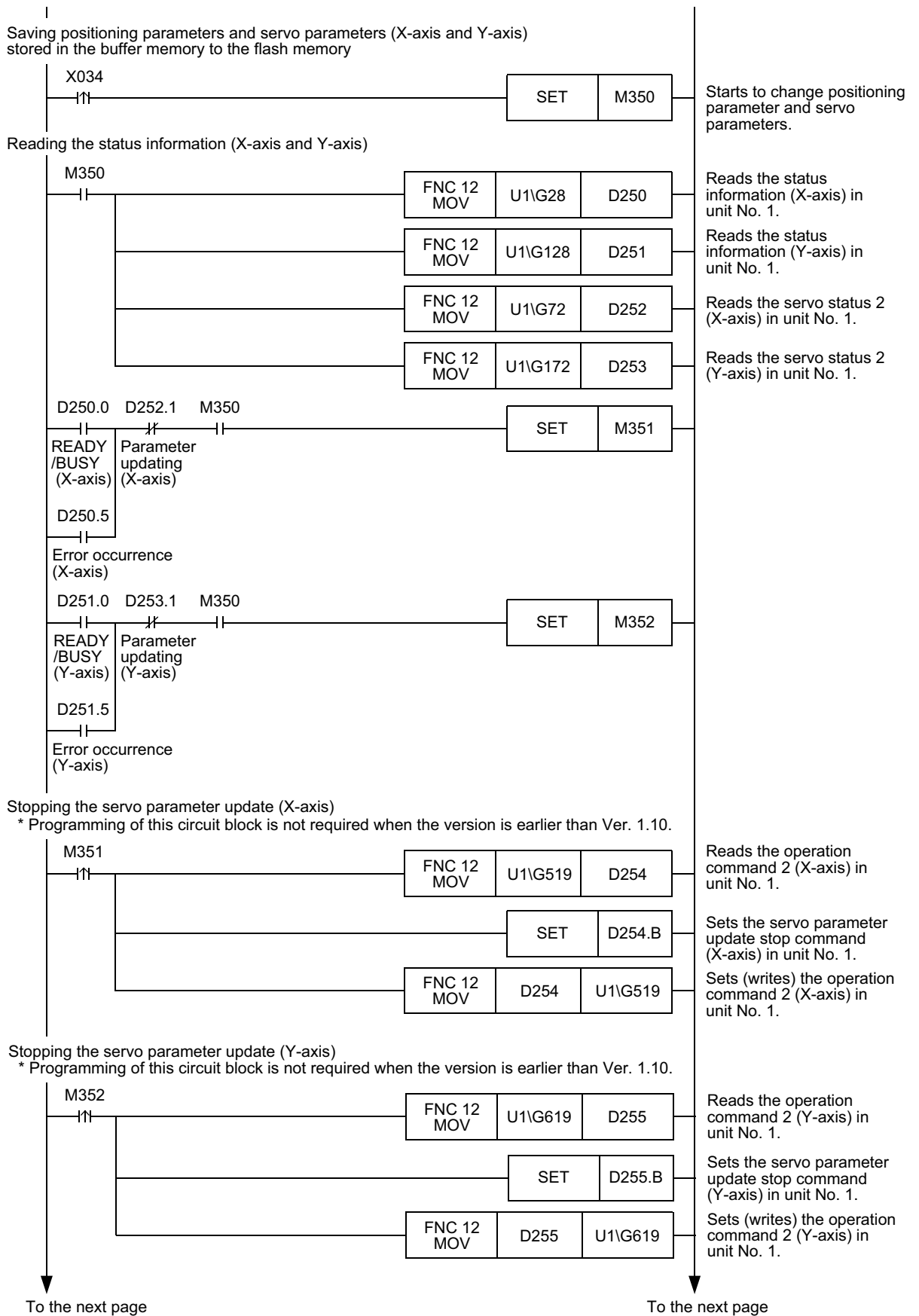

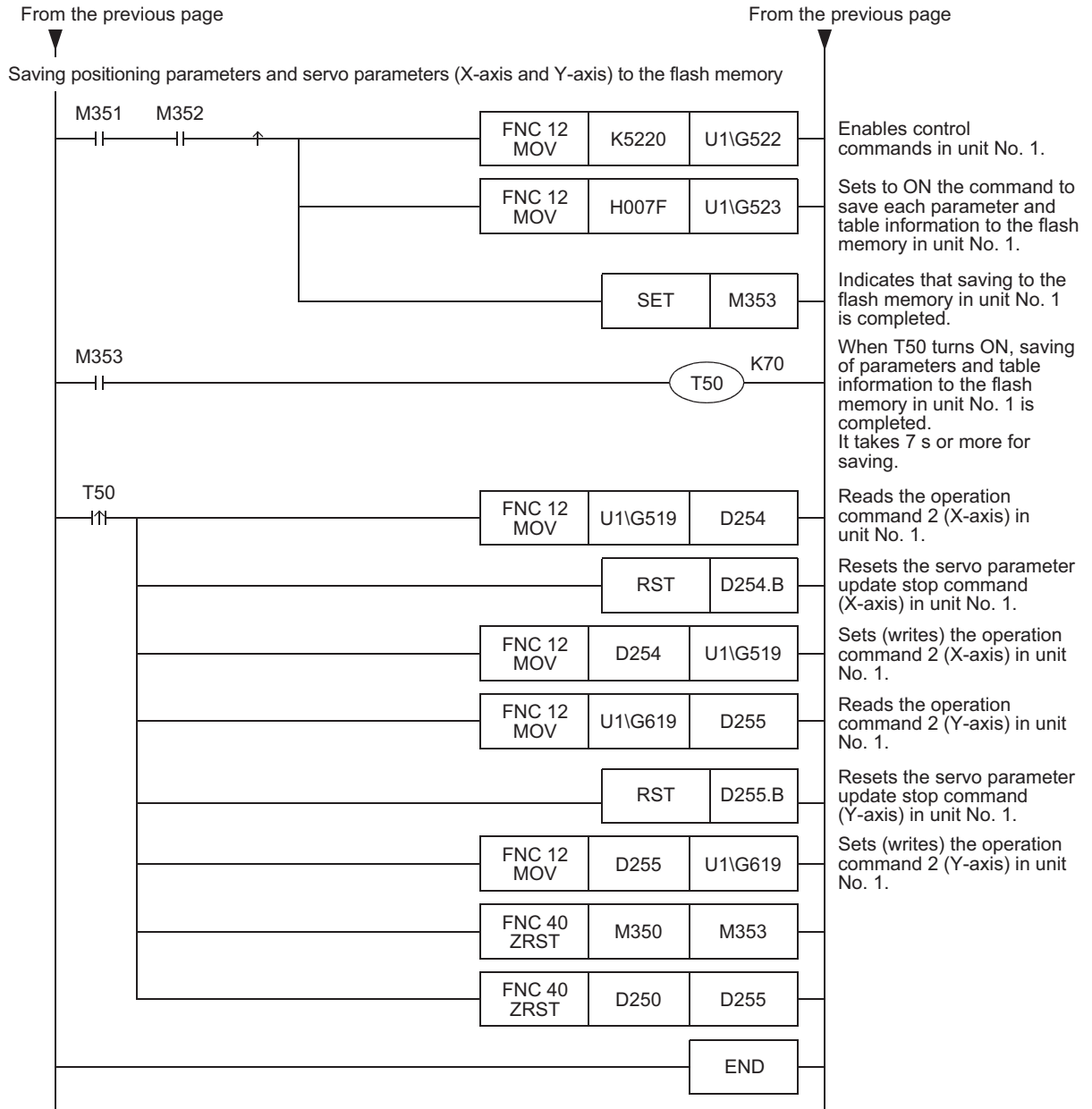

- 1** Introduction
- 2** System configuration
- 3** Specifications
- 4** Installation
- 5** Wiring
- 6** Memory Config¹ and data operation
- 7** Before starting positioning operation
- 8** Manual control
- 9** Positioning Control
- 10** Table Operation

7.2 Outline of Positioning Operation

The relationship between the operation speed, acceleration/deceleration time and travel distance of the positioning operation is shown below.

For further details on the positioning operations supported by 20SSC-H and a note on positioning cautions, refer to the following.

- For a note on positioning cautions, refer to the next page
- For the parameter setting and change methods, refer to Section 7.1
- For the parameters, control data and monitor data, refer to Chapter 11
- For the operation speed and target address change methods, refer to Section 7.6
- For selection of the acceleration/deceleration time, refer to Section 7.7
 - For manual operation, refer to Chapter 8
- For positioning operations other than table operation, refer to Chapter 9
 - For table operation, refer to Chapter 10
- For program examples, refer to Chapter 12

In individual axis operation

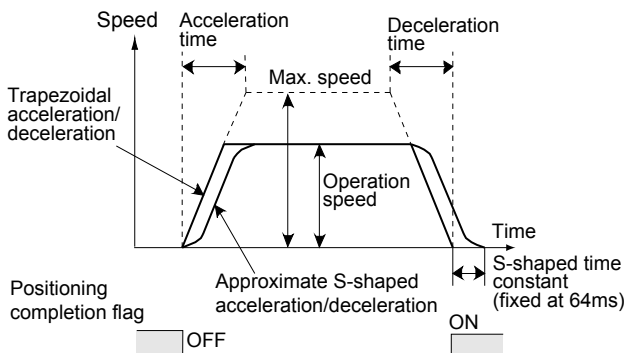

In simultaneous two-axis operation (interpolation operation)

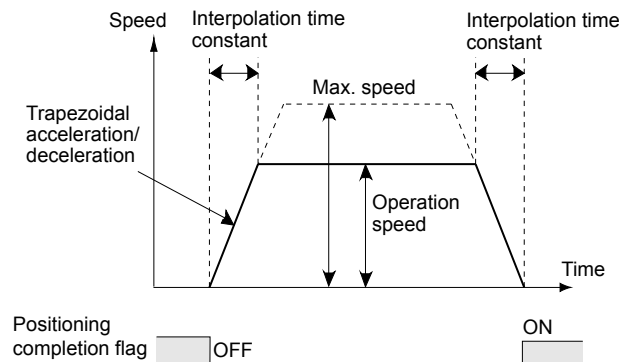

Parameters and control data used for positioning operation

Item	BFM number		Description	
	X-axis	Y-axis		
Maximum speed	BFM #14009,#14008	BFM #14209,#14208	Upper limit of speed in each operation mode	
Operation speed	Operation speed 1	BFM #503,#502	BFM #603,#602	Actual operation speed in each operation mode
	Operation speed 2	BFM #507,#506	BFM #607,#606	Actual operation speed for two-speed positioning operation and interrupt two-speed positioning
	JOG speed	BFM #14013,#14012	BFM #14213,#14212	Manual forward/reverse JOG operation speed
Acceleration/deceleration mode [Operation parameter 1]	BFM #14000 b11	BFM #14200 b11	Select the control method adopted during acceleration/deceleration. Trapezoidal acceleration/deceleration is automatically adopted during interpolation operation. OFF: Adopts trapezoidal acceleration/deceleration. ON: Adopts approximate S-shaped acceleration/deceleration usually, but adopts trapezoidal acceleration/deceleration only during interpolation operation.	
Acceleration/deceleration time change command (Ver. 1.30 or later) [Operation command 2]	BFM #519 b5	BFM #619 b5	Select the acceleration/deceleration time adopted during acceleration/deceleration. The interpolation time constant is automatically adopted for the acceleration/deceleration time during interpolation operation. → For selection of the acceleration/deceleration time, refer to Section 7.7 OFF: Performs positioning operation using the acceleration time and deceleration time. ON: Performs positioning operation using the acceleration time 2 and deceleration time 2.	

Item	BFM number		Description	
	X-axis	Y-axis		
Acceleration /deceleration time	Acceleration time	BFM #14018	BFM #14218	Time needed to reach the maximum speed from zero speed
	Acceleration time 2 (Ver. 1.30 or later)	BFM #14108	BFM #14308	
	Deceleration time	BFM #14020	BFM #14220	Time needed to reach zero speed from the maximum speed
	Deceleration time 2 (Ver. 1.30 or later)	BFM #14110	BFM #14310	
	Interpolation time constant	BFM #14022	BFM #14222	Acceleration/deceleration time for interpolation operation. Time to reach the operation speed from zero speed (for acceleration) or time to reach zero speed from operation speed (for deceleration)
Travel distance	Target address 1	BFM #501,#500	BFM #601,#600	Target position (absolute address) or travel distance (relative address) in each operation mode
	Target address 2	BFM #505,#504	BFM #605,#604	Target position (absolute address) or travel distance (relative address) for two-speed positioning operation
Positioning completion [Status information]	BFM #28 b6	BFM #128 b6	<p>The flag is reset at the beginning of each operation or at the error occurrence, and it is set upon normal completion. However, the flag is not set during stop operation or for the following operations even if the operation finishes normally.</p> <ul style="list-style-type: none"> • JOG operation • Mechanical zero return (data setting type) • Manual pulse generator operation • Variable speed operation 	

Note

- Trapezoidal acceleration/deceleration and approximate S-shaped acceleration/deceleration
If trapezoidal acceleration/deceleration and approximate S-shaped acceleration/deceleration are performed under the same conditions (travel distance, operation speed and acceleration/deceleration time), the positioning time for the approximate S-shaped acceleration/deceleration is longer by 64ms.
- Approximate S-shaped acceleration/deceleration
Specify 64ms or more (64 to 5000) for the acceleration time, acceleration time 2, deceleration time or deceleration time 2.
- If the operation speed [jog speed, operation speed 1, operation speed 2, zero return speed (high speed) or zero return speed (creep)] is 0Hz, operation is performed at 1Hz.
- When the operation speed is changed by the override function during interpolation operation, the acceleration/deceleration time (interpolation time constant) changes according to the ratio by which the operation speed changes

→ For override function details, refer to Subsection 7.6.1

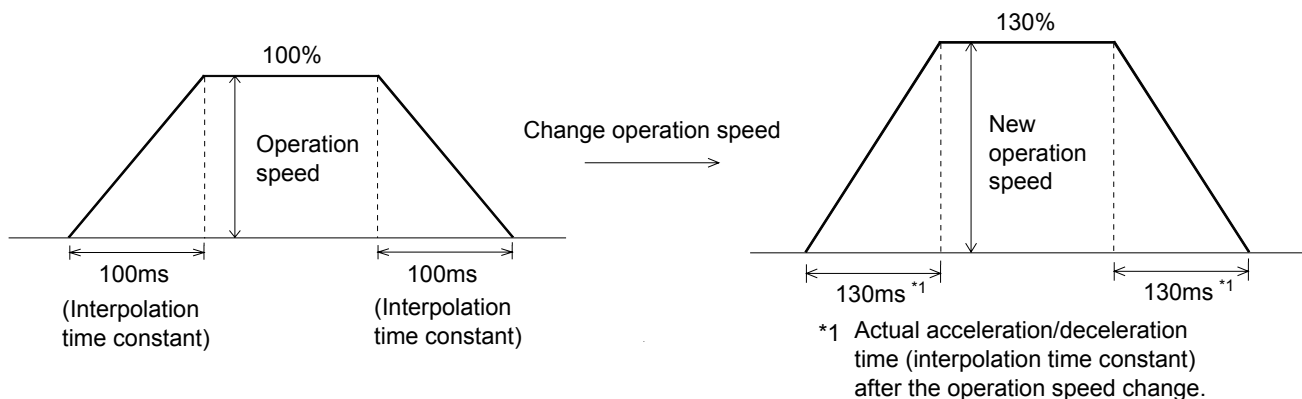

- An error occurs when the relative travel distance converted into pulse between the current address and the target address exceeds the range from -2,147,483,647 to 2,147,483,647 while absolute addresses are specified
- Select the acceleration/deceleration time before starting positioning operation.
If the acceleration/deceleration time selection is changed during positioning operation, the system will perform the following operation depending on the operation status:
 - When the acceleration/deceleration time selection is changed during acceleration/deceleration
The system will operate using the new acceleration/deceleration time. However, attention should be paid to positioning operation because the acceleration time setting may not be changed with the intended timing.
 - When the acceleration/deceleration time selection is changed during positioning operation at operation speed
The system will operate using the new deceleration time. If the acceleration/deceleration time selection is changed just before start of deceleration, the deceleration time setting may not be changed.
If the time needed for the remaining travel distance is shorter than the time needed for deceleration after a change, the pulse output may decrease suddenly during deceleration.
For 2-speed positioning operation, interrupt 2-speed constant quantity feed, variable speed operation and multi-speed operation, the system will operate using the new acceleration/deceleration time.
 - When the acceleration/deceleration time selection is changed during deceleration
The system will operate using the deceleration time before the change.
However, for 2-speed positioning operation, interrupt 2-speed constant quantity feed, variable speed operation and multi-speed operation, the system will operate using the new acceleration/deceleration time.

7.3 Handling the Forward Rotation Limit and Reverse Rotation Limit

The concept of the forward rotation limit and that of the reverse rotation limit are described. Suppose that limit switches are located as shown in the figure below.

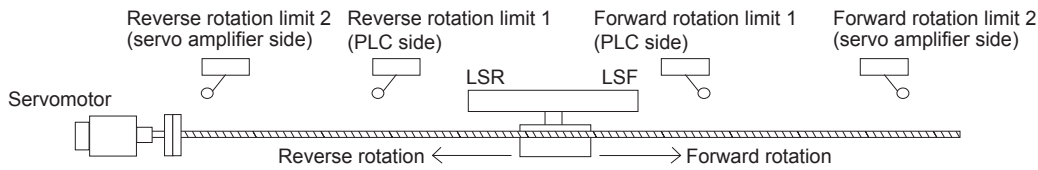

Limit		Stopping action	Description	Reference
Servo amplifier	Forward rotation limit 2, reverse rotation limit 2	Deceleration to stop*1	Specify the action limit so that no damage is caused to the machine that decelerates to stop after activation of the limit switch.	Subsection 7.3.1
PLC	Forward rotation limit 1, reverse rotation limit 1	Deceleration to stop*1	Provide at positions so that the limit switch is activated before forward rotation limit 2 or reverse rotation limit 2 connected with the servo amplifier.	Subsection 7.3.2
Software limit (upper) Software limit (lower)		Deceleration to stop*1	Operation limit based on the current address that is effective after mechanical zero return. Specify at addresses where activation is caused before the forward rotation limit 1 or reverse rotation limit 1 connected with the PLC.	Subsection 7.3.3

*1. Sudden stop or deceleration stop can be selected with Ver.1.20 or later.

→ For details, refer to Section 7.5

Note

- The 20SSC-H does not have a terminal for connecting the forward or reverse rotation limit switch. Connect the forward and reverse rotation limit switches to the PLC and/or servo amplifier.
- Provide the forward/reverse rotation limit when using the DOG search function in a DOG type mechanical zero return. The DOG search function operates, even if the forward/reverse rotation limit are provided in either a PLC or the servo amplifier side.

How to restart after the limit switch is activated

When the limit switch is activated, the work piece decelerates to stop, and a limit error occurs. The work piece cannot move to the activated limit-switch side. Use the JOG operation in opposite direction or the manual pulse generator in the opposite direction to avoid the limit error.

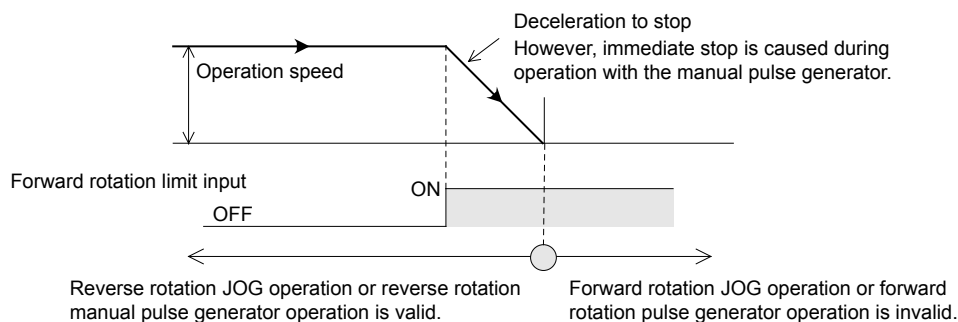

- 1 Introduction
- 2 System configuration
- 3 Specifications
- 4 Installation
- 5 Wiring
- 6 Memory Config. and data operation
- 7 Before starting positioning operation
- 8 Manual control
- 9 Positioning Control
- 10 Table Operation

7.3.1 Forward rotation limit 2 (FLS) and reverse rotation limit 2 (RLS) [Servo amplifier limit]

Connect forward rotation limit 2 (FLS) and reverse rotation limit 2 (RLS) to the upper stroke limit (FLS) and lower stroke limit (RLS) external signal terminals of the servo amplifier, respectively. This limit switch should be provided in a position to avoid causing damage to the machine after activation.

- For sudden stop performed when the stroke limit switch turns ON in the servo amplifier, refer to Section 7.5
- For parameters, control data and monitor data, refer to Chapter 11

1. Wiring the forward rotation limit 2 (FLS) and reverse rotation limit 2 (RLS)

Connect forward rotation limit 2 (FLS) and reverse rotation limit 2 (RLS) to the upper stroke limit (FLS) and lower stroke limit (RLS) external signal terminals of the servo amplifier, respectively.

- For terminal names and wiring in the servo amplifier, refer to the servo amplifier manual

2. Servo amplifier external signal setting

Set the external input selection (positioning parameter) as follows.

- For details, refer to Subsection 11.1.20

		BFM Number		Description
		X-axis	Y-axis	
External input selection	Selection of FLS/ RLS signal	BFM #14044 b0	BFM #14244 b0	Select "Use the forward rotation limit and reverse rotation limit in the servo amplifier and PLC." (Set b0 to ON.)
	Logic of FLS/ RLS signal	BFM #14044 b8	BFM #14244 b8	Select "N/C contact (servo amplifier)." (Set b8 to ON.)

3. Restarting method

Refer to the following.

- Refer to Section 7.3 (on the previous page)

7.3.2 Forward rotation limit 1 (LSF) and reverse rotation limit 1 (LSR) [PLC side limit]

Control the operation command 1 of the 20SSC-H using a sequence program.

Provide at a position so that activation is caused before forward rotation limit 2 or reverse rotation limit 2 connected to the servo amplifier.

- For sudden stop operation performed when the rotation limit switch turns ON, refer to Section 7.5
- For parameters, control data and monitor data, refer to Chapter 11

1. Wiring the forward rotation limit 1 (LSF) and reverse rotation limit 1 (LSR)

Connect forward rotation limit 1 (LSF) and reverse rotation limit 1 (LSR) at the input terminals of the PLC. For details on the PLC wiring method, refer to the following respective PLC manual.

- Refer to the FX3U Hardware Manual
- Refer to the FX3UC Hardware Manual

2. Specifying forward rotation limit 1 (LSF) and reverse rotation limit 1 (LSR)

Operate the forward rotation limit 1 (LSF) and reverse rotation limit 1 (LSR) connected with the PLC with the forward rotation limit flag and reverse rotation limit flag in Operation command 1, respectively.

- For the operation command 1, refer to Subsection 11.4.10
- For program examples, refer to Chapter 12

		BFM Number		Description
		X-axis	Y-axis	
Operation command 1	Forward rotation limit (LSF)	BFM #518 b2	BFM #618 b2	Set this to perform a deceleration stop while outputting pulses for forward rotation.
	Reverse rotation limit (LSR)	BFM #518 b3	BFM #618 b3	Set this to perform a deceleration stop while outputting pulses for reverse rotation.

3. Restarting method

Refer to the following.

- Refer to Section 7.3 (on the previous page)

7.3.3 Software limit

This operation limit is based on the 0 address that becomes valid after a mechanical zero return. Specify each software limit in positioning parameters at addresses so that activation is before forward rotation limit 1 and reverse rotation limit 1 connected with the PLC.

- For sudden stop operation performed when the software limit turns ON, refer to Section 7.5
- For parameters, control data and monitor data, refer to Chapter 11

	BFM Number		Description
	X-axis	Y-axis	
Software limit (upper)	BFM #14035, #14034	BFM #14235, #14234	Sets the software limit (upper) Setting range: -2,147,483,648 to 2,147,483,647 (user unit) ^{*1}
Software limit (lower)	BFM #14037, #14036	BFM #14237, #14236	Sets the software limit (lower) Setting range: -2,147,483,648 to 2,147,483,647 (user unit) ^{*1}

*1. However, set the value within -2,147,483,648 to 2,147,483,647 PLS in converted pulse data. Refer to the section shown below for details on the user units and converted pulse data.

→ Refer to Section 7.10

Conditions for validating the software limit

- Specify the software limit so that the following condition is satisfied.
Large software limit > small software limit
- State with active zero return complete flag
(After execution of mechanical zero return and completion of positioning at the zero-point, or in an absolute position detection system where the current value is established)
→ For details of the status information, refer to Subsection 11.3.17

		BFM Number		Description
		X-axis	Y-axis	
Status information	Zero return complete	BFM #28 b3	BFM #128 b3	Turns ON upon completion of mechanical zero return operation, or when the current position is established by the absolute position detection system. Turns OFF at OFF-to-ON transition of a mechanical zero return command, at power-off (reset), or when an absolute position is lost by the absolute position detection system.

Note

To refrain from using the software limit, specify the software limit settings as shown below.

- Software limit (upper) = Software limit (lower)
- Software limit (upper) < Software limit (lower)

Cautions for use of software limit

- 1) The software limit is invalid under the following control situations.
 - Mechanical zero return operation
 - Current value change
 - Ring counter setting (Ver.1.10 or later)
- 2) The limit error of the software limit is changed at the starting and end points of the operation. Therefore the specified upper or lower software limit may be exceeded in circular interpolation control. In this case, deceleration does not occur even if the software limit is exceeded. If there is a possibility of overshoot beyond the software limit, install an external limit switch.

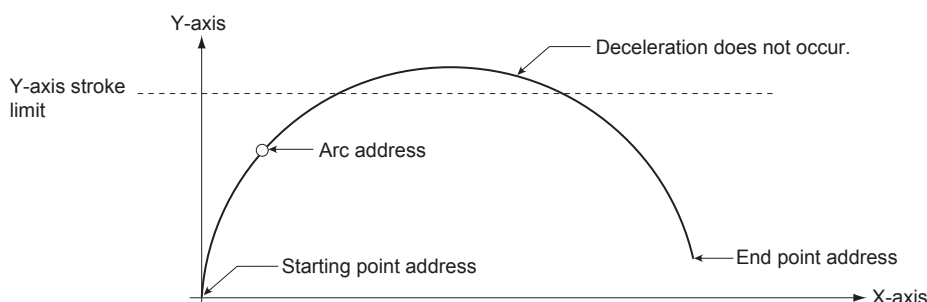

- 1 Introduction
- 2 System configuration
- 3 Specifications
- 4 Installation
- 5 Wiring
- 6 Memory Config. and data operation
- 7 Before starting positioning operation
- 8 Manual control
- 9 Positioning Control
- 10 Table Operation

7.4 Handling the STOP command

When the STOP command of 20SSC-H turns ON during positioning operation, the servomotor decelerates to stop.*1

When stopped by the STOP command, the following status informations are shown below.

*1. Sudden stop or deceleration stop can be selected with Ver.1.20 or later.

- For selection of sudden stop/deceleration stop, refer to Section 7.5
- For the parameters, control data and monitor data, refer to Chapter 11
- For details of the operation command 1, refer to Subsection 11.4.10

		BFM Number		Description
		X-axis	Y-axis	
Operation command 1	STOP command	BFM #518 b1	BFM #618 b1	When this bit turns ON, the positioning operation decelerates to stop. With this bit ON, the stop-state continues.

Status information state

→ For details of the status information, refer to Subsection 11.3.17

		BFM Number		State after stop
		X-axis	Y-axis	
Status information	READY/BUSY	BFM #28 b0	BFM #128 b0	ON
	Positioning completion	BFM #28 b6	BFM #128 b6	OFF

1. STOP command during JOG operation, manual pulse generator operation or variable speed operation

When a STOP command is turned ON during the JOG operation, manual pulse generator operation or variable speed operation, the servomotor decelerates to a stop without regard to the stop mode setting type. The table above shows the positioning completion flag state when the servo motor stops.

Operation stop for JOG operation, manual pulse generator operation or variable speed operation

To stop the JOG operation, manual pulse generator operation or variable speed operation, turn the operation command to off or stop the manual pulse generator input. (without using the STOP command)
Operation is restarted when the STOP command is turned off and the forward or reverse rotation JOG command is ON, the manual pulse generator or variable speed operation is being operated.

- For jog operation, refer to Section 8.2
- For manual pulse generator operation, refer to Section 8.3
- For variable speed operation, refer to Section 9.7

2. STOP command during positioning operation (without the JOG operation, manual pulse generator operation or variable speed operation)

When the STOP command is turned ON during positioning control operation, the operation is as follows according to the stop mode setting. There are two types of stop mode: the positioning control end mode and remaining travel distance operation mode.

1) Positioning control end mode

When the STOP command is turned ON, operation decelerates to a stop and is terminated.

When the STOP command is OFF, positioning operation begins when the START command is turned ON.

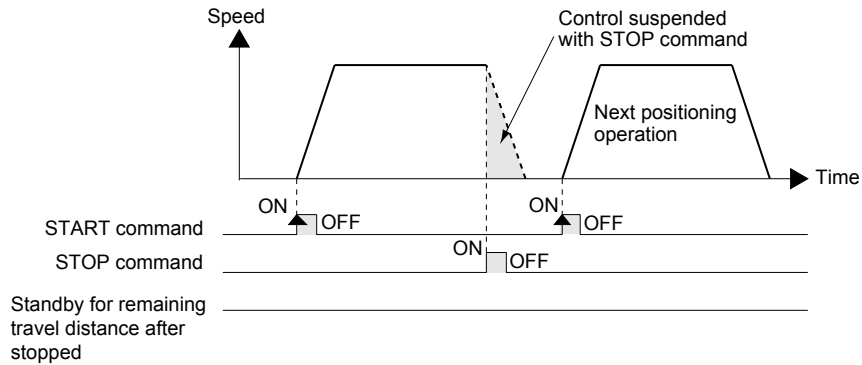

		BFM Number		Data type
		X-axis	Y-axis	
START command	Operation command 1	BFM #518 b9	BFM #618 b9	Control data
STOP command	Operation command 1	BFM #518 b1	BFM #618 b1	Control data
Standby for remaining travel distance at stop	Status information	BFM #28 b7	BFM #128 b7	Monitor data

2) Remaining travel distance operation mode

When the STOP command is turned ON, operation decelerates to a stop and the 20SSC-H enters standby state for the remaining travel distance operation. At this time, "standby for remaining travel distance" flag is turned ON. When the STOP command is OFF and the START command is turned ON during standby status, positioning operation continues for the remaining travel distance.

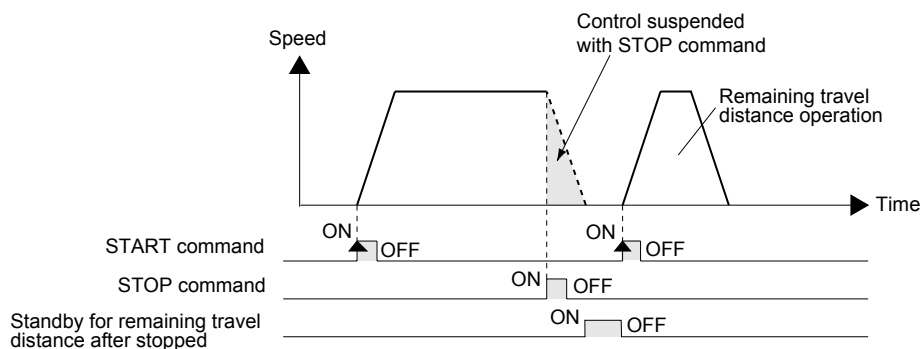

		BFM Number		Data type
		X-axis	Y-axis	
START command	Operation command 1	BFM #518 b9	BFM #618 b9	Control data
STOP command	Operation command 1	BFM #518 b1	BFM #618 b1	Control data
Standby for remaining travel distance at stop	Status information	BFM #28 b7	BFM #128 b7	Monitor data

To cancel the remaining travel distance operation in the remaining travel distance operation mode

When "remaining travel distance operation cancel command" is turned ON in standby status, the operation for the remaining travel distance is cancelled and the positioning operation terminates.

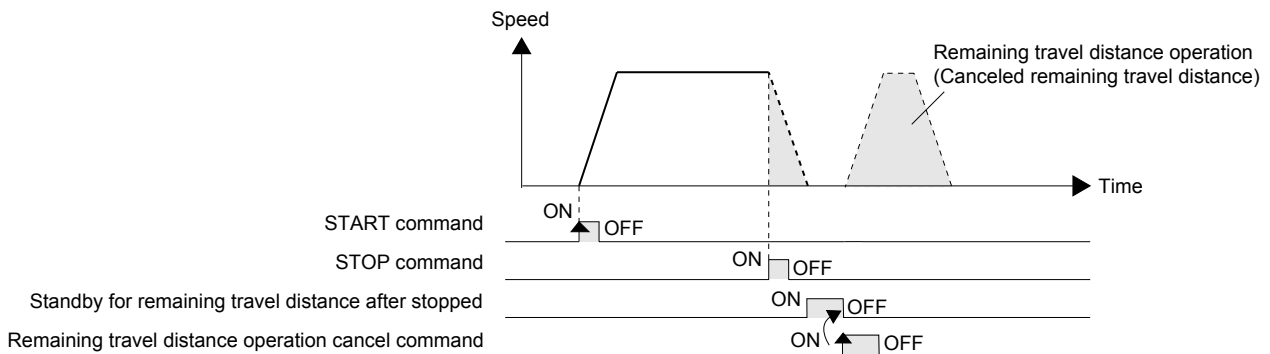

		BFM Number		Data type
		X-axis	Y-axis	
START command	Operation command 1	BFM #518 b9	BFM #618 b9	Control data
STOP command	Operation command 1	BFM #518 b1	BFM #618 b1	Control data
Standby for remaining travel distance at stop	Status information	BFM #28 b7	BFM #128 b7	Monitor data
Remaining distance operation cancel command	Operation command 2	BFM #519 b0	BFM #619 b0	Control data

3. Wiring the stop switch

Connect the stop switch to the input terminal of the PLC.

For details of the PLC wiring method, refer to the following manual according to the PLC being used.

→ Refer to the **FX3U Hardware Edition**

→ Refer to the **FX3uc Hardware Edition**

4. STOP command

Operate the PLC's STOP switch together with the 20SSC-H STOP command.

7.5 Sudden stop selection (Ver.1.20 or later)

This function suddenly stops the work piece when the STOP command/forward rotation limit switch 2 (FLS), reverse rotation limit switch 2 (RLS)/forward rotation limit switch 1 (LSF) or reverse rotation limit switch 1 (LSR)/software limit turns ON during positioning operation.

→ For handling of the forward rotation limit and reverse rotation limit, refer to Section 7.3

→ For the STOP command, refer to Section 7.4

→ For the parameters, control data and monitor data, refer to Chapter 11

1. For specifying the sudden stop operation performed when the STOP command or rotation limit switch turns ON, set the following positioning parameters.

→ For details of positioning parameters, refer to Section 11.1

		BFM Number		Description
		X-axis	Y-axis	
Operation parameter 2	Sudden stop selection (STOP command)	BFM #14002 b4	FM #14202 b4	1 (ON): Sudden stop when the STOP command turns ON 0 (OFF): Normal deceleration stop when the STOP command turns ON
	Sudden stop selection (software limit)	BFM #14002 b5	FM #14202 b5	1 (ON): Sudden stop when the software limit turns ON 0 (OFF): Normal deceleration stop when the software limit turns ON
	Sudden stop selection (PLC limit)	BFM #14002 b6	FM #14202 b6	1 (ON): Sudden stop when the PLC limit turns ON 0 (OFF): Normal deceleration stop when the PLC limit turns ON
	Sudden stop selection (Servo amplifier limit)	BFM #14002 b7	FM #14202 b7	1 (ON): Sudden stop when the Servo amplifier limit (stroke limit) turns ON 0 (OFF): Normal deceleration stop when the Servo amplifier limit (stroke limit) turns ON
Sudden stop deceleration time		BFM #14102	BFM #14302	Set the time to reach 0 speed from the maximum speed for a sudden stop. Setting range: 1 to 5000 ms
Sudden stop interpolation time constant		BFM #14104	BFM #14304	Set the time to reach 0 speed from the operation speed for a sudden stop (interpolation operation). Setting range: 1 to 5000 ms

2. Sudden stop operation

- The work piece suddenly stops after the sudden stop deceleration time (Sudden stop interpolation time constant) when the STOP command or limit switch turns ON during operation. However, the work piece stops after the normal deceleration time when the sudden stop deceleration time (Sudden stop interpolation time constant) is longer than the normal deceleration time (interpolation time constant).

In individual axis operation

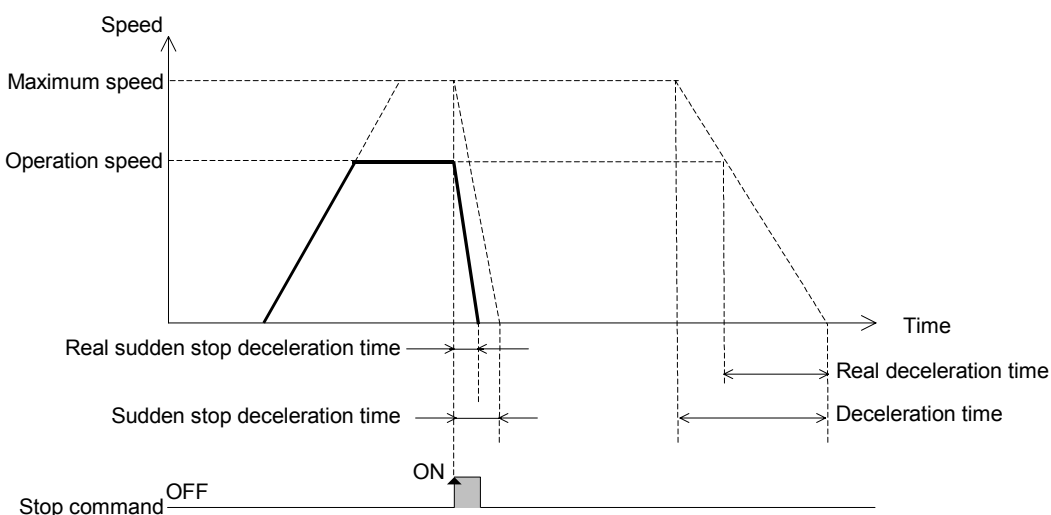

		BFM Number		Data type
		X-axis	Y-axis	
STOP command	Operation command 1	BFM #518 b1	BFM #618 b1	Control data
Forward rotation limit (LSF)	Operation command 1	BFM #518 b2	BFM #618 b2	Control data
Reverse rotation limit (LSR)	Operation command 1	BFM #518 b3	BFM #618 b3	Control data
FLS terminal input	Servo terminal information	BFM #8 b0	BFM #108 b0	Monitor data
RLS terminal input	Servo terminal information	BFM #8 b1	BFM #108 b1	Monitor data
Maximum speed		BFM #14009,#14008	BFM #14209,#14208	Positioning parameters
Operation speed	Operation speed 1	BFM #503,#502	BFM #603,#602	Control data
	Operation speed 2	BFM #507,#506	BFM #607,#606	Control data
	JOG speed	BFM #14013,#14012	BFM #14213,#14212	Positioning parameters
	Zero return speed (high speed)	BFM #14025,#14024	BFM #14225,#14224	Positioning parameters
	Zero return speed (creep)	BFM #14027,#14026	BFM #14227,#14226	Positioning parameters
Acceleration/ deceleration time change command (Ver. 1.30 or later)	Operation command 2	BFM #519 b5	BFM #619 b5	Control data
Deceleration time		BFM #14020	BFM #14220	Positioning parameters
Deceleration time 2 (Ver. 1.30 or later)		BFM #14110	BFM #14310	Positioning parameters
Sudden stop deceleration time		BFM #14102	BFM #14302	Positioning parameters

In simultaneous two-axis operation (interpolation operation)

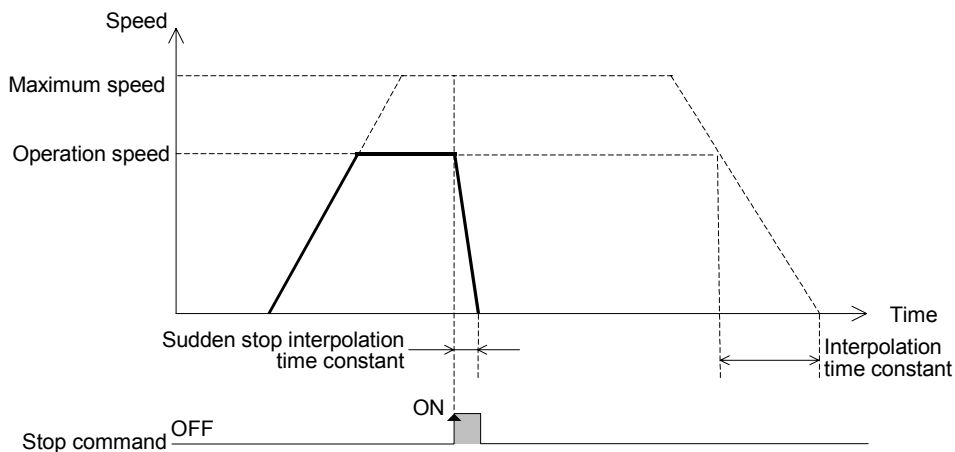

		BFM Number		Data type
		X-axis	Y-axis	
STOP command	Operation command 1	BFM #518 b1	BFM #618 b1 ^{*1}	Control data
Forward rotation limit (LSF)	Operation command 1	BFM #518 b2	BFM #618 b2	Control data
Reverse rotation limit (LSR)	Operation command 1	BFM #518 b3	BFM #618 b3	Control data
FLS terminal input	Servo terminal information	BFM #8 b0	BFM #108 b0	Monitor data
RLS terminal input	Servo terminal information	BFM #8 b1	BFM #108 b1	Monitor data
Maximum speed		BFM #14009,#14008	BFM #14209,#14208 ^{*1}	Positioning parameters
Operation speed	Operation speed 1	BFM #503,#502	BFM #603,#602 ^{*1}	Control data
	Operation speed 2	BFM #507,#506	BFM #607,#606 ^{*1}	Control data
Interpolation time constant		BFM #14022	BFM #14222 ^{*1}	Positioning parameters
Sudden stop interpolation time constant		BFM #14104	BFM #14304 ^{*1}	Positioning parameters

*1. Shaded columns are invalid for interpolation operation.

- 2) When the STOP command or rotation limit switch turns ON during deceleration stop, the servo motor suddenly stops in accordance with the sudden stop deceleration time (sudden stop interpolation time constant).

In individual axis operation

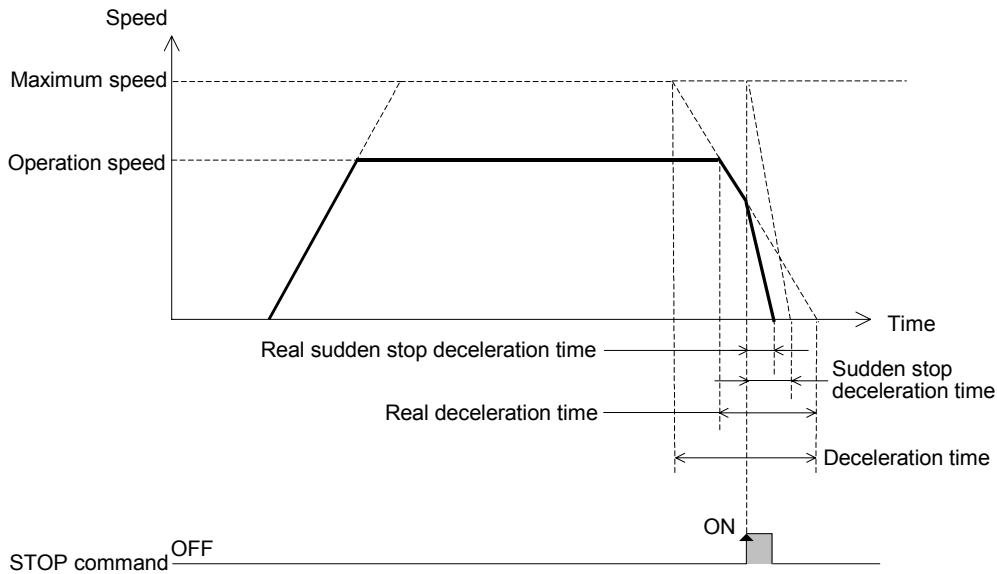

		BFM Number		Data type
		X-axis	Y-axis	
STOP command	Operation command 1	BFM #518 b1	BFM #618 b1	Control data
Forward rotation limit (LSF)	Operation command 1	BFM #518 b2	BFM #618 b2	Control data
Reverse rotation limit (LSR)	Operation command 1	BFM #518 b3	BFM #618 b3	Control data
FLS terminal input	Servo terminal information	BFM #8 b0	BFM #108 b0	Monitor data
RLS terminal input	Servo terminal information	BFM #8 b1	BFM #108 b1	Monitor data
Maximum speed		BFM #14009,#14008	BFM #14209,#14208	Positioning parameters
Operation speed	Operation speed 1	BFM #503,#502	BFM #603,#602	Control data
	Operation speed 2	BFM #507,#506	BFM #607,#606	Control data
	JOG speed	BFM #14013,#14012	BFM #14213,#14212	Positioning parameters
	Zero return speed (high speed)	BFM #14025,#14024	BFM #14225,#14224	Positioning parameters
	Zero return speed (creep)	BFM #14027,#14026	BFM #14227,#14226	Positioning parameters
Acceleration/ deceleration time change command (Ver. 1.30 or later)	Operation command 2	BFM #519 b5	BFM #619 b5	Control data
Deceleration time		BFM #14020	BFM #14220	Positioning parameters
Deceleration time 2 (Ver. 1.30 or later)		BFM #14110	BFM #14310	Positioning parameters
Sudden stop deceleration time		BFM #14102	BFM #14302	Positioning parameters

In simultaneous two-axis operation (interpolation operation)

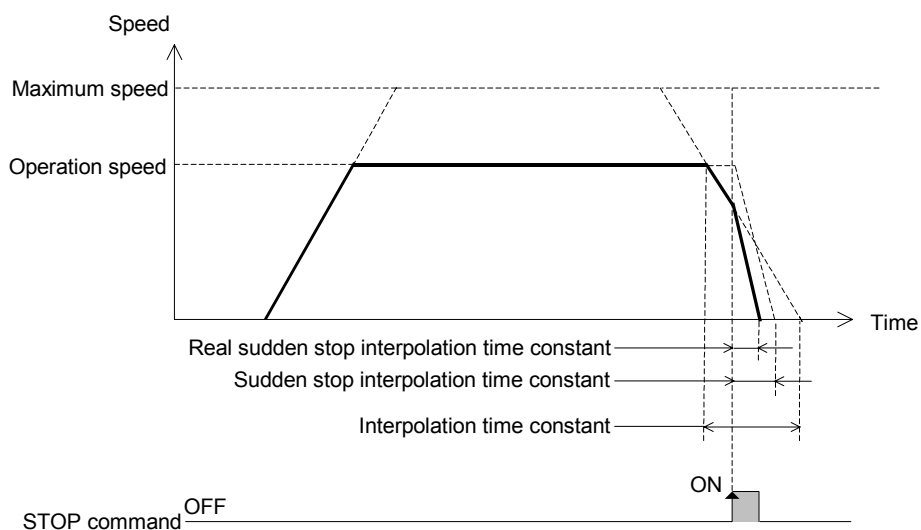

		BFM Number		Data type
		X-axis	Y-axis	
STOP command	Operation command 1	BFM #518 b1	BFM #618 b1 ^{*1}	Control data
Forward rotation limit (LSF)	Operation command 1	BFM #518 b2	BFM #618 b2	Control data
Reverse rotation limit (LSR)	Operation command 1	BFM #518 b3	BFM #618 b3	Control data
FLS terminal input	Servo terminal information	BFM #8 b0	BFM #108 b0	Monitor data
RLS terminal input	Servo terminal information	BFM #8 b1	BFM #108 b1	Monitor data
Maximum speed		BFM #14009,#14008	BFM #14209,#14208 ^{*1}	Positioning parameters
Operation speed	Operation speed 1	BFM #503,#502	BFM #603,#602 ^{*1}	Control data
	Operation speed 2	BFM #507,#506	BFM #607,#606 ^{*1}	Control data
Interpolation time constant		BFM #14022	BFM #14222 ^{*1}	Positioning parameters
Sudden stop interpolation time constant		BFM #14104	BFM #14304 ^{*1}	Positioning parameters

*1. Shaded columns are invalid for interpolation operation.

7.6 Changing During Operation (Operation Speed, Target Address)

7.6.1 Changing the operation speed with the override function

This function changes the operation speed during positioning operation based on a ratio. Specify the operation speed change ratio using the override setting (0.1 to 3000.0%). When changing the operation speed using the override function, it is not necessary to control the "change command in operation disabled" flag (b12) in the operation command 1 (X-axis: BFM #518, Y-axis: BFM #618).

→ For the parameters, control data and monitor data, refer to Chapter 11

1. When using the override function, set the following override setting to the ratio corresponding to the operation speed.

	BFM Number		Description
	X-axis	Y-axis	
Override setting	BFM #508	BFM #608	Setting range: 1 to 30000(× 0.1%)

2. Applicable positioning operations

- Operations applicable to the override function
 - Mechanical zero return (at high speed)
 - JOG operation
 - 1-speed positioning operation
 - Interrupt 1-speed constant quantity feed
 - 2-speed positioning operation
 - Interrupt 2-speed constant quantity feed
 - Interrupt stop
 - Variable speed operation
 - Multi-speed operation
 - Linear interpolation
 - Linear interpolation (interrupt stop)
 - Circular interpolation
 - Reciprocal movement instruction (Ver.1.10 or later)
- Operations inapplicable to the override function
 - Mechanical zero return (at creep)
 - Manual pulse generator operation

3. Operation

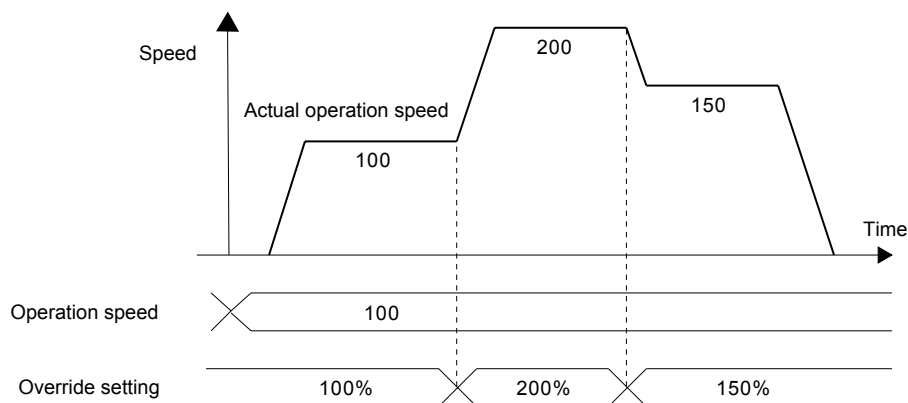

		BFM Number		Data type
		X-axis	Y-axis	
Operation speed setting	Operation speed 1	BFM #503,#502	BFM #603,#602	Control data
	Operation speed 2	BFM #507,#506	BFM #607,#606	Control data
	JOG speed	BFM #14013,#14012	BFM #14213,#14212	Positioning parameters
	Zero return speed (high speed)	BFM #14025,#14024	BFM #14225,#14224	Positioning parameters
Operation speed present value		BFM #11,#10	BFM #111,#110	Monitor data
Override setting		BFM #508	BFM #608	Control data

- 1 Introduction
- 2 System configuration
- 3 Specifications
- 4 Installation
- 5 Wiring
- 6 Memory Config and data operation
- 7 Before starting positioning operation
- 8 Manual control
- 9 Positioning Control
- 10 Table Operation

Caution for speed change

- If the overridden (actual) operation speed is smaller than 1, the operation speed is handled as "1" in the current speed unit.
- When "100%" is set to the override setting, the system operates at the preset operation speed.
- The operation speed can be changed during positioning operation.
 The override function is invalid during deceleration after a STOP command or in positioning operation.
- When the operation speed is changed by the override function during interpolation operation, the acceleration/deceleration time (interpolation time constant) changes according to the ratio by which the operation speed changes.

→ For details, refer to the note in Section 7.2

4. Program description example

In the program below, the operation speed is changed as follows.

Contents of change		
X035=ON	X-axis	Changes the operation speed to "200.0%."
	Y-axis	Changes the operation speed to "200.0%."
X035=OFF	X-axis	Changes the operation speed to "100.0%."
	Y-axis	Changes the operation speed to "100.0%."

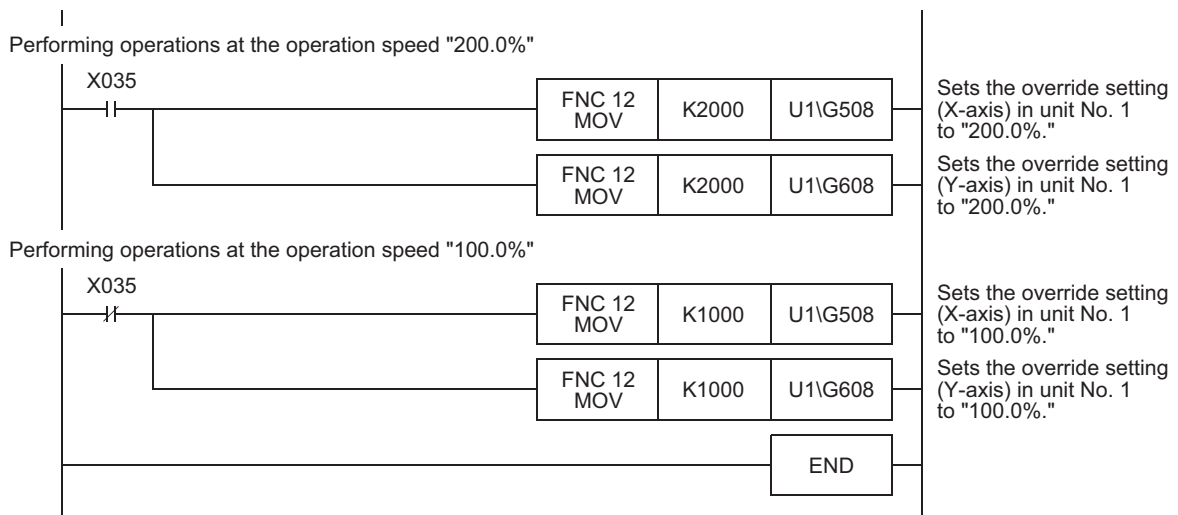

7.6.2 Changing the operation speed with the operation speed change function

This function is possible to change to the specified new operation speed at an arbitrary timing. However, the speed does not change during mechanical zero return after detection of the near point DOG and start of deceleration to the creep speed.
→ For the parameters, control data and monitor data, refer to Chapter 11

1. Set as follows when changing the operation speed using the operation speed change function.

		BFM Number		Description
		X-axis	Y-axis	
Operation command 1	Change command in operation disabled	BFM #518 b12	BFM #618 b12	Set these bits to OFF. While these bits are ON, the speed change command in positioning operation and target position change command in positioning operation are disabled.
	Speed change command in positioning operation	BFM #518 b13	BFM #618 b13	Set these bits to ON from OFF. When these bits are set to ON from OFF, the speed in the positioning operation is changed to the speed set by the speed change value.
Speed change value		BFM #513, #512	BFM #613, #612	Setting range: 1 to 2,147,483,647 [User unit]*1 Set the value within 1 to 50,000,000 Hz in converted pulse data.

*1. Refer to the section shown below for details on the user unit.

→ Refer to Section 7.10

2. Applicable positioning operations

- Operations applicable to the operation speed change function
 - Mechanical zero return (at high speed)
 - JOG operation
 - 1-speed positioning operation
 - Interrupt 1-speed quantity feed
 - 2-speed positioning operation
 - Interrupt 2-speed quantity feed
 - Interrupt stop
 - Multi-speed operation
 - Linear interpolation
 - Linear interpolation (interrupt stop)
 - Circular interpolation
 - Reciprocal movement instruction (Ver.1.10 or later)
- Operations inapplicable to the operation speed change function
 - Mechanical zero return (at creep)
 - Manual pulse generator operation
 - Variable speed operation

3. Operation

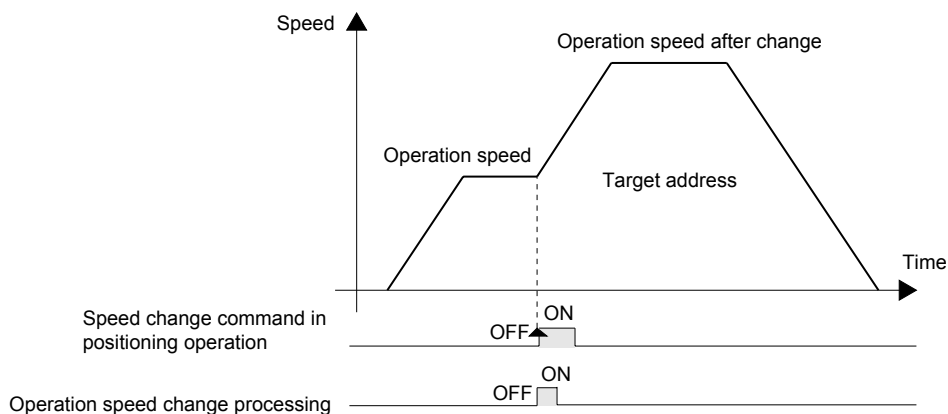

- 1 Introduction
- 2 System configuration
- 3 Specifications
- 4 Installation
- 5 Wiring
- 6 Memory Config. and data operation
- 7 Before starting positioning operation
- 8 Manual control
- 9 Positioning Control
- 10 Table Operation

		BFM Number		Data type
		X-axis	Y-axis	
Operation speed setting	Operation speed 1	BFM #503,#502	BFM #603,#602	Control data
	Operation speed 2	BFM #507,#506	BFM #607,#606	Control data
	JOG speed	BFM #14013,#14012	BFM #14213,#14212	Positioning parameters
	Zero return speed (high speed)	BFM #14025,#14024	BFM #14225,#14224	Positioning parameters
Operation speed present value		BFM #11,#10	BFM #111,#110	Monitor data
Change command in operation disabled	Operation command 1	BFM #518 b12	BFM #618 b12	Control data
Speed change command in positioning operation	Operation command 1	BFM #518 b13	BFM #618 b13	Control data
Speed change value		BFM #513,#512	BFM #613,#612	Control data
During operation speed change	Status information	BFM #28 b13	BFM #128 b13	Monitor data
Received target speed (Ver.1.20 or later)		BFM #27,#26	BFM #127,#126	Monitor data

Change procedure

- 1) Set the following bits to OFF in operation command 1.
 - Change command in operation disabled
 - Speed change command in positioning operation
- 2) Set the speed change value.
- 3) Set the speed change command in positioning operation to ON in operation command 1.
- 4) Set the following bits in operation command 1 as follows when the received target speed is equal to the speed change value.
 - Set the speed change command in positioning operation to OFF.
 - Set the Change command in operation disabled flag to ON.
 When unintended speed changes during operation are disabled except changes by change commands (excluding speed changes using the override function)

4. Cautions for speed change

- When the Operation Speed Change function has been used along with the Remaining Travel Distance operation mode, if STOP command is turned ON during positioning operation, the next operation speed is defined by the changed speed.
- The operation speed can not change in the following statuses.
 - When operation is started (that is, when the START command or START input is given)
 At the start of operation, change the setting of operation speed 1, operation speed 2, jog speed^{*1} and zero return speed (high speed)^{*1} before giving the START input (or command).
- *1. For the jog speed and zero return speed (high speed), change the positioning parameters.
 → **For update of positioning parameters, refer to Subsection 7.1.7**
 - During deceleration by STOP command
 - During automatic deceleration in position control
- If an operation speed larger than the maximum speed is specified for the speed change value, a setting error occurs and the operation speed is controlled at the maximum speed.
- To change the speed at interpolation control, the speed change value has to be set in the X-axis setting.
- The operation speed does not change during mechanical zero return (at creep). The speed change command is ignored.

5. Program description example

In the following program, the operation speed is changed as follows.

Contents of change	
X-axis	Changes the operation speed to 2,000,000.
Y-axis	Changes the operation speed to 2,000,000.

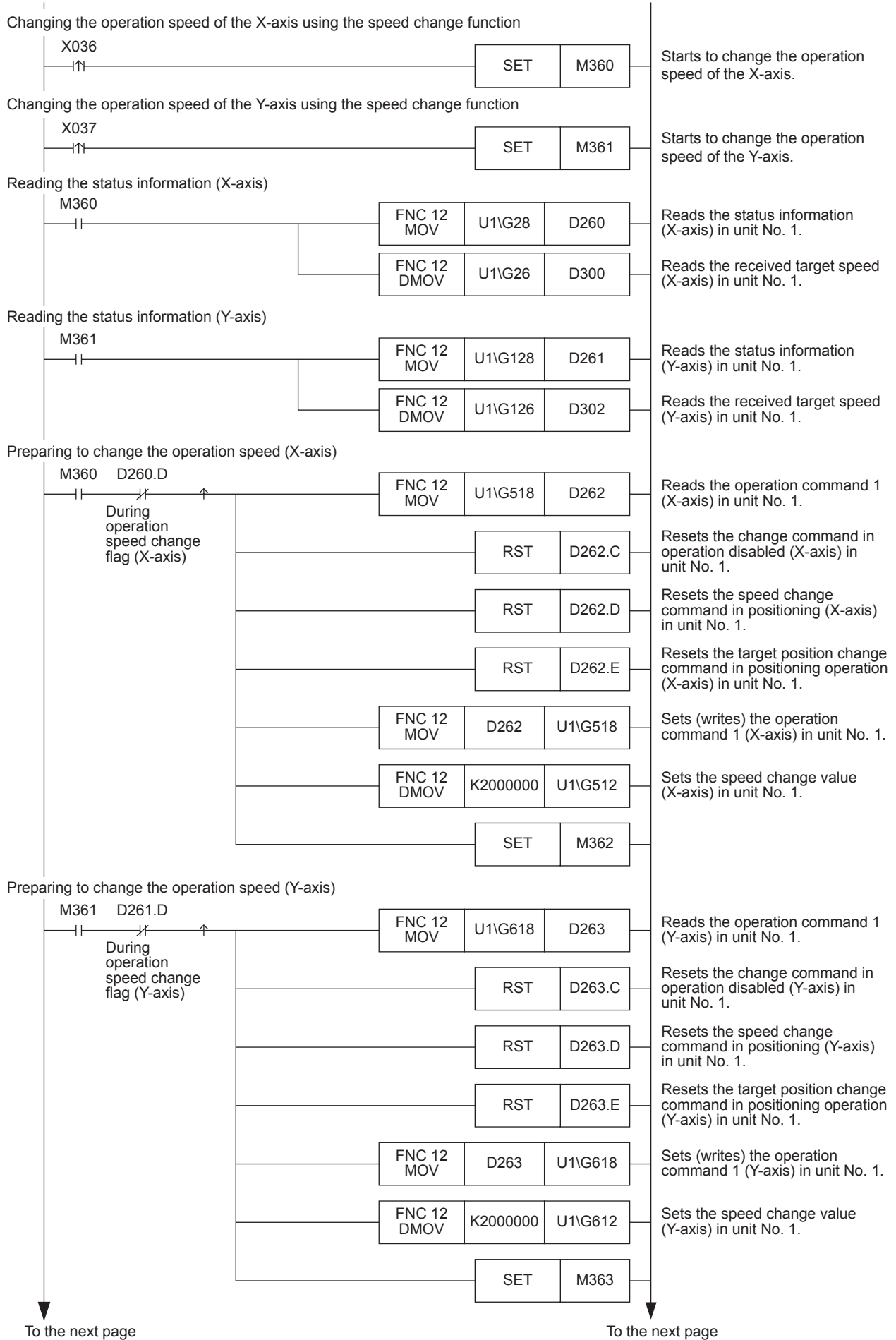

1	Introduction
2	System configuration
3	Specifications
4	Installation
5	Wiring
6	Memory Config and data operation
7	Before starting positioning operation
8	Manual control
9	Positioning Control
10	Table Operation

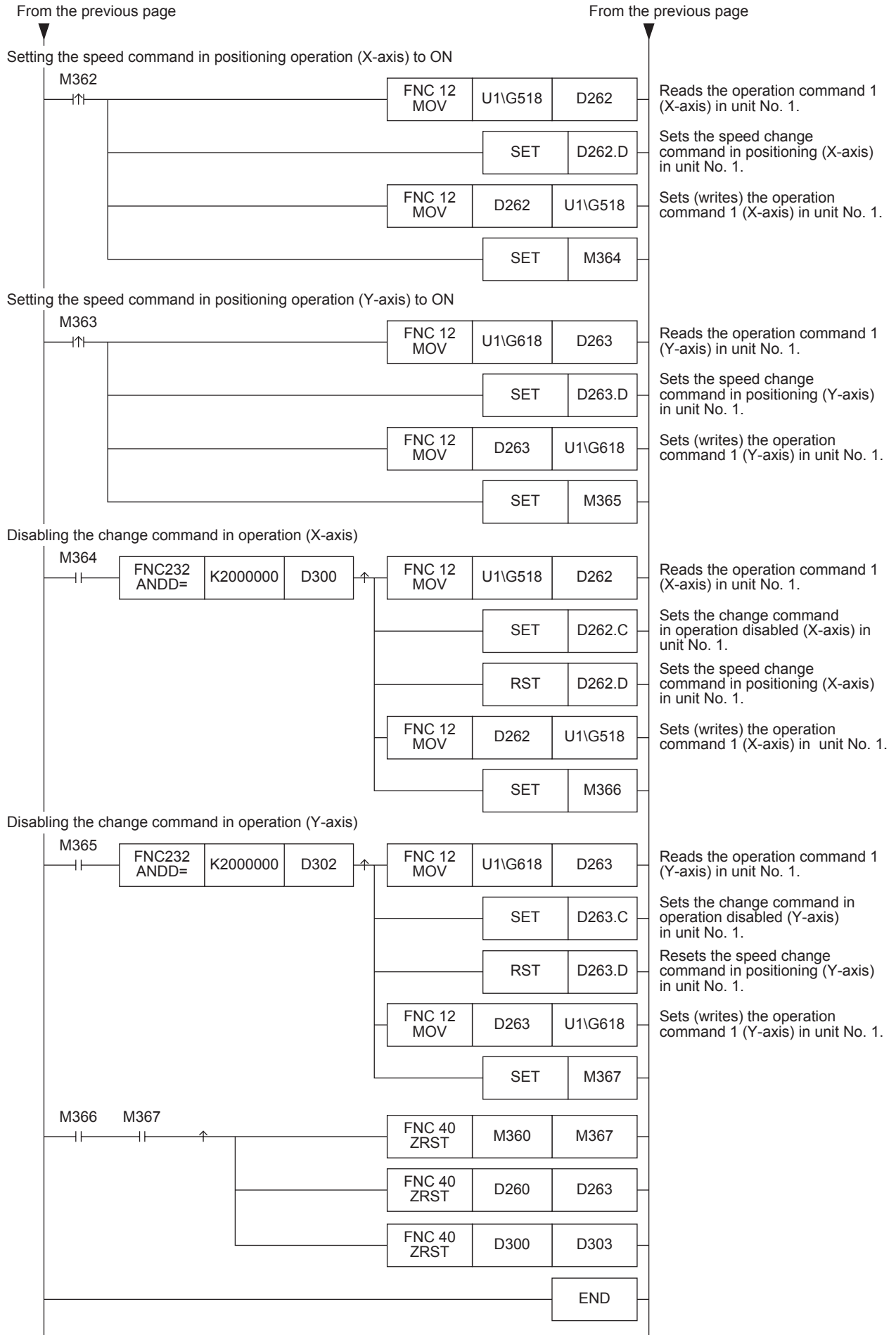

7.6.3 Changing target address during operation using target address change function

This function is used to change the target address in positioning control to a new specified address.

→ For the parameters, control data and monitor data, refer to Chapter 11

1. Set the following when changing the target address and operation speed during operation using the target address change function.

		BFM Number		Description
		X-axis	Y-axis	
Operation command 1	Change command in operation disabled	BFM #518 b12	BFM #618 b12	Set these bits to OFF. While these bits are ON, the speed change command in positioning operation and target position change command is disabled.
	Target position change command in positioning operation	BFM #518 b14	BFM #618 b14	Set these bits to ON from OFF. When these bits are set to ON from OFF, the target address during operation is changed to the address and speed set in the target position change value (address) and target position change value (speed).
Target position change value (address)		BFM #515, #514	BFM #615, #614	Setting range: -2,147,483,648 to 2,147,483,647 [User unit] ^{*1} Set the value within -2,147,483,648 to 2,147,483,647 PLS in converted pulse data.
Target position change value (speed)		BFM #517, #516	BFM #617, #616	Setting range: 1 to 2,147,483,647 [User unit] ^{*1} Set the value within 1 to 50,000,000 Hz in converted pulse data.

*1. Refer to the section shown below for details on the user units.

→ Refer to Section 7.10

Note

To leave the operation speed unchanged, set the target position change value (speed) to the same speed as the current operation speed.

2. Applicable positioning operations

- Operations applicable to the target address change function
 - 1-speed positioning operation
 - Interrupt 1-speed constant quantity feed
 - 2-speed positioning operation
 - Interrupt 2-speed constant quantity feed
 - Interrupt stop
 - Reciprocal movement instruction (Ver.1.10 or later)
- Operations inapplicable to the target address change function
 - Mechanical zero return
 - Manual pulse generator operation
 - JOG operation
 - Variable speed operation
 - Multi-speed operation
 - Linear interpolation
 - Linear interpolation (interrupt stop)
 - Circular interpolation

3. Operation

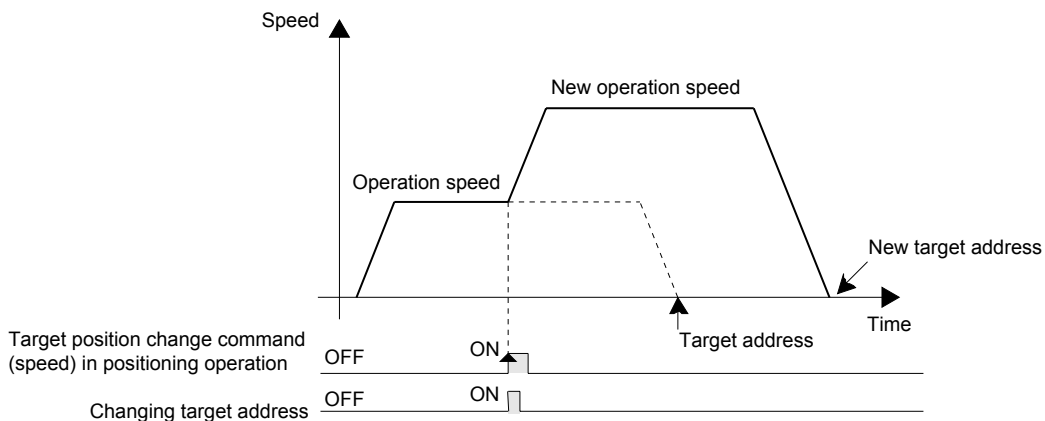

		BFM Number		Data type
		X-axis	Y-axis	
Operation speed setting	Operation speed 1	BFM #503,#502	BFM #603,#602	Control data
	Operation speed 2	BFM #507,#506	BFM #607,#606	Control data

- 1 Introduction
- 2 System configuration
- 3 Specifications
- 4 Installation
- 5 Wiring
- 6 Memory Config. and data operation
- 7 Before starting positioning operation
- 8 Manual control
- 9 Positioning Control
- 10 Table Operation

		BFM Number		Data type
		X-axis	Y-axis	
Operation speed present value		BFM #11,#10	BFM #111,#110	Monitor data
Change command in operation disabled	Operation command 1	BFM #518 b12	BFM #618 b12	Control data
	Operation command 1	BFM #518 b14	BFM #618 b14	Control data
Target position change command in positioning operation		BFM #501,#500	BFM #601,#600	Control data
Target address	Target address 1	BFM #505,#504	BFM #605,#604	Control data
	Target address 2	BFM #515,#514	BFM #615,#614	Control data
Target position change value (address)		BFM #517,#516	BFM #617,#616	Control data
Target position change value (speed)		BFM #25,#24	BFM #125,#124	Monitor data
Received target address (Ver.1.20 or later)		BFM #27,#26	BFM #127,#126	Monitor data
During target address change	Status information	BFM #28 b14	BFM #128 b14	Monitor data

Change procedure

- 1) Set the following bits to OFF in operation command 1.
 - Change command in operation disabled
 - Target position change command in positioning operation
- 2) Set the target position change value (address) and target position change value (speed).
- 3) Set the target position change command in positioning operation to ON in operation command 1.
- 4) Set the following bits in operation command 1 as follows when the received target address is equal to the target position change value (address) and the received target speed is equal to the target position change value (speed).
 - Set the target position change command in positioning operation to OFF.
 - Set the change command in operation disabled to ON.
 When unintended speed changes during operation are disabled except changes by change commands (excluding speed changes using the override function)

Operation when the operation direction changes

When the operation direction changes due to a change of the target address, the system will decelerate and stop, turn around, and then reach the newly set address.

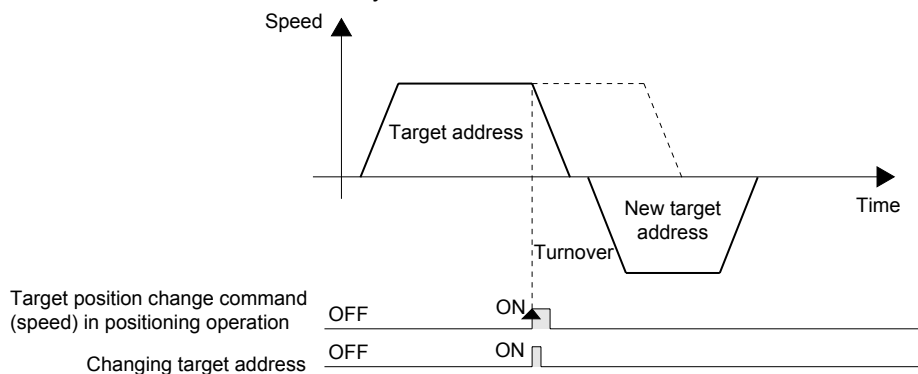

4. Cautions

- The operation speed can not change in the following statuses.
 - When operation is started (that is, when the START command or START input is given)
At the start of operation, change the setting of target address 1, target address 2 and, operation speed 1 and operation speed 2 before giving the START input (or command).
 - During deceleration by STOP command
 - During automatic deceleration in position control
 - If the target position change value (address) converted in units of pulses is out of the setting range, an error occurs.
 - If the target position change value (speed) is out of the setting range, the operation speed is handled as "1"(lower limit) or maximum speed (upper limit).
 - If the specified target address requires change of the operation direction after the interrupt input changes from OFF to ON during the following operation, the work piece moves to the address where the interrupt input turned ON and stops there:
 - Interrupt 1-speed Constant Quantity Feed*1
 - Interrupt 2-speed Constant Quantity Feed
- *1. However, the operation is different in the constant position stop mode.
→ Refer to Subsection 9.3.2
- The following target address changes are not allowed during 2-speed positioning operation:
 - Target address change that requires change of the operation direction at the 1st speed during 1st speed operation
 - Target address change that requires change of the target address at the 2nd speed during 1st speed operation.

5. Program description example

In the following program, the operation speed and target address are changed as follows.

Contents of change		
Operation speed	X-axis	Changes the operation speed to 2,000,000.
	Y-axis	Changes the operation speed to 2,000,000.
Target address	X-axis	Changes the target address to 5,000,000.
	Y-axis	Changes the target address to 5,000,000.

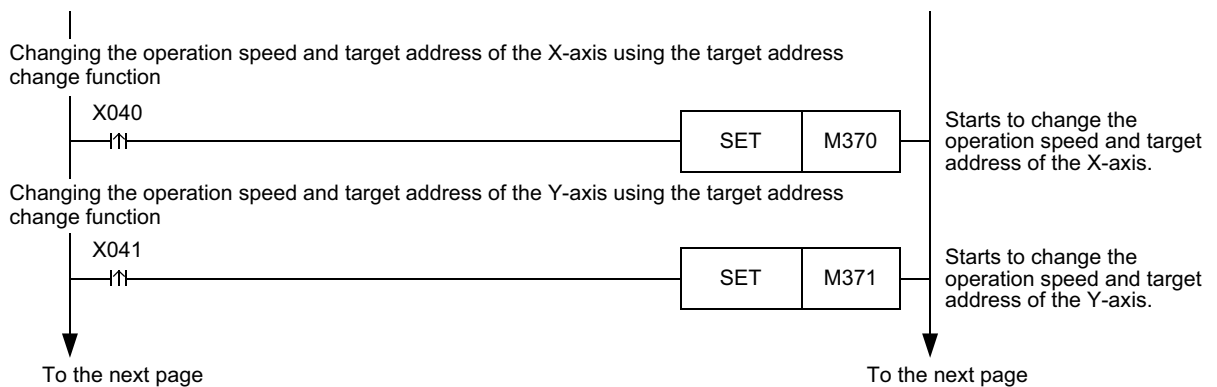

1 Introduction

2 System configuration

3 Specifications

4 Installation

5 Wiring

6 Memory Config and data operation

7 Before starting positioning operation

8 Manual control

9 Positioning Control

10 Table Operation

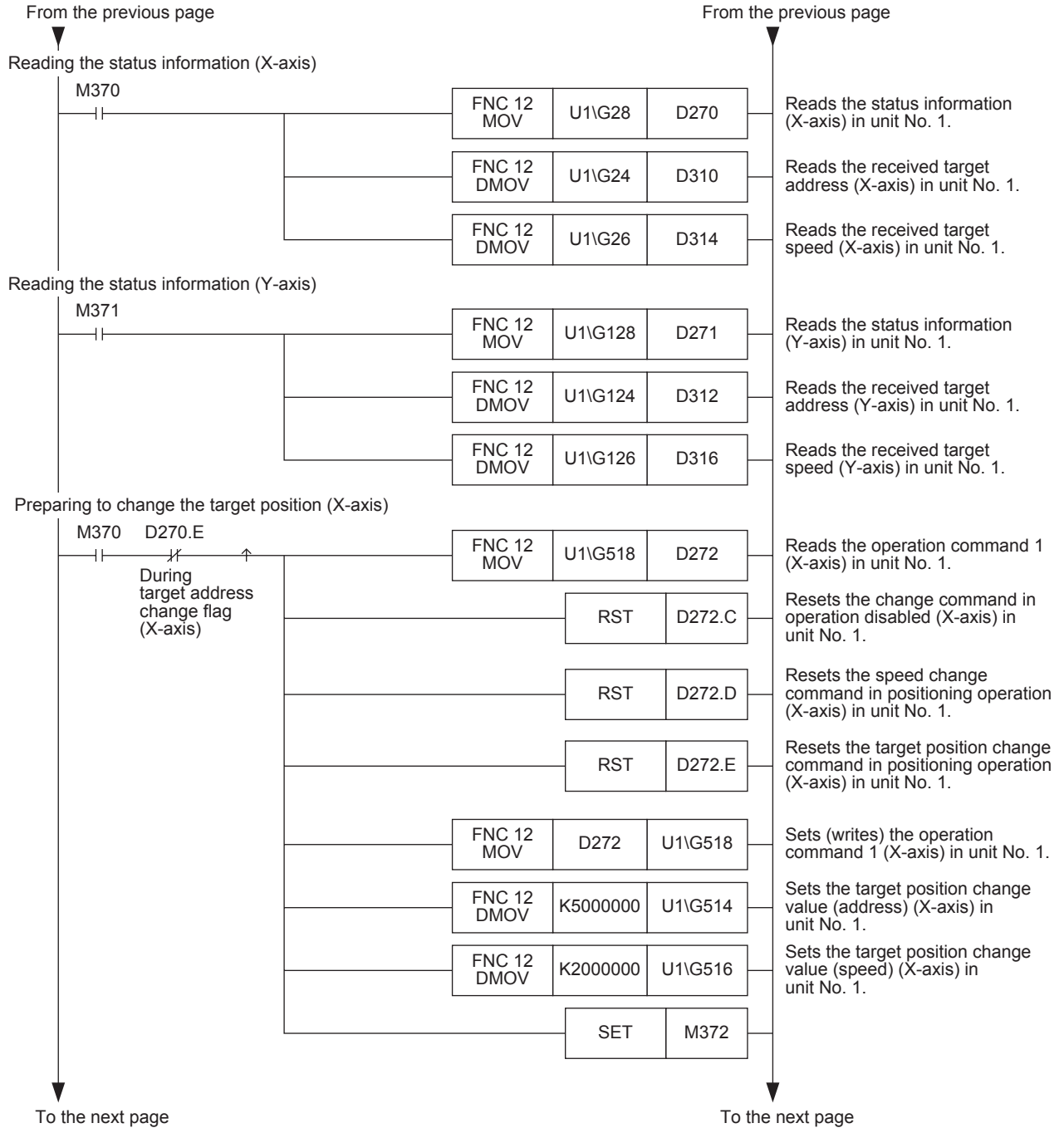

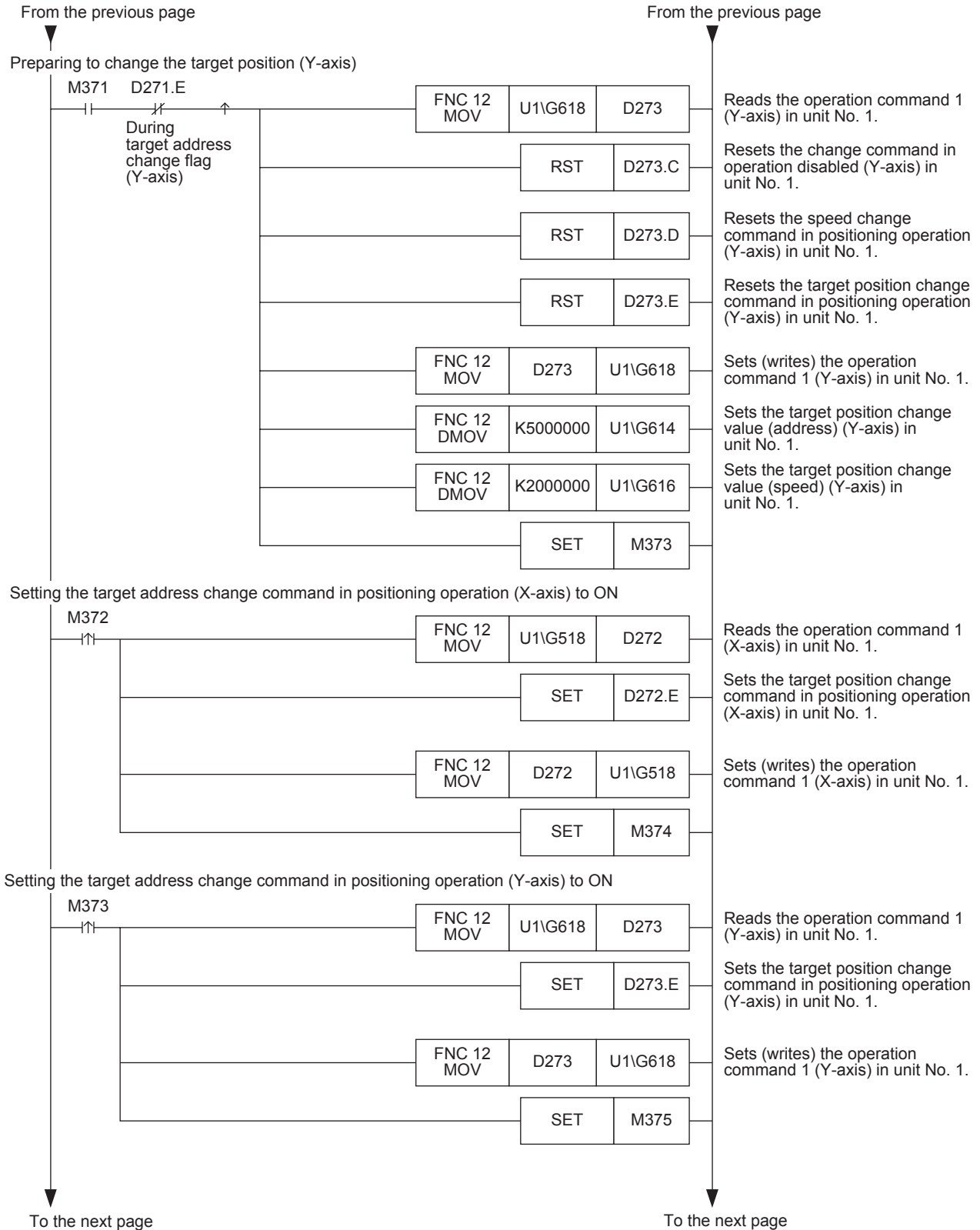

- 1 Introduction
- 2 System configuration
- 3 Specifications
- 4 Installation
- 5 Wiring
- 6 Memory Config. and data operation
- 7 Before starting positioning operation
- 8 Manual control
- 9 Positioning Control
- 10 Table Operation

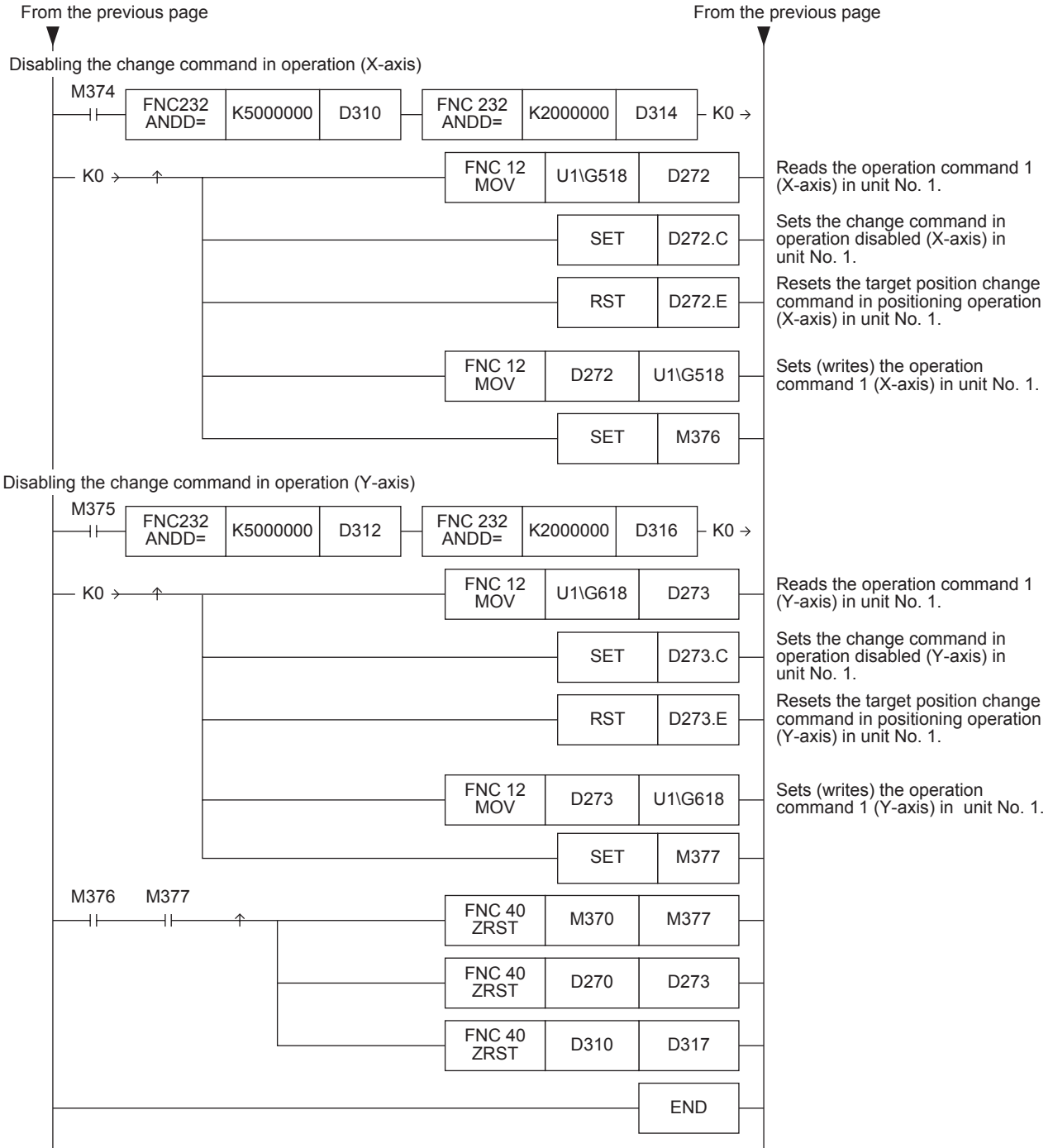

7.7 Acceleration/deceleration time selection (Ver. 1.30 or later)

Select the acceleration/deceleration time used in positioning operation except interpolation operation.
Select the acceleration/deceleration time before starting positioning operation.

→ For parameters, control data and monitor data, refer to Chapter 11

1. Select the acceleration/deceleration time used in positioning operation using the acceleration/deceleration time change command.

	BFM Number		Description
	X-axis	Y-axis	
Acceleration/deceleration time change command (Ver. 1.30 or later) [Operation command 2]	BFM #519 b5	BFM #619 b5	Select the acceleration/deceleration time used for acceleration/deceleration. However, the acceleration/deceleration time during interpolation operation is determined by the interpolation time constant. OFF: The system will perform positioning operation using the acceleration time and deceleration time. ON: The system will perform positioning operation using the acceleration time 2 and deceleration time 2.
Acceleration time	BFM #14018	BFM #14218	
Acceleration time 2 (Ver. 1.30 or later)	BFM #14108	BFM #14308	Time required to achieve the maximum speed from speed 0
Deceleration time	BFM #14020	BFM #14220	
Deceleration time 2 (Ver. 1.30 or later)	BFM #14110	BFM #14310	Time required to achieve speed 0 from the maximum speed

2. Applicable positioning operations

- Operations for which the acceleration/deceleration time change command is enabled
 - Mechanical zero return operation (creep)
 - Mechanical zero return operation (high speed)
 - Jog operation (except inching operation)
 - 1-speed positioning operation
 - Interrupt 1-speed constant quantity feed
 - 2-speed positioning operation
 - Interrupt 2-speed constant quantity feed
 - Variable speed operation
 - Multi-speed operation
 - Reciprocal movement instruction (Ver. 1.10 or later)
- Operations for which the acceleration/deceleration time change command is disabled
 - Jog operation (during inching operation)
 - Manual pulse generator operation
 - Linear interpolation
 - Linear interpolation (interrupt stop)
 - Circular interpolation

3. Operation

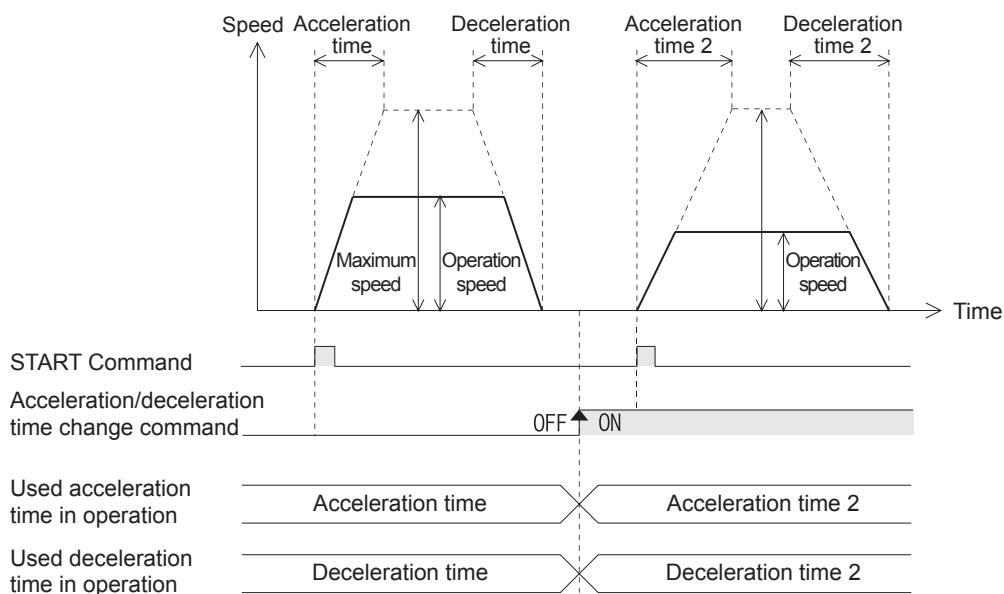

- 1 Introduction
- 2 System configuration
- 3 Specifications
- 4 Installation
- 5 Wiring
- 6 Memory Config. and data operation
- 7 Before starting positioning operation
- 8 Manual control
- 9 Positioning Control
- 10 Table Operation

		BFM Number		Data type
		X-axis	Y-axis	
Acceleration/deceleration time change command (Ver. 1.30 or later)	Operation command 2	BFM #519 b5	BFM #619 b5	Control data
Maximum speed		BFM #14009,#14008	BFM #14209,#14208	Positioning parameters
Acceleration time		BFM #14018	BFM #14218	Positioning parameters
Deceleration time		BFM #14020	BFM #14220	Positioning parameters
Acceleration time 2 (Ver. 1.30 or later)		BFM #14108	BFM #14308	Positioning parameters
Deceleration time 2 (Ver. 1.30 or later)		BFM #14110	BFM #14310	Positioning parameters

Note

- Enable the acceleration/deceleration time setting before starting positioning operation.
→ **For the method to enable changed positioning parameters, refer to Subsection 7.1.7**
- Do not change the status of the acceleration/deceleration time change command during positioning operation.
Select the acceleration /deceleration time before starting positioning operation.
If the acceleration/deceleration time selection is changed during positioning operation, the system will perform the following operation depending on the operation status:
 - When the acceleration/deceleration time selection is changed during acceleration/deceleration
The system will operate using the new acceleration/deceleration time. However, attention should be paid to positioning operation because the acceleration time setting may not be changed with the intended timing.
 - When the acceleration/deceleration time selection is changed during positioning operation at operation speed
The system will operate using the new deceleration time. If the acceleration/deceleration time selection is changed just before start of deceleration, the deceleration time setting may not be changed.
If the time needed for the remaining travel distance is shorter than the time needed for deceleration after a change, the pulse output may decrease suddenly during deceleration.
For 2-speed positioning operation, interrupt 2-speed constant quantity feed, variable speed operation and multi-speed operation, the system will operate using the new acceleration/deceleration time.
 - When the acceleration/deceleration time selection is changed during deceleration
The system will operate using the deceleration time before the change.
However, for 2-speed positioning operation, interrupt 2-speed constant quantity feed, variable speed operation and multi-speed operation, the system will operate using the changed acceleration/ deceleration time.

4. Program description example

In following the program, the acceleration/deceleration time setting is changed as follows.

Contents of change	
X042=ON	Selects the acceleration time 2 and deceleration time 2 for the acceleration/deceleration time of the X-axis.
X042=OFF	Selects the acceleration time and deceleration time for the acceleration/deceleration time of the X-axis.
X043=ON	Selects the acceleration time 2 and deceleration time 2 for the acceleration/deceleration time of the Y-axis.
X043=OFF	Selects the acceleration time and deceleration time for the acceleration/deceleration time of the Y-axis.

Selects the acceleration time 2 and deceleration time 2 for the acceleration/deceleration time of X-axis.

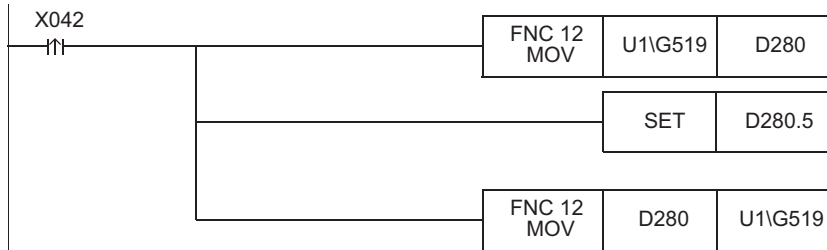

Reads operation command 2 (X-Axis) in unit No.1.
Sets the acceleration/ deceleration time change command (X-axis) in unit No.1.
Sets (writes) operation command 2 (X-axis) in unit No.1.

Selects the acceleration time and deceleration time for the acceleration/deceleration time of X-axis.

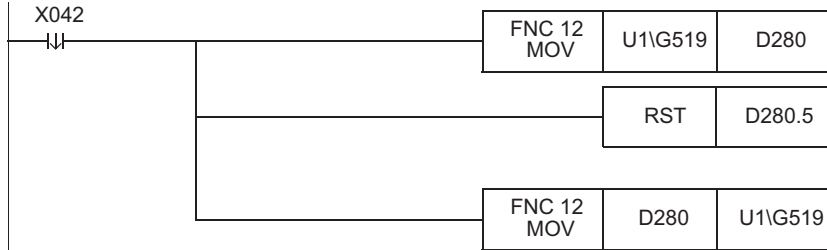

Reads operation command 2 (X-Axis) in unit No.1.
Resets the acceleration/ deceleration time change command (X-axis) in unit No.1.
Sets (writes) operation command 2 (X-axis) in unit No.1.

Selects the acceleration time 2 and deceleration time 2 for the acceleration/deceleration time of Y-axis.

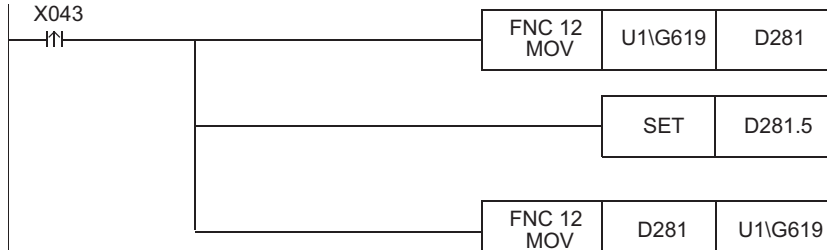

Reads operation command 2 (Y-Axis) in unit No.1.
Sets the acceleration/ deceleration time change command (Y-axis) in unit No.1.
Sets (writes) operation command 2 (Y-axis) in unit No.1.

Selects the acceleration time and deceleration time for the acceleration/deceleration time of Y-axis.

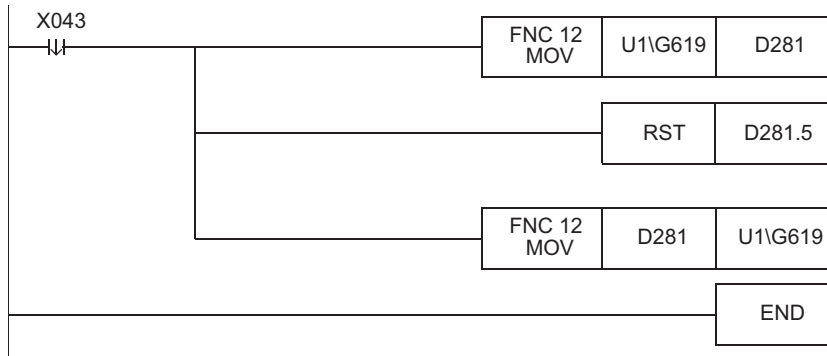

Reads operation command 2 (Y-Axis) in unit No.1.
Resets the acceleration/ deceleration time change command (Y-axis) in unit No.1.
Sets (writes) operation command 2 (Y-axis) in unit No.1.

1	Introduction
2	System configuration
3	Specifications
4	Installation
5	Wiring
6	Memory Config and data operation
7	Before starting positioning operation
8	Manual control
9	Positioning Control
10	Table Operation

7.8 Ring counter setting (Ver.1.10 or later)

This function causes the current address to perform the ring operation within the range from 0 to the preset ring counter upper limit value.

The current address (user) performs the ring operation within the range from 0 to the preset ring value. The current address (pulse) performs the ring operation within the range from 0 to the preset ring value converted into pulses.

The 20SSC-H Ver. 1.30 or later supports unlimited length feed in ring operation when the absolute position detection system is used.

No setting is necessary for unlimited length feed.

However, the reciprocal movement instruction does not support unlimited length feed in ring operation when the absolute position detection system is used.

→ For parameters, control data and monitor data, refer to Chapter 11

Caution

When the absolute current position from the zero-point exceeds the range of 32 bit data (-2,147,483,648 to 2,147,483,647), the current value overflow flag in the status information is ON.

Since 20SSC-H units earlier than Ver.1.30 do not support unlimited length feed in "ring operation" when the absolute position detection system is used, an error (error code: 3004) occurs at the next power startup in this case.

1. Set the following for enabling ring operation in the current address.

		BFM Number		Description
		X-axis	Y-axis	
Operation parameter 2	Ring counter setting	BFM #14002 b3	BFM #14202 b3	Set these bits to ON for enabling ring operation in the current address. 1 (ON): Enables ring operation in the current address. 0 (OFF): Disables ring operation in the current address.
Mechanical zero-point address		BFM #14029, #14028	BFM #14229, #14228	When enabling ring operation, set the zero-point address within the range from 0 to the ring value.
Ring counter upper limit value		BFM #14101, #14100	BFM #14301, #14300	Sets the ring value to enable ring operation. Setting range : 1 to 359,999,999 (user unit) ^{*1} Set the value within 1 to 359,999,999 PLS in converted pulse data.
Target address 1		BFM #501, #500	BFM #601, #600	Setting range: -2,147,483,648 to 2,147,483,647 [User unit] ^{*1} Set the value within -2,147,483,648 to 2,147,483,647 PLS in converted pulse data.
Target address 2		BFM #505, #504	BFM #605, #604	Setting range: -2,147,483,648 to 2,147,483,647 [User unit] ^{*1} Set the value within -2,147,483,648 to 2,147,483,647 PLS in converted pulse data
Ring operation rotation direction for absolute address		BFM #530	BFM #630	Sets the rotation direction when absolute address is specified in the ring operation. 0: Direction for shorter rotation 1: Direction where the current value increases (clockwise) 2: Direction where the current value decreases (counterclockwise)

*1. Refer to the section shown below for details on the user units.

→ Refer to Section 7.10

Target address setting range and rotation direction

Set the target address and rotation direction as follows.

- When specifying the address with an absolute value
In interrupt 1-speed constant quantity feed (except the constant position stop mode) and interrupt 2-speed constant quantity feed, even if the target address and rotation direction are specified in absolute values, the system operates as if they are specified in relative values.
 - Target address: Set a proper address suitable for positioning operation.
The setting range is from 0 to the ring counter upper limit value in the current address.
 - Rotation direction: Set the ring operation rotation direction for the absolute address.

In interrupt 1-speed constant quantity feed operation (constant position stop mode)

Specify the rotation direction using the sign of the target address 1.

- + : The system will operate in the direction in which the current value will increase.
- : The system will operate in the direction in which the current value will decrease.

Reciprocal movement instruction

Set the ring operation rotation direction for the absolute address to "0: Direction for shorter rotation".

- When specifying the address with a relative value
In interrupt 1-speed constant quantity feed, even if the target address and rotation direction are specified in absolute values, the system operates as if they are specified in relative values.
 - Target address: Set a proper address suitable for each positioning operation.
 - Rotation direction: Set a proper direction suitable for each positioning operation.

Mechanical zero-point address setting

For enabling ring operation in the current address, set the mechanical zero-point address within the following range.

Setting a value outside the setting range will cause an error.

Setting range: 0 to the ring value

Unlimited length feed in ring operation (Ver. 1.30 or later)

The 20SSC-H Ver. 1.30 or later supports unlimited length feed in ring operation when the absolute position detection system is used.

No setting is necessary for unlimited length feed.

However, the reciprocal movement instruction does not support unlimited length feed in ring operation when the absolute position detection system is used.

2. Applicable positioning operations

- | | |
|---|---|
| <ul style="list-style-type: none"> • Operations allowing the ring operation <ul style="list-style-type: none"> - Mechanical zero return - JOG operation - 1-speed positioning operation - Interrupt 1-speed constant quantity feed - 2-speed positioning operation - Interrupt 2-speed constant quantity feed - Interrupt stop - Variable speed operation - Multi-speed operation - Manual pulse generator operation - Reciprocal movement instruction
(Ver.1.10 or later) | <ul style="list-style-type: none"> • Operations not allowing the ring operation <ul style="list-style-type: none"> - Linear interpolation - Linear interpolation (interrupt stop) - Circular interpolation |
|---|---|

3. Operation

Example) System of units: degree Ring value: 359999

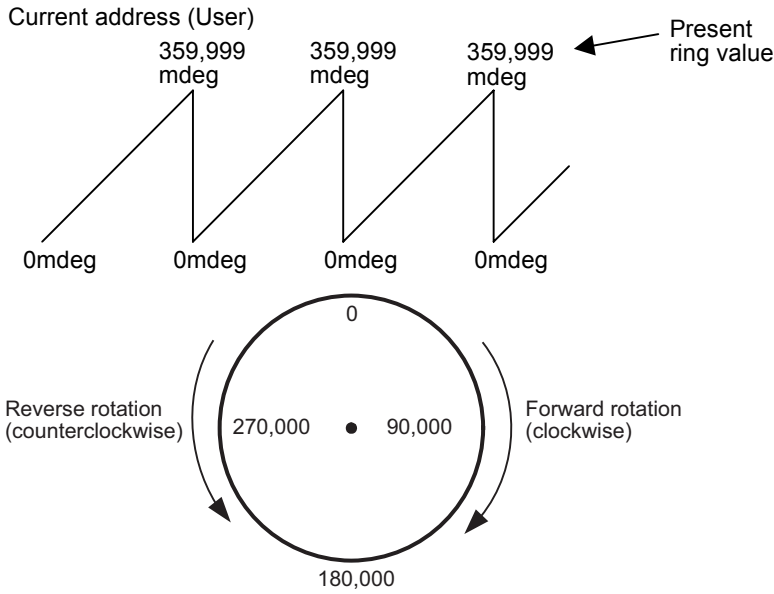

	BFM Number		Data type	
	X-axis	Y-axis		
Current address (user)	BFM #1,#0	BFM #101,#100	Monitor data	
Ring counter setting	Operation parameter 2	BFM #14002 b3	BFM #14202 b3	Positioning parameters
Ring counter upper limit value	BFM #14101,#14100	BFM #14301,#14300		Positioning parameters
Target address	Target address 1	BFM #501,#500	BFM #601,#600	Control data
	Target address 2	BFM #505,#504	BFM #605,#604	Control data
Ring operation rotation direction for absolute address	BFM #530	BFM #630		Control data

When the address is specified in absolute value:

- The 20SSC-H positions the motor in the rotation direction set in "Ring operation rotation direction for absolute address."
Set the value of BFM #530/#630
0: Direction for shorter rotation,
1: Direction where the current value increases (clockwise),
2: Direction where the current value decreases (counterclockwise)

Example of rotation in the direction for shorter rotation (BFM #530/#630: 0) (1-speed positioning operation)

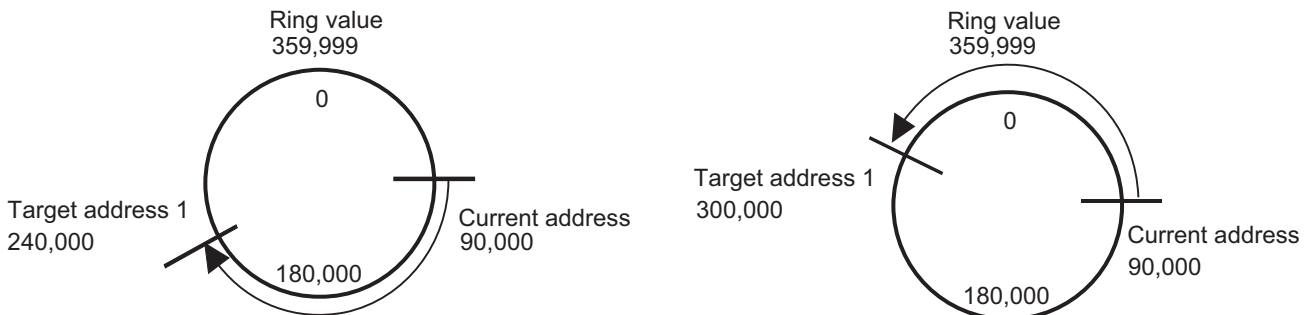

**Example of rotation in the direction where the current value increases (BFM #530/#630: 1)
(1-speed positioning operation)**

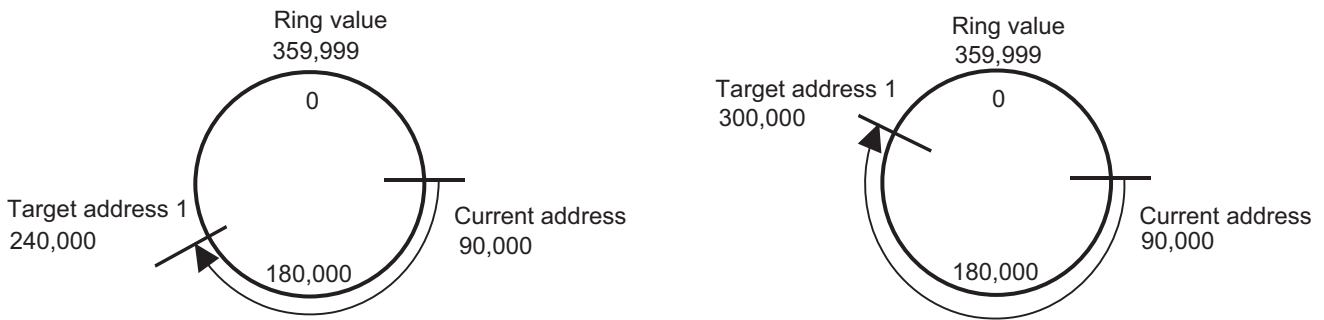

**Example of rotation in the direction where the current value decreases (BFM #530/#630: 2)
(1-speed positioning operation)**

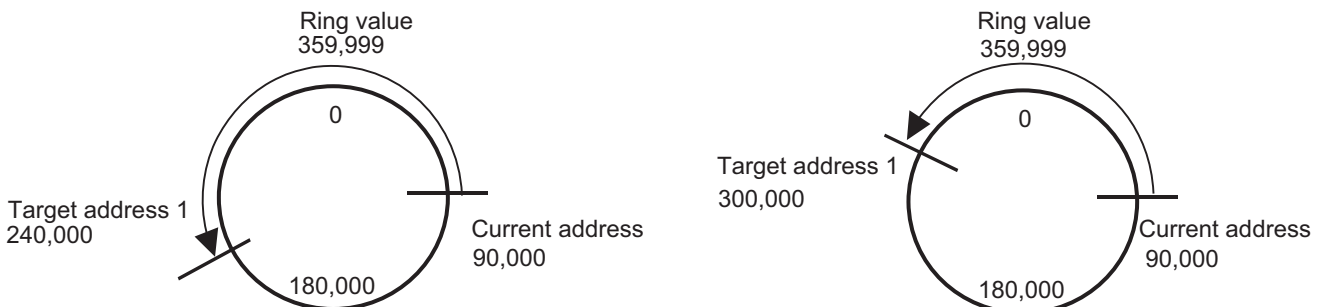

- When the current value is equivalent to the target address, positioning is completed (and the positioning completion signal turns ON).
- The 20SSC-H cannot position the motor to a value larger than the preset ring value.

When the address is specified in relative value:

- The 20SSC-H positions the motor while regarding the preset target address as a relative movement quantity.

**Example of rotation when the address is specified as a relative value
(1-speed positioning operation)**

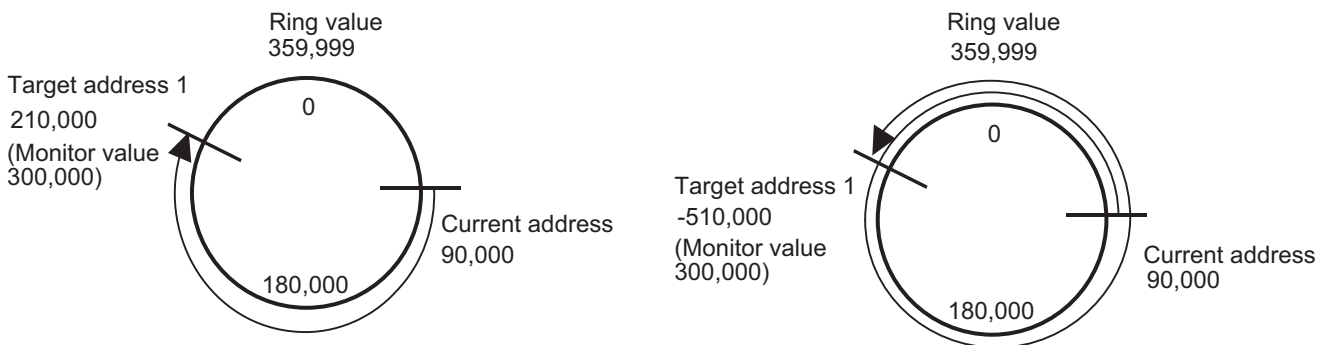

- The rotation direction is forward when the target address sign is "+", and reverse when the target address sign is "-."
- The 20SSC-H can position the motor to a value larger than the preset ring value.

1 Introduction

2 System configuration

3 Specifications

4 Installation

5 Wiring

6 Memory Config. and data operation

7 Before starting positioning operation

8 Manual control

9 Positioning Control

10 Table Operation

Cautions

- When specifying absolute addresses, set the target address within the range from 0 to the ring value. Setting a value outside the setting range will cause an error.
- When using Multi Speed operation will absolute addresses, if the total movement magnitude exceeds 32 bits, positioning will stop without continuing operation.
- When changing the current address using the current address change function, set a current address within the range from 0 to the ring value. Setting a value outside the setting range will cause an error.
- Set the mechanical zero point address within the range from 0 to the ring value. Setting a value outside the setting range will cause an error.
- The software limit setting is invalid during the ring operation.
- Performing interpolation during the ring operation causes error.

7.9 Other functions

The 20SSC-H has an absolute position detection system, torque limit function, servo ON/OFF, servo check functions and others.

The parameter setting and sequence program enable each function.

7.9.1 Servo-ready check function

The servomotor ready signal (completion of preparation) is checked during startup of operation or during operation. With no servo ready signal, a servo-ready error occurs, stopping the operation.

→ **For the parameters, control data and monitor data, refer to Chapter 11**

		BFM Number		Description
		X-axis	Y-axis	
Servo ready check enabled/disabled	Operation parameter 2	BFM #14002 b1	BFM #14202 b1	Enables or disables the servo ready check function. 1(ON): Enable 0(OFF): Disable
Ready ON	Servo status	BFM #64 b0	BFM #164 b0	This bit is set while the servo ready is ON.

7.9.2 Servo end check function

Use the servo end check function to detect the positioning operation completion by the servo status in-position signal. When the servo status in-position signal turns ON after operation completion (within the range of servo end check determination time) the 20SSC-H detects that the positioning operation has ended. When the in-position signal does not turn ON within the specified servo end determination time, an external error occurs, stopping the operation.

→ For the parameters, control data and monitor data, refer to Chapter 11

1. Set as follows when using the servo end check.

		BFM Number		Description
		X-axis	Y-axis	
Servo end check enabled/disabled	Operation parameter 2	BFM #14002 b0	BFM #14202 b0	Enables or disables the servo end check function. 1(ON): Enable 0(OFF): Disable
Servo end evaluation time		BFM #14032	BFM #14232	This parameter sets the evaluation time for the servo end check. Setting range: 1 to 5000 ms
In-position	Servo status	BFM #64 b12	BFM #164 b12	This bit is set while droop pulses are within a range of "In-position."
In-position range		BFM #15010	BFM #15210	Set the range to output a positioning completion signal in units of command pulses. Setting range: 0 to 65535 PLS

Servo end evaluation time

When the set value of the servo end evaluation time is outside the setting range, the set value is handled as follows:

- Zero or smaller settings are handled as "1ms."
- 5001 or larger settings are handled as "5000ms."

2. Applicable positioning operations

- Operations applicable to the servo end check
 - JOG operation
 - 1-speed positioning operation
 - Interrupt 1-speed constant quantity feed
 - 2-speed positioning operation
 - Interrupt 2-speed constant quantity feed
 - Interrupt stop
 - Variable speed operation
 - Multi-speed operation
 - Linear interpolation
 - Linear interpolation (interrupt stop)
 - Circular interpolation
 - Mechanical zero return
 - Reciprocal movement instruction (Ver.1.10 or later)
- Operations inapplicable to the servo end check
 - During continuous multi-speed operation
 - During continuous pass operation of interpolation operation
 - Manual pulse generator operation

7.9.3 Torque limit function

The torque limit function sets the torque limit value for the servo amplifier from the 20SSC-H.

This function can stop the servo motor if the load torque beyond the preset limit value is generated during positioning operation.

When the servo motor is stopped by the torque limit function, the "Servo status: torque limit reached" flag remains ON.

→ For the parameters, control data and monitor data, refer to Chapter 11

1. Positioning operation and torque limit value

The torque limit value used in the torque limit value function is as follows in accordance with the positioning operation status and each torque limit value setting status.

Setting of torque limit value used in each positioning operation

Positioning operation		Torque output set value	Used torque limit value
Mechanical zero return operation	The system operates at the zero return speed (creep).	-	Zero return torque limit value
	The system operates at the zero return speed (high speed).	0 1 to 10000 (× 0.1%)	Torque limit value Torque output setting value
<ul style="list-style-type: none"> • JOG operation • 1-speed positioning operation • Interrupt 1-speed constant quantity feed • 2-speed positioning operation • Interrupt 2-speed constant quantity feed • Interrupt stop • Variable speed operation 	<ul style="list-style-type: none"> • Multi-speed operation • Linear interpolation • Linear interpolation (interrupt stop) • Circular interpolation • Reciprocal movement instruction (Ver. 1.10 or later) • Manual pulse generator operation (Ver. 1.10 or later) 	0	Torque limit value
		1 to 10000 (× 0.1%)	Torque output setting value

Setting of torque limit value

	BFM Number		Description
	X-axis	Y-axis	
Zero return torque limit value	BFM #14040	BFM #14240	Setting range: 1 to 10000 (× 0.1%)
Torque limit value	BFM #14038	BFM #14238	Setting range: 1 to 10000 (× 0.1%)
Torque output setting value	BFM #510	BFM #610	Setting range: 0 to 10000 (× 0.1%)

2. Details of control

The operation with the torque limit is as follows.

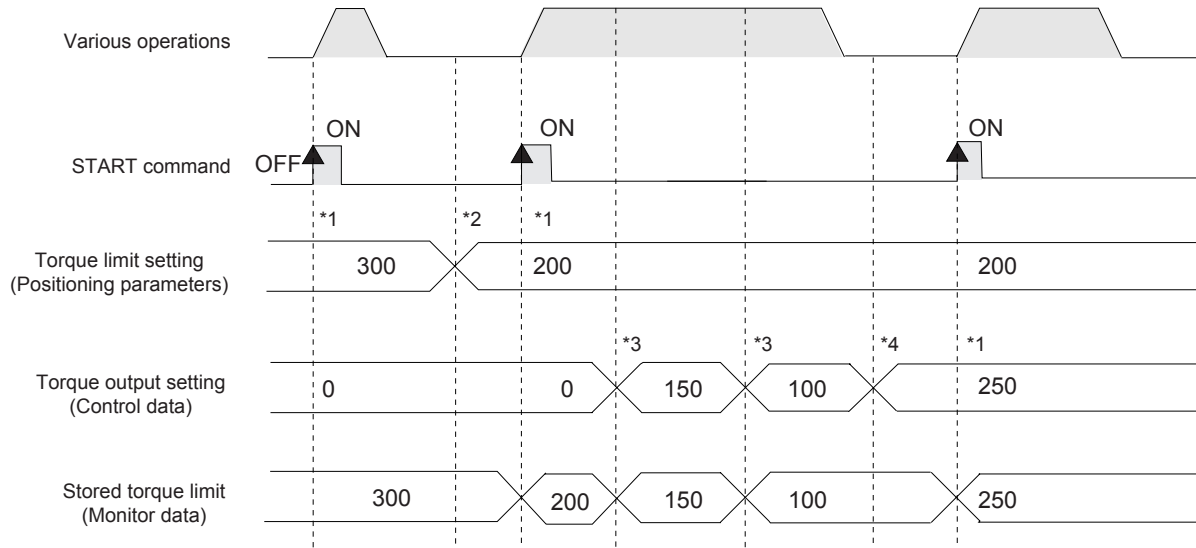

- *1 . The torque limit setting or torque output setting becomes valid at the rising edge of the START signal. If the torque output setting is "0," operation is made with the torque limit setting.
- *2 . If the positioning parameter setting is changed, issue a positioning control parameter command to validate the new setting.
- *3 . When the torque output setting is changed during operation, the changed value is reflected in operation and stored in the torque limit setting.
- *4 . When the torque output setting is changed during stop, the changed value is not reflected in operation and is stored in the torque limit setting when the START command turns ON from OFF.

		BFM Number		Data type
		X-axis	Y-axis	
START command	Operation command 1	BFM #518 b9	BFM #618 b9	Control data
Torque limit value setting	Torque limit value	BFM #14038	BFM #14238	Positioning parameters
	Zero return torque limit value	BFM #14040	BFM #14240	Positioning parameters
	Torque output setting value	BFM #510	BFM #610	Control data
Torque limit storing value		BFM #5,#4	BFM #105,#104	Monitor data
Positioning parameter enable command	Operation command 2	BFM #519 b4	BFM #619 b4	Control data
During torque limit ^{*5}	Servo status	BFM #64 b13	BFM #164 b13	Monitor data

- *5. While the servo motor is stopped by the torque limit function, the "Servo status: during torque limit" flag remains ON.

3. Precautions for control

- If the zero return torque limit value exceeds the torque limit setting, an error occurs.
- If the torque limit function causes the operation to stop, drop pulses remain in the deviation counter. After the load torque is removed, the operation continues according to the remaining pulses.

7.9.4 Absolute position detection system

An absolute position detection system is available with the 20SSC-H.

→ **For the parameters, control data and monitor data, refer to Chapter 11**

What is the absolute position detection system?

In the absolute position detection system, the current position is stored in the servo amplifiers battery backed memory, and even if the work piece moves at power failure, the moving distance is added to the current position with the absolute encoder and servo amplifier absolute position system. After power-ON, the absolute position detection system does not require the zero return procedure.

Caution

When the absolute current position from the zero-point exceeds the range of 32 bit data (-2,147,483,648 to 2,147,483,647), the current value overflow flag in the status information is ON and an error (error code: 3004) occurs at the time of next power supply starting.

Note

- The 20SSC-H Ver. 1.30 or later supports unlimited length feed in ring operation when the absolute position detection system is used. (The error in the above caution does not occur in this case.)
However, the reciprocal movement instruction does not support unlimited length feed in ring operation when the absolute position detection system is used.

→ **For ring operation, refer to Section 7.8**

- When zero return operation is performed using the absolute position detection system, the zero point information is saved in the flash memory in the 20SSC-H.
At this time, the number of writes to the flash memory (Maximum allowable number of writes: 100,000) is increased by "1."

If power supply is turned off while saving data into the flash memory, zero point information is not saved correctly to the flash memory, and an error (error code: 4013) occurs the next time the power supply is turned on.

In this case, perform zero return operation again after performing error reset.

→ **For the number of writes to the flash memory, refer to Subsection 11.3.34**

1. Conditions to use the absolute position detection system

- Use servomotors with absolute position encoders.
- Use a backup battery with the servo amplifier.
- Enable the absolute position detection system in the servo parameters.

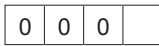
	BFM Number		Description
	X-axis	Y-axis	
Absolute position detection system	BFM #15003	BFM #15203	Select whether or not to use the absolute position detection system.  Absolute position detection system setting 0: Disable (use in incremental system) 1: Enable (use in absolute position detection system) CAUTION A parameter error occurs if you select "1: Enable (use in absolute position detection system)" when using the increment synchronous encoder.

2. Initial zero-point determination

Even with the absolute position detection system, the zero-point must be determined at least once after the equipment is manufactured.

To determine the zero-point for the first time, perform zero return according to one of the following types : data set type, DOG type or stopper type.

→ **For zero return operation, refer to Section 8.1**

3. Absolute position lost

If the absolute position in the encoder becomes indefinite in the absolute position detection system, the absolute position loss signal (ABSV) turns ON. At ABSV signal ON, make sure to operate zero return immediately to establish the zero-point again.

The absolute position becomes indefinite in the three cases below.

- When the absolute position detection system is set by the parameter setting of the servo amplifier, and the servo amplifier turns ON.
- An absolute position loss alarm (AL-25) is caused.
- An absolute position counter warning (AL-E3) is issued.

Note

While the absolute position loss signal (ABSV) is ON, do not start automatic operation. The zero-point must be established to prevent unpredictable behavior.

		BFM Number		Data type
		X-axis	Y-axis	
Zero return complete*1	Status information	BFM #28 b3	BFM #128 b3	Monitor data
Losing an absolute position	Servo status	BFM #64 b14	BFM #164 b14	Monitor data

*1. The zero return completion flag turns ON when mechanical zero return operation is completed, or when the current position is established by the absolute position detection system.

This flag turns OFF in the following cases.

- When the mechanical zero return command is set to ON from OFF
- When the power is turned OFF (The flag is reset.)
- When the absolute position is lost in the absolute position detection system
- When the rotation direction (servo parameter) is selected in the absolute position detection system

7.9.5 Servo ON/OFF

The servo of the servo amplifier connected with 20SSC-H turns ON/OFF.

The servo ON enables the servomotor operations.

In the 20SSC-H Ver. 1.30 or later, it is possible to set the servo ON/OFF status to be selected when the servo amplifier is started up.

→ For servo ON/OFF selection at startup, refer to Subsection 7.9.6

→ For the parameters, control data and monitor data, refer to Chapter 11

1. Servo ON/OFF

- Turn OFF(0) the servo-OFF command to turn the servo on.
- Turn ON (1) the servo-OFF command to turn the servo off.

		BFM Number		Description
		X-axis	Y-axis	
Servo OFF command	Operation command 2	BFM #519 b8	BFM #619 b8	Set this to turn the servo OFF. 0: Servo ON 1: Servo OFF
READY/BUSY	Status information	BFM #28 b0	BFM #128 b0	Turns ON when the 20SSC-H is ready for a START command after normal completion of positioning, or when recovering from an error.
Servo ON	Servo status	BFM #64 b1	BFM #164 b1	This bit is set when the servo is ON. Cleared when the servo turns OFF.

Note

- Perform servo-ON/OFF while the servomotor is stopped.
- The servo can be turned OFF with Ready-ON in the status information.
The servo-OFF command in the following states is invalid.
 - During positioning operation
 - When STOP command state is ON
- If the servomotor turns due to an external force during servo-OFF, a follow-up process occurs with the follow-up function.

→ For the follow-up function, refer to Subsection 7.9.7

7.9.6 Servo ON/OFF status selection at startup (Ver. 1.30 or later)

In the 20SSC-H Ver. 1.30 or later, it is possible to set the servo ON/OFF status to be selected when the PLC (including the 20SSC-H) and servo amplifier are started up^{*1}.

In a 20SSC-H earlier than Ver. 1.30, the servo amplifier is turned ON when the PLC (including the 20SSC-H) and servo amplifier are started up^{*1}.

→ For parameters, control data and monitor data, refer to Chapter 11

*1. The term "started up" indicates the following status:

- When communication between 20SSC-H and servo amplifier is established after system reset of the 20SSC-H is executed
- When communication between 20SSC-H and servo amplifier is established after the PLC (including the 20SSC-H) and servo amplifier are powered on
- When communication between 20SSC-H and servo amplifier is established after servo series is set

1. Servo ON/OFF status at startup

Set the servo ON/OFF status at startup in "Servo startup ON/OFF selection."

		BFM Number		Description
		X-axis	Y-axis	
Servo startup ON/OFF selection (Ver.1.30 or later)	Operation parameter 2	BFM #14002 b8	BFM #14202 b8	Set the servo ON/OFF status to be selected when the servo amplifier is started up (Ver. 1.30 or later). 1: Servo OFF The "servo OFF" status is selected when the servo amplifier is started up. Accordingly, it is necessary to specify the "servo ON" status using a sequence program. 0: Servo ON The "servo ON" status is automatically selected when the servo amplifier is started up. (This operation is same as the operation in products earlier than Ver. 1.30.)
Servo OFF command ^{*2}	Operation command 2	BFM #519 b8	BFM #619 b8	1: Servo OFF Set this to turn the servo OFF. 0: Servo ON Reset this to turn the servo ON.
Unit ready	Status information	BFM #28 b9	BFM #128 b9	This bit is set upon completion of 20SSC-H boot-up after power-on. (It is kept in the ON state until the power is turned off.) All buffer memory values become valid after the bit is set.
Servo ON	Servo status	BFM #64 b1	BFM #164 b1	This bit is set while the servo is ON. Cleared when the servo turns OFF.

*2. When "Servo OFF" is selected as the status to be selected at startup of the servo amplifier, the servo OFF command is "1 (ON)" at startup of the servo amplifier.

Update and setting of positioning parameters

Use the positioning parameter to select the servo ON/OFF status at startup.

This setting becomes valid when the 20SSC-H and servo amplifier are started up.

After this setting, it is necessary to start up again the PLC (including the 20SSC-H) and servo amplifier.

→ For setting of parameters, refer to Section 7.1

When "servo OFF" is selected as the servo amplifier status at startup

The "servo OFF" status is selected when the servo amplifier is started up. Specify the "servo ON" status using the following procedure.

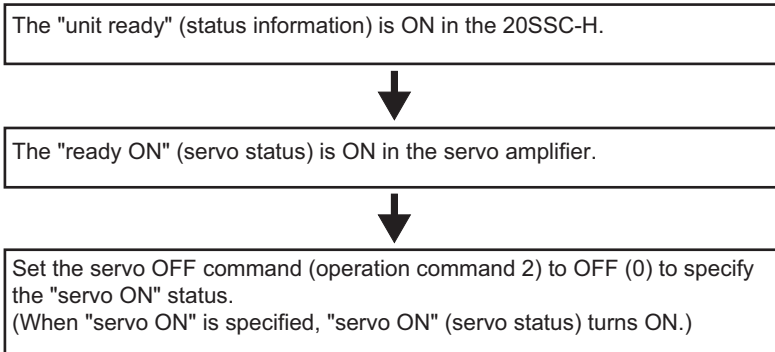

7.9.7 Follow-up function

With the follow-up function, the motor rpm is monitored when the servo is OFF, and the motor rpm is reflected in the current value.

With this function, even if the servomotor rotates while the servo is OFF, the servomotor always starts positioning at the next servo-ON, ignoring the drop pulse.

The 20SSC-H always executes the follow-up process during servo OFF. However, the current value may not be correctly reflected during motor deceleration after a forced stop or alarm occurrence.

Caution

Do not perform the release of a forced stop or release of an alarm during the deceleration of the motor caused by a forced stop or alarm occurrence. A servo motor carries out the amount of rotation equal to the dropped pulses, and there is a possibility that the machine will be damaged. Only perform the release of a forced stop or release of an alarm after confirming that the motor has stopped sufficiently.

7.9.8 Simultaneous start function

Operation in the X- and Y-axes start simultaneously with this function.

→ For the parameters, control data and monitor data, refer to Chapter 11

1. Applicable positioning operations

- Operations applicable to the simultaneous start function
 - JOG operation
 - Mechanical zero return
 - 1-speed positioning operation
 - Interrupt 1-speed constant quantity feed
 - 2-speed positioning operation
 - Interrupt 2-speed constant quantity feed
 - Interrupt stop
 - Table operation (individual)
 - Reciprocal movement instruction (Ver.1.10 or later)
- Operations inapplicable to the simultaneous start function
 - Manual pulse generator operation
 - Variable speed operation
 - Multi-speed operation
 - Linear interpolation
 - Linear interpolation (interrupt stop)

2. Operation

- 1) Enter the X-axis and Y-axis operation patterns.
- 2) Turn ON the X-axis simultaneous start flag.
- 3) Turn ON the X-axis start command.
In JOG operation, turn ON the X-axis forward/reverse rotation jog command.
- 4) X-axis and Y-axis operation begins simultaneously.

		BFM Number		Data type
		X-axis	Y-axis	
Operation pattern selection		BFM #520	BFM #620	Control data
Forward rotation JOG	Operation command 1	BFM #518 b4	BFM #618 b4	Control data
Reverse rotation JOG	Operation command 1	BFM #518 b5	BFM #618 b5	Control data
START command	Operation command 1	BFM #518 b9	BFM #618 b9	Control data
Simultaneous START flag	Operation command 1	BFM #518 b10		Control data

POINT

While the "simultaneous START" flag remains ON, the START command and forward rotation jog/reverse rotation jog for the Y-axis are ignored.

7.9.9 Current address change function

With this function, the current address of a stopped axis changes arbitrarily.

Write the desired value to the current address (user) to change, followed by the current address (pulse) update.

→ For parameters, control data and monitor data, refer to Chapter 11

Note

The current address does not change in the following states.

- READY/BUSY in the status information is OFF (0).
- Interruption due to a STOP command occurs and the operation is waiting for the remaining distance.

		BFM Number		Data type
		X-axis	Y-axis	
Current address (user)		BFM #1, #0	BFM #101, #100	Monitor data
Current address (pulse)		BFM #3, #2	BFM #103, #102	Monitor data
READY/BUSY	Status information	BFM #28 b0	BFM #128 b0	Monitor data
Standby for remaining travel distance at stop	Status information	BFM #28 b7	BFM #128 b7	Monitor data

7.9.10 Zero return interlock function

This function disables the start command before mechanical return.

→ For the parameters, control data and monitor data, refer to Chapter 11

1. Applicable positioning operations

- Operations applicable to the zero return interlock setting
 - 1-speed positioning operation
 - Interrupt 1-speed constant quantity feed
 - 2-speed positioning operation
 - Interrupt 2-speed constant quantity feed
 - Interrupt stop
 - Multi-speed operation
 - Linear interpolation
 - Linear interpolation (interrupt stop)
 - Table operation (individual)
 - Table operation (simultaneous)
 - Reciprocal movement instruction (Ver. 1.10 or later)
- Operations inapplicable to the zero return interlock setting
 - JOG operation
 - Manual pulse generator operation
 - Mechanical zero return
 - Variable speed operation

2. Setting items

When using the zero return interlock function, set to ON the "zero return interlock setting enabled/disabled" bit.

		BFM Number		Description
		X-axis	Y-axis	
Zero return interlock setting enabled/disabled	Operation parameter 2	BFM #14002 b2	BFM #14202 b2	Enables or disables the OPR interlock function. 1(ON): Enable Disables the START command without zero return completion. Enables the START command with zero return completion (zero return completed: ON) 0(OFF): Disable
Zero return complete	Status information	BFM #28 b3	BFM #128 b3	Turns ON upon completion of mechanical zero return operation, or when the current position is established by the absolute position detection system. Turns OFF at OFF-to-ON transition of a mechanical zero return command, at power-off (reset), or when an absolute position is lost during the absolute position detection system.

Condition disabling the zero return interlock function

The zero return interlock function is disabled in the following cases:

- When the "zero return interlock setting enable/disabled" bit is set to "OFF"
- When the "zero return complete" flag is ON

7.9.11 Positioning completion signal output waiting time (Ver.1.20 or later)

In positioning operation shorter than one scan time of the PLC, the system cannot detect "OFF" of the positioning completion signal. As a result, the system cannot detect the status transition "from OFF to ON" of the positioning completion signal, and cannot set to ON the next START command.

If the positioning completion signal output waiting time is set to one scan time or longer, the system can detect the positioning completion signal in a sequence program, and can set to ON the next positioning START command.

For positioning operation sufficiently longer than one scan time of the PLC, it is not necessary to set the positioning completion signal output waiting time.

→ For the parameters, control data and monitor data, refer to Chapter 11

1. Positioning completion signal output waiting time setting

Set the time until the positioning completion flag turns ON after positioning is completed.

		BFM Number		Description
		X-axis	Y-axis	
Positioning completion signal output waiting time		BFM #14106	BFM #14306	Setting range: 0 to 5000 ms
Positioning completion	Status information	BFM #28 b6	BFM #128 b6	These bits are set (to ON) when positioning operation is normally completed, and reset (to OFF) when the START command is set to ON, when an error occurs, or when the error reset command is set to ON.*1 These bits remain OFF after positioning is stopped by the STOP command.

*1. The positioning completion signal turns ON in the following operations.

However, the positioning completion signal remains OFF even in an operation in which the positioning completion signal usually turns ON if the position stopped by the STOP command is equivalent to the target address position.

- | | | |
|--|---|---|
| <ul style="list-style-type: none"> • Operations in which the positioning completion signal turns ON <ul style="list-style-type: none"> - Mechanical zero return operation (DOG, stopper type) - 1-speed positioning operation - Interrupt 1-speed constant quantity feed operation - 2-speed positioning operation - Interrupt 2-speed constant quantity feed | <ul style="list-style-type: none"> - Interrupt stop - Multi-speed operation - Linear interpolation - Linear interpolation (interrupt stop) - Circular interpolation - Reciprocal movement instruction (Ver.1.10 or later) | <ul style="list-style-type: none"> • Operations in which the positioning completion signal does not turn ON <ul style="list-style-type: none"> - Mechanical zero return operation (data set type) - JOG operation - Manual pulse generator operation - Variable speed operation |
|--|---|---|

2. Operation

The system will perform the following operation when the positioning completion signal output waiting time is set.

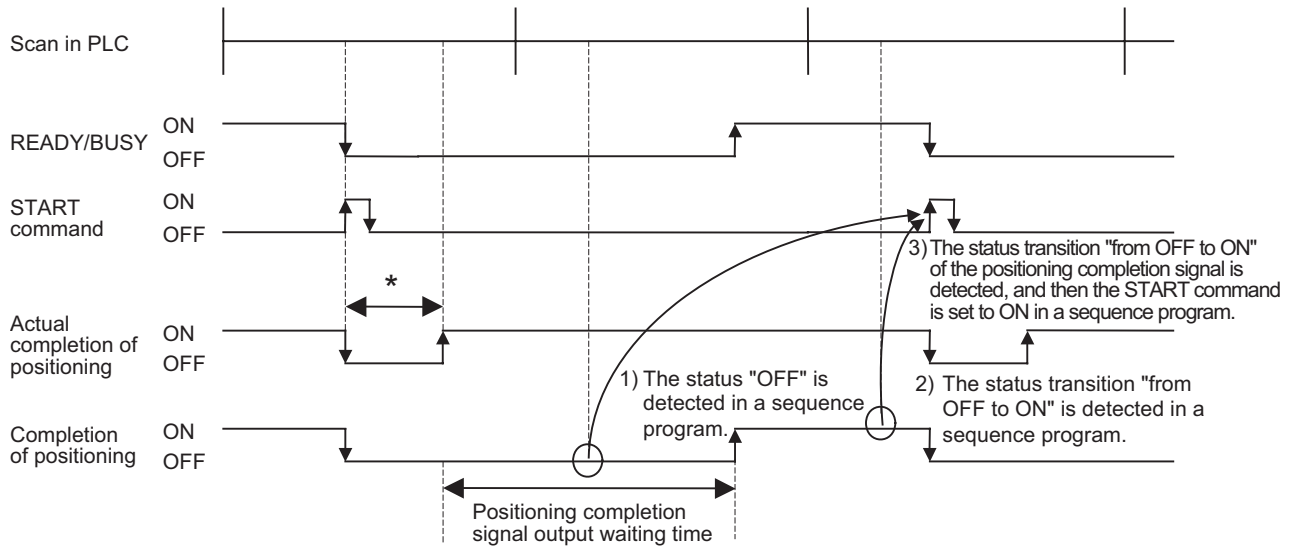

* Positioning operation shorter than a scan in PLC.

		BFM Number		Data type
		X-axis	Y-axis	
READY/BUSY	Status information	BFM #28 b0	BFM #128 b0	Monitor data
Positioning completion	Status information	BFM #28 b6	BFM #128 b6	Monitor data
Positioning completion signal output waiting time		BFM #14106	BFM #14306	Positioning parameters
STOP command (deceleration stop)	Operation command 1	BFM #518 b1	BFM #618 b1	Control data
Mechanical zero return command	Operation command 1	BFM #518 b6	BFM #618 b6	Control data
START command	Operation command 1	BFM #518 b9	BFM #618 b9	Control data
X-START (input terminal)		-	-	-
Y-START (input terminal)		-	-	-

POINT

- Becomes 5000 ms when set at 5001 ms or more.
- If positioning is completed and an error occurs during the positioning completion signal output waiting time, the positioning completion signal remains OFF.
- The setting of the positioning completion signal output waiting time is invalid during table operation.

7.9.12 System reset command (Ver.1.10 or later)

The system reset command resets the 20SSC-H system.

This command resets the system with the falling edge of the system reset command after b1 remains ON for 100 ms or more.

→ For the operation command 2, refer to Subsection 11.4.11

→ For a program example, refer to Subsection 7.1.4

		BFM Number		Description
		X-axis	Y-axis	
System reset command	Operation command 2	BFM #519 b1		Set this bit to ON (keep it ON for 100 ms or more), and then set it to OFF in a sequence program.

How to execute the system reset command

Write the model code (K5220) to the control command enable/disable (BFM #522) before executing the system reset command.

	BFM Number		Description
	X-axis	Y-axis	
Control command enable/disable	BFM #522		Write K5220 in a sequence program.

Note

- When the 20SSC-H version is Ver. 1.10 or later:
After changing the servo parameters stored in the flash memory, it is not necessary to turn OFF and ON the power for transferring the servo parameters stored in the flash memory to the servo amplifier if the system reset command is executed.
The system reset command is also convenient when using the function to transfer the servo parameters set in the sequence program to the servo amplifier.
→ For the method to transfer the servo parameters set in the sequence program to the servo amplifier, refer to Subsection 6.2.3, 7.1.4 and 7.1.5
- When the 20SSC-H version is earlier than Ver. 1.10:
After changing the servo parameters stored in the flash memory, it is necessary to turn OFF and ON the power for transferring the servo parameters stored in the flash memory to the servo amplifier.

Operation

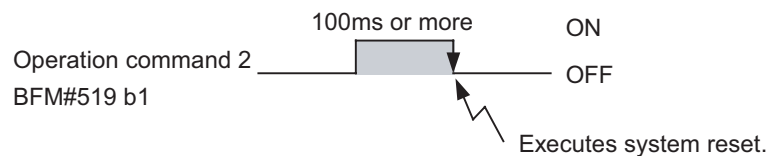

7.9.13 Servo parameter update stop (Ver.1.10 or later)

The servo parameter update stop command disables the update of the servo parameters stored in the 20SSC-H buffer memory even when the servo parameters are updated in the servo amplifier.

A sequence program can change the servo parameters stored in the buffer memory in the 20SSC-H and write updated values to the flash memory while the servo parameter update stop command is ON.

→ For the operation command 2, refer to Subsection 11.4.11

→ For a program example, refer to Subsection 7.1.6

		BFM Number		Description
		X-axis	Y-axis	
Servo parameter update stop	Operation command 2	BFM #519 b1	BFM #619 b1	1 (ON): Does not update servo parameters even if the servo amplifier sends the servo parameter update request. 0 (OFF): Transfers servo parameters to the buffer memory (for update) when the servo amplifier sends the servo parameter update request.

Note

The 20SSC-H does not update the servo parameters stored in the buffer memory while the servo parameter update stop command is ON.

After transferring servo parameters to the servo amplifier, set this command to OFF as necessary to restart automatic update of servo parameters.

7.10 Precautions for using the user units (mechanical or composite system of units)

1. User units

Set the units for position and speed using operation parameter 1.

→ For details of operation parameter 1, refer to Subsection 11.1.1

1) System of units

Select the units to use.

The contents of setting are explained in "2) Set values for user units."

- Motor system of units :The position command and speed command are based on the number of pulses.
- Mechanical system of units :The position command and speed command are based on mm, mdeg, 10⁻⁴ inches and so on.
- Composite system of units :The position command is based the mechanical system, while the speed command is based on the motor system, or similar composite units are used.

Note

When the system of units is set to "mechanical system of units" or "composite system of units", it is necessary to set the pulse rate and feed rate.

2) Set values for user units

Set the units for position and speed as user units.

The following settings are offered by combinations of the system of units (b1 and b0) and unit setting (b3 and b2).

The unit for position is multiplied by "1", "10", "100" or "1000" in accordance with the setting of the position data magnification setting.

→ For position data magnification, refer to "3) Position data magnification"

System of units	Units		X-axis: BFM #14000, Y-axis: BFM #14200			
	Position unit	Speed unit	User unit setting		System of units setting	
			b3	b2	b1	b0
Motor system of units	PLS	Hz	-	-	0	0
Mechanical system of units	μm	cm/min	0	0	0	1
	10 ⁻⁴ inch	inch/min	0	1	0	1
	mdeg	10deg/min	1	0	0	1
Composite system of units	μm	Hz	0	0	1	0/1
	10 ⁻⁴ inch		0	1	1	0/1
	mdeg		1	0	1	0/1

3) Data magnification

Selects the position data magnification (×1, ×10, ×100 or ×1000).

Position data magnification	Unit setting (position unit)				X-axis: BFM #14000, Y-axis: BFM #14200	
	PLS	μm	inch	mdeg	Position data magnification	
					b5	b4
×1	PLS	μm	× 0.0001 inch	mdeg	0	0
×10	× 10 PLS	× 10 μm	× 0.001 inch	× 10 mdeg	0	1
×100	× 100 PLS	× 100 μm	× 0.01 inch	× 100 mdeg	1	0
×1000	× 1000 PLS	mm	× 0.1 inch	deg	1	1

Note

The following position data is magnified by the position data magnification setting:

- Mechanical zero-point address
- Software limit (upper)
- Software limit (lower)
- Target address 1
- Target address 2
- Target position change value (address)
- Table information (Position information)
- Table information (Circular information)
- Current address (user)
- Current address (pulse)
- Real current address (user)
- Real current address (pulse)

Example:

When target address 1 is "123" and the position data magnification is "x1000", the actual address (or travel distance) is as follows in accordance with the system of units:

Motor system of units: $123 \times 1000 = 123000(\text{PLS})$

Mechanical system, Composite system of units: $123 \times 1000 = 123000(\mu\text{m, mdeg, } 10^{-4}\text{inch})$
 $= 123(\text{mm, deg, } 10^{-1}\text{inch})$

2. Converted pulse data

Enter data within the setting range of converted pulse data, when setting ranges overlap. The equation for conversion is as follows.

1) Travel distance

Travel distance in converted pulse data (PLS) =
 $\text{Travel distance } (\mu\text{m, } 10^{-4}\text{inch, mdeg}) \times \text{position data magnification} \times (\text{pulse rate} / \text{feed rate})$

2) Operation speed

Operation speed in converted pulse data (Hz) =
 $\text{Operation speed (cm/min, inch/min, } 10\text{deg/min)} \times 10^4 \times (\text{pulse rate} / \text{feed rate}) / 60$

		BFM Number		Data type
		X-axis	Y-axis	
Pulse rate		BFM #14005,#14004	BFM #14205,#14204	Positioning parameters
Feed rate		BFM #14007,#14006	BFM #14207,#14206	Positioning parameters
Position data magnification	Operation parameter	BFM #14000 b5,b4	BFM #14200 b5,b4	Positioning parameters
Travel distance	Target address 1	BFM #501,#500	BFM #601,#600	Control data
	Target address 2	BFM #505,#504	BFM #605,#604	Control data
Operation speed setting	Operation speed 1	BFM #503,#502	BFM #603,#602	Control data
	Operation speed 2	BFM #507,#506	BFM #607,#606	Control data

Servomotor rotation speed and operation speed (converted pulse data)

Do not exceed the maximum rotation speed of the servomotor when specifying the operation speed (including the maximum speed, jog speed and zero return speed). The servomotor rotation speed is calculated from the speed (converted pulse data) as follows.

Servomotor rpm (r/min) =

$\text{The converted pulse data of operation speed (Hz)} \times 60 / \text{the resolution per revolution of servomotor}$

Servo amplifier	Resolution per revolution or servomotor (PLS/REV)
MR-J3-□B, MR-J3W-□B, MR-J3-□BS, MR-J4(W2)-□B(J3 compatibility mode)	262144

3. Error

Supposing that the pulse rate be A, feed rate be B, and relative travel distance be C, $C \times (A/B)$ is the number of pulses output from 20SSC-H.

No command error occurs as long as (A/B) is an integer. $C \times (A/B)$ does not have to be an integer.

However, if $C \times (A/B)$ is not an integer, repetitive operation of relative movement causes an accumulated error in the current address. In absolute address operation, an error within 1 pulse occurs with the calculation result rounded off, but it does not cause an accumulated error.

In addition, an accumulated error does not occur in the motor system of units.

4. Maximum speed restriction

To specify speed data in the mechanical system of units, enter data in the range between 1 and 50,000,000Hz in converted pulse data.

7.11 Cautions for Positioning Operation

7.11.1 Overlapped specification of operation mode

- 1) The positioning operation does not start at START input/command if multiple operation patterns are selected (with multiple bits turned on) in the parameters for operating patterns.
- 2) When two or more positioning operation commands are ON at the same time such as the forward rotation JOG/reverse rotation JOG command and mechanical zero return command (operation command I), such commands are executed with the following priority.

Priority of positioning operation commands:

START command > Forward rotation JOG > Reverse rotation JOG > Mechanical zero return command

If the forward rotation JOG command and reverse rotation JOG command turn ON at the same time, however, the forward rotation JOG/reverse rotation JOG commands are ignored.

		BFM Number		Data type
		X-axis	Y-axis	
Operation pattern selection		BFM #520	BFM #620	Control data
Forward rotation JOG	Operation command 1	BFM #518 b4	BFM #618 b4	Control data
Reverse rotation JOG	Operation command 1	BFM #518 b5	BFM #618 b5	Control data
Mechanical zero return command	Operation command 1	BFM #518 b6	BFM #618 b6	Control data
START command	Operation command 1	BFM #518 b9	BFM #618 b9	Control data
X-START (input terminal)		-	-	-
Y-START (input terminal)		-	-	-

7.11.2 When the travel distance is small

1. 1-speed positioning operation

If the time needed for the travel distance (target address 1) is shorter than the acceleration/deceleration time, the actual operation speed does not reach the command speed (operation speed 1).

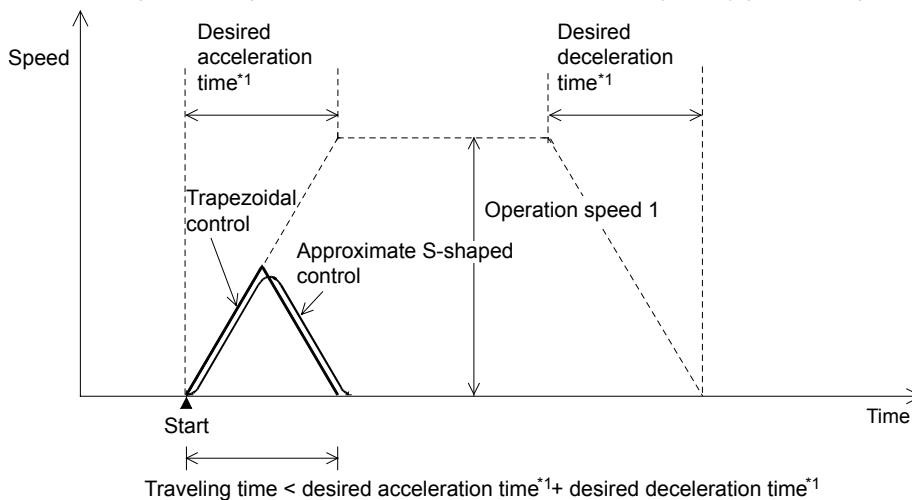

*1. For the relation between the time for the actual acceleration/deceleration and the specified time for desired acceleration/deceleration, refer to the following.

→ Refer to Section 7.2

		BFM Number		Data type
		X-axis	Y-axis	
Target address 1		BFM #501, #500	BFM #601, #600	Control data
Operation speed 1		BFM #503, #502	BFM #603, #602	Control data
Acceleration/deceleration time change command (Ver.1.30 or later)	Operation command 2	BFM #519 b5	BFM #619 b5	Control data

		BFM Number		Data type
		X-axis	Y-axis	
Maximum speed		BFM #14009, #14008	BFM #14209, #14208	Positioning parameters
Acceleration time		BFM #14018	BFM #14218	Positioning parameters
Deceleration time		BFM #14020	BFM #14220	Positioning parameters
Acceleration/deceleration mode*1	Operation parameter	BFM #14000 b11	BFM #14200 b11	Positioning parameters
Acceleration time 2 (Ver.1.30 or later)		BFM #14108	BFM #14308	Positioning parameters
Deceleration time 2 (Ver.1.30 or later)		BFM #14110	BFM #14310	Positioning parameters

*1. Set approximate S-shaped acceleration/deceleration or trapezoidal acceleration/deceleration in "acceleration/deceleration mode."

2. Interrupt 1-speed positioning operation

(Ver. earlier than 1.10, or BFM#519, #619 b6=OFF in Ver. 1.10 or later)

If the time needed for the travel distance (target address 1) is shorter than the deceleration time, the pulse output stops at the target address 1.

If the travel distance is zero, immediate stop occurs when interrupt input INT0 turns ON.

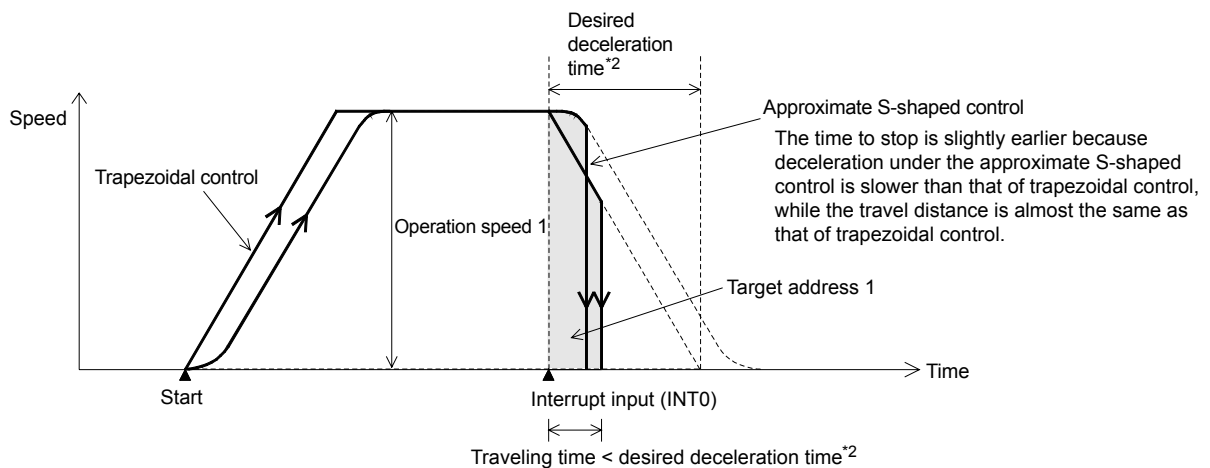

*2. For the relation between the time for the actual deceleration and the specified time for desired deceleration, refer to the following.

→ Refer to Section 7.2

		BFM Number		Data type
		X-axis	Y-axis	
Target address 1		BFM #501, #500	BFM #601, #600	Control data
Operation speed 1		BFM #503, #502	BFM #603, #602	Control data
Acceleration/deceleration time change command (Ver. 1.30 or later)	Operation command 2	BFM #519 b5	BFM #619 b5	Control data
Mode selection for the Interrupt 1-speed constant quantity feed	Operation command 2	BFM #519 b6	BFM #619 b6	Control data
X-INT0 (input terminal)		-	-	Input terminal
Y-INT0 (input terminal)		-	-	Input terminal
Maximum speed		BFM #14009, #14008	BFM #14209, #14208	Positioning parameters
Acceleration time		BFM #14018	BFM #14218	Positioning parameters
Deceleration time		BFM #14020	BFM #14220	Positioning parameters
Acceleration/deceleration mode*3	Operation parameter 1	BFM #14000 b11	BFM #14200 b11	Positioning parameters
Acceleration time 2 (Ver.1.30 or later)		BFM #14108	BFM #14308	Positioning parameters
Deceleration time 2 (Ver.1.30 or later)		BFM #14110	BFM #14310	Positioning parameters

*3. Set approximate S-shaped acceleration/deceleration or trapezoidal acceleration/deceleration in "acceleration/deceleration mode."

- 1 Introduction
- 2 System configuration
- 3 Specifications
- 4 Installation
- 5 Wiring
- 6 Memory Config. and data operation
- 7 Before starting positioning operation
- 8 Manual control
- 9 Positioning Control
- 10 Table Operation

**3. Interrupt 1-speed constant quantity feed (constant position stop mode)
(in Ver. 1.10 or later, when "ring counter setting" in the current address (b3 of BFM #14002/
#14202) is ON and "mode selection for interrupt 1-speed constant quantity feed" (b6 of BFM
#519/#619) is ON)**

The system operates as follows when the travel distance to the target position (target address 1) after the interrupt input (INT0) turns ON is shorter than the travel distance required for a deceleration stop:

1) When the version is earlier than Ver. 1.30

If the system cannot stop at the target position (target address 1) by the setting value of deceleration time, it passes the 1st target position (target address 1), decelerates, and then stops in the 2nd target position (target address 1). (Refer to Fig. A.)

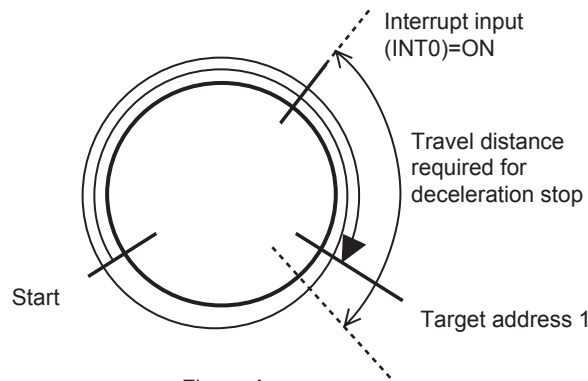

Figure A

		BFM Number		Data type
		X-axis	Y-axis	
Target address 1		BFM #501,#500	BFM #601,#600	Control data
Operation speed 1		BFM #503,#502	BFM #603,#602	Control data
Acceleration/deceleration time change command (Ver.1.30 or later)	Operation command 2	BFM #519 b5	BFM #619 b5	Control data
Mode selection for the Interrupt 1-speed constant quantity feed	Operation command 2	BFM #519 b6	BFM #619 b6	Control data
X-INT0 (input terminal)		-	-	Input terminal
Y-INT0 (input terminal)		-	-	Input terminal
Maximum speed		BFM #14009,#14008	BFM #14209,#14208	Positioning parameters
Acceleration time		BFM #14018	BFM #14218	Positioning parameters
Deceleration time		BFM #14020	BFM #14220	Positioning parameters
Acceleration/deceleration mode*1	Operation parameter 1	BFM #14000 b11	BFM #14200 b11	Positioning parameters
Ring counter upper limit value (Ver. 1.10 or later)		BFM #14101,#14100	BFM #14301,#14300	Positioning parameters
Ring counter setting (Ver.1.10 or later)	Operation parameter 2	BFM #14002 b3	BFM #14202 b3	Positioning parameters
Acceleration time 2 (Ver.1.30 or later)		BFM #14108	BFM #14308	Positioning parameters
Deceleration time 2 (ver.1.30 or later)		BFM #14110	BFM #14310	Positioning parameters

*1. Set approximate S-shaped acceleration/deceleration or trapezoidal acceleration/deceleration in "acceleration/deceleration mode."

2) When the version is Ver.1.30 or later and "interrupt 1-speed constant quantity feed (constant position stop mode) shortest allowable stop" is disabled, the system performs in the same way as versions earlier than Ver. 1.30.

- 3) When the version is Ver.1.30 or later "interrupt 1-speed constant quantity feed (constant position stop mode) shortest allowable stop" is enabled. (Refer to Fig. B.)

If the system cannot stop at the target position (target address 1) with the setting value of deceleration time, it stops at the target position (target address 1) using a deceleration time^{*1} set by the 20-SSC-H automatically. (Refer to Fig. B.)

However, if the travel distance to the target position (target address 1) after the interrupt input (INT0) turns ON is shorter than the travel distance required for a sudden stop, the system passes the 1st target position (target address 1), decelerates, and then stops at the 2nd target position (target address 1). (Refer to Fig. C.)

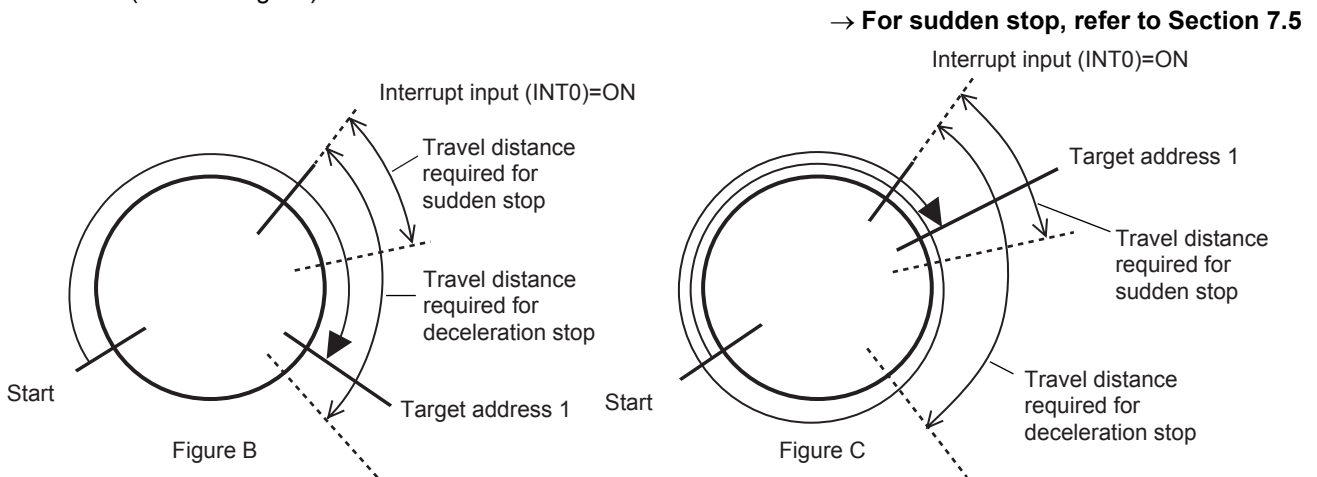

- *1. Deceleration time setting value is automatically set between sudden stop deceleration time and deceleration time.

		BFM Number		Data type
		X-axis	Y-axis	
Target address 1		BFM #501,#500	BFM #601,#600	Control data
Operation speed 1		BFM #503,#502	BFM #603,#602	Control data
Acceleration/deceleration time change command (Ver.1.30 or later)	Operation command 2	BFM #519 b5	BFM #619 b5	Control data
Mode selection for the Interrupt 1-speed constant quantity feed	Operation command 2	BFM #519 b6	BFM #619 b6	Control data
Interrupt 1-speed Constant Quantity Feed (Constant position stop mode) shortest allowable stop (Ver.1.30 or later)	Operation command 2	BFM #519 b7	BFM #619 b7	Control data
X-INT0 (input terminal)		-	-	Input terminal
Y-INT0 (input terminal)		-	-	Input terminal
Maximum speed		BFM #14009,#14008	BFM #14209,#14208	Positioning parameters
Acceleration time		BFM #14018	BFM #14218	Positioning parameters
Deceleration time		BFM #14020	BFM #14220	Positioning parameters
Acceleration/deceleration mode ^{*2}	Operation parameter 1	BFM #14000 b11	BFM #14200 b11	Positioning parameters
Ring counter setting (Ver.1.10 or later)	Operation parameter 2	BFM #14002 b3	BFM #14202 b3	Positioning parameters
Sudden stop deceleration time (Ver.1.20 or later)		BFM #14102	BFM #14302	Positioning parameters
Acceleration time 2 (Ver.1.30 or later)		BFM #14108	BFM #14308	Positioning parameters
Deceleration time 2 (Ver.1.30 or later)		BFM #14110	BFM #14310	Positioning parameters

- *2. Set approximate S-shaped acceleration/deceleration or trapezoidal acceleration/deceleration in "acceleration/deceleration mode."

4. 2-speed positioning operation

1) If the travel distance at the first speed is small

If the travel time is smaller than the time ^{*1} needed to decelerate to the operation speed 2, the first operation speed does not reach the operation speed 1.

If the travel distance of the first speed is zero, the travel is at the second operation speed and travel distance. (No error is caused.)

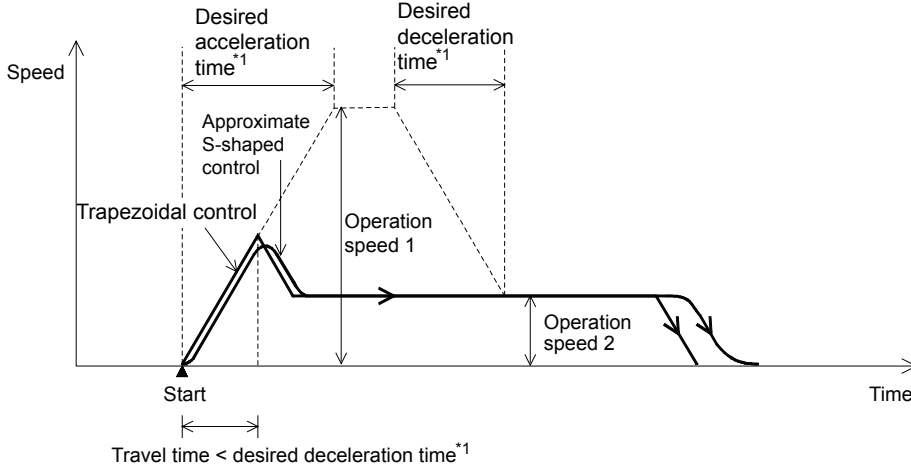

*1. For the relation between the time for the actual deceleration and the specified time for desired deceleration, refer to the following.

→ Refer to Section 7.2

		BFM Number		Data type
		X-axis	Y-axis	
Travel distance	Target address 1	BFM #501,#500	BFM #601,#600	Control data
	Target address 2	BFM #505,#504	BFM #605,#604	Control data
Operation speed setting	Operation speed 1	BFM #503,#502	BFM #603,#602	Control data
	Operation speed 2	BFM #507,#506	BFM #607,#606	Control data
Acceleration/deceleration time change command (Ver.1.30 or later)	Operation command 2	BFM #519 b5	BFM #619 b5	Control data
Maximum speed		BFM #14009,#14008	BFM #14209,#14208	Positioning parameters
Acceleration time		BFM #14018	BFM #14218	Positioning parameters
Deceleration time		BFM #14020	BFM #14220	Positioning parameters
Acceleration/deceleration mode ^{*2}	Operation parameter 1	BFM #14000 b11	BFM #14200 b11	Positioning parameters
Acceleration time 2 (Ver.1.30 or Later)		BFM #14108	BFM #14308	Positioning parameters
Deceleration time 2 (Ver.1.30 or later)		BFM #14110	BFM #14310	Positioning parameters

*2. Set approximate S-shaped acceleration/deceleration or trapezoidal acceleration/deceleration in "acceleration/deceleration mode."

2) If the travel distance of the second speed is small

If the travel time at the second speed is smaller than the time^{*1} needed to decelerate from the operation speed 2, deceleration is started from operation speed 1.

If the travel distance at the second speed is zero, the operation decelerates to stop for the travel distance to be the target address 1 as if it were a 1-speed positioning operation. (No error is caused.)

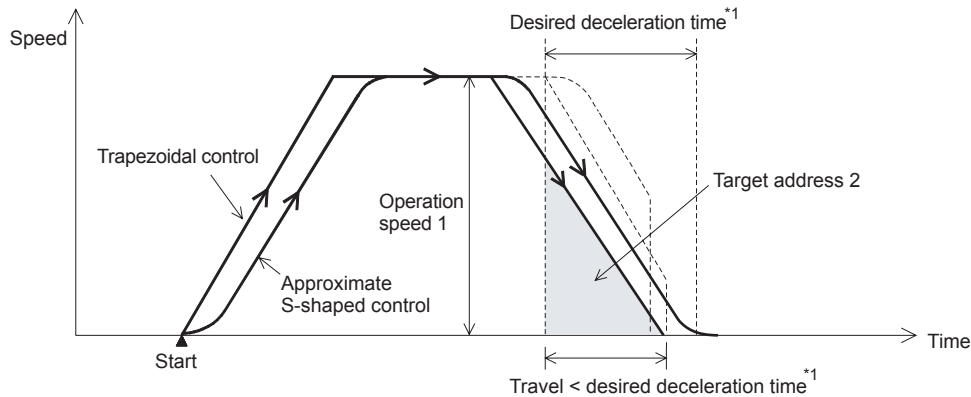

*1. For the relation between the time for the actual deceleration and the specified time for desired deceleration, refer to the following.

→ Refer to Section 7.2

		BFM Number		Data type
		X-axis	Y-axis	
Travel distance	Target address 1	BFM #501,#500	BFM #601,#600	Control data
	Target address 2	BFM #505,#504	BFM #605,#604	Control data
Operation speed setting	Operation speed 1	BFM #503,#502	BFM #603,#602	Control data
	Operation speed 2	BFM #507,#506	BFM #607,#606	Control data
Acceleration/deceleration time change command (Ver.1.30)	Operation command 2	BFM #519 b5	BFM #619 b5	Control data
Maximum speed		BFM #14009,#14008	BFM #14209,#14208	Positioning parameters
Acceleration time		BFM #14018	BFM #14218	Positioning parameters
Deceleration time		BFM #14020	BFM #14220	Positioning parameters
Acceleration/deceleration mode ^{*2}	Operation parameter 1	BFM #14000 b11	BFM #14200 b11	Positioning parameters
Acceleration time 2 (Ver.1.30 or later)		BFM #14108	BFM #14308	Positioning parameters
Deceleration time 2 (Ver.1.30 or later)		BFM #14110	BFM #14310	Positioning parameters

*2. Set approximate S-shaped acceleration/deceleration or trapezoidal acceleration/deceleration in "acceleration/deceleration mode."

5. Interrupt 2-speed constant quantity feed

If the time required for the travel distance (up to target address 1) is shorter than the time required for deceleration^{*1}, the system stops pulse outputs when it reaches the target address 1 in deceleration. If the travel distance is "0", the system immediately stops when the interrupt input (INT1) turns ON.

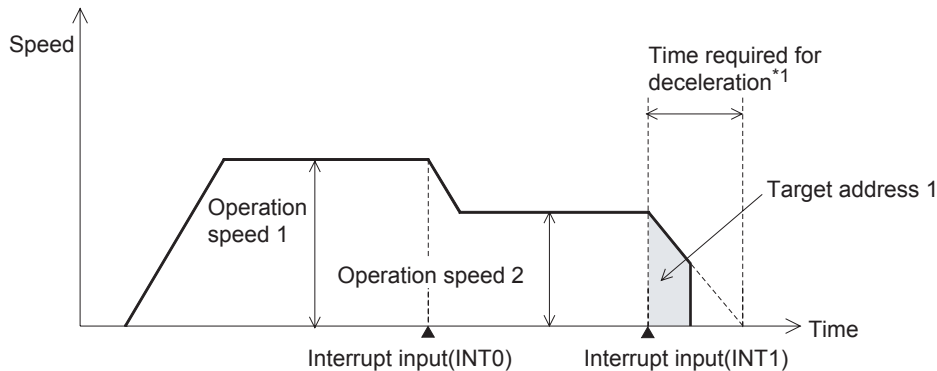

*1. For the relationship between the time required for deceleration and the deceleration time (positioning parameter), refer to the following.

→ Refer to Section 7.2

		BFM Number		Data type
		X-axis	Y-axis	
Target address 1		BFM #501,#500	BFM #601,#600	Control data
Operation speed setting	Operation speed 1	BFM #503,#502	BFM #603,#602	Control data
	Operation speed 2	BFM #507,#506	BFM #607,#606	Control data
Acceleration/deceleration time change command (Ver. 1.30 or later)	Operation command 2	BFM #519 b5	BFM #619 b5	Control data
X-INT0 (input terminal)		-	-	Input terminal
Y-INT0 (input terminal)		-	-	Input terminal
X-INT1 (input terminal)		-	-	Input terminal
Y-INT1 (input terminal)		-	-	Input terminal
Maximum speed		BFM #14009,#14008	BFM #14209,#14208	Positioning parameters
Acceleration time		BFM #14018	BFM #14218	Positioning parameters
Deceleration time		BFM #14020	BFM #14220	Positioning parameters
Acceleration/deceleration mode ^{*2}	Operation parameter 1	BFM #14000 b11	BFM #14200 b11	Positioning parameters
Acceleration time 2 (Ver. 1.30 or later)		BFM #14108	BFM #14308	Positioning parameters
Deceleration time 2 (Ver. 1.30 or later)		BFM #14110	BFM #14310	Positioning parameters

*2. Set approximate S-shaped acceleration/deceleration or trapezoidal acceleration/deceleration in "acceleration/deceleration mode."

6. Linear interpolation operation

If the time necessary for the travel distance (target address 1) is smaller than the acceleration/deceleration time, the actual operation speed does not reach the command speed.

7. Linear interpolation operation (interrupt stop)

If the time necessary for the travel distance (target address 1) is smaller than the deceleration time, the output pulses stop at the deceleration target address 1 (target address 1). If the travel distance is zero, the operation immediately stops at the interrupt input (INT0) ON.

8. Interpolation operation (during continuous pass operation)

If the travel distance is small and the travel time from the starting point to the end point is shorter than the interpolation time constant, the operation temporarily stops, and then shifts to the next interpolation operation.

→ For cautions on continuous pass operation, refer also to Subsection 7.11.4

7.11.3 Setting of interpolation operation, pulse rate and feed rate

1. Linear Interpolation Operation (including the Interrupt Stop)

When setting a different pulse rate/feed rate (X-axis) and pulse rate/feed rate (Y-axis) during interpolation operation

- If the 20SSC-H version is earlier than Ver.1.20
Set ratios that are the same for the pulse rate to the feed rate for the X-axis and the Y-axis.
When the ratios are different, the actual speed does not match the set speed.
- If the 20SSC-H version is Ver.1.20 or later
Set the interpolation gear ratio selection function in the X- axis, Y-axis.

2. Circular Interpolation Operation

When setting a different pulse rate/feed rate (X-axis) and pulse rate/feed rate (Y-axis) during interpolation operation

- If the 20SSC-H version is earlier than Ver.1.20
Circular arcs are deformed if the ratio of the pulse rate to the feed rate differs between the X-axis and the Y-axis. Set ratios that are the same for the pulse rate to the feed rate for the X-axis and the Y-axis.
- If the 20SSC-H version is Ver.1.20 or later
Set the interpolation gear ratio selection function in the X- axis, Y-axis if the ratio of the pulse rate to the feed rate differs between the X-axis and the Y-axis.

Interpolation gear ratio selection (The 20SSC-H Ver. 1.20 or later supports this method)

Use the interpolation gear ratio selection function when setting different pulse rate/feed rate (X-axis) and pulse rate/feed rate (Y-axis) during interpolation operation.

Sets the interpolation gear ratio selection

To apply this function, set [BFM # 14002 b14] in the operation parameter 2 to ON (X-axis, Y-axis).

	BFM Number		Data type
	X-axis	Y-axis	
Pulse rate	BFM #14005,#14004	BFM #14205,#14204	Positioning parameters
Feed rate	BFM #14007,#14006	BFM #14207,#14206	Positioning parameters
Interpolation gear ratio selection	Operation parameter 2	BFM #14002 b14	Positioning parameters

7.11.4 Cautions on continuous pass operation

When the following interpolation operation exists in continuous pass operation, the system does not perform continuous pass operation.

- 1) Interpolation operation conditions which disables continuous pass operation
 - a) Interpolation operation in which the m code is set in After mode
 - b) Interpolation operation in which the travel time is 50 ms or less
 - c) Interpolation operation in which the travel time is "Interpolation time constant × 2" or less
- 2) System operation when continuous pass operation is disabled

Condition	Operation
Interpolation operation in which the m code is set in After mode	The system waits for the m code OFF command. When the m code OFF command is set to ON, the system operation will transition to the next table.
Interpolation operation in which the travel time is 50 ms or less	The system does not perform continuous pass operation (in which inflection points make a smooth curve), but the system operation will transition to the next table when positioning is completed. (Refer to the following figure.)
Interpolation operation in which the travel time is "Interpolation time constant × 2" or less	

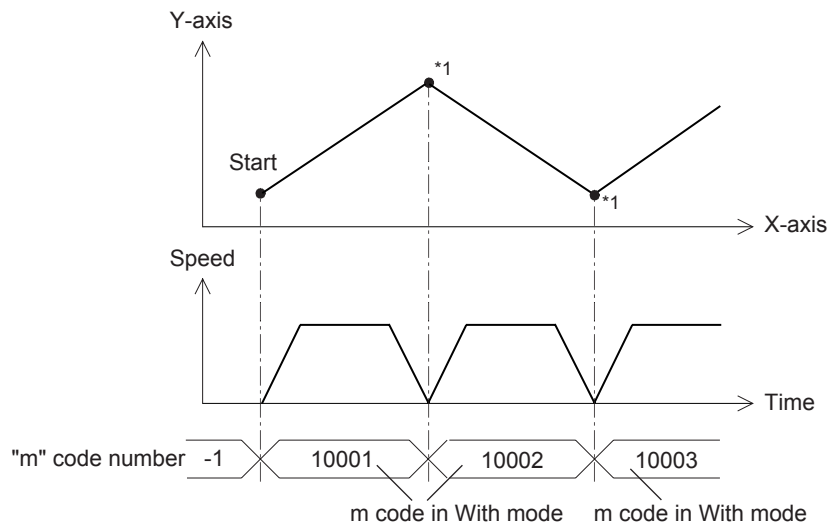

- *1. When setting the m code in With mode in a 20SSC-H earlier than Ver.1.30, the system waits for the m code OFF command, the m code OFF command is needed for the system operation to transition to the next table.

7.11.5 Cautions when acceleration/deceleration time is changed during positioning operation

Select the acceleration/deceleration time before starting positioning operation.

If the acceleration/deceleration time selection is changed during positioning operation, the system will perform the following operation depending on the operation status.

→ **For selection of the acceleration/deceleration time, refer to Section 7.7**

- When the acceleration/deceleration time selection is changed during acceleration/deceleration
The system will operate using the new acceleration/deceleration time. However, attention should be paid to positioning operation because the acceleration time setting may not be changed with the intended timing.
- When the acceleration/deceleration time selection is changed during positioning operation at the operation speed
The system will operate using the new deceleration time. If the acceleration/deceleration time selection is changed just before start of deceleration, the deceleration time setting may not be changed.
If the time needed for the remaining travel distance is shorter than the time needed for deceleration after a change, the pulse output may decrease suddenly during deceleration.
For 2-speed positioning operation, interrupt 2-speed constant quantity feed, variable speed operation and multi-speed operation, the system will operate using the new acceleration/deceleration time.
- When the acceleration/deceleration time selection is changed during deceleration
The system will operate using the deceleration time before the change. However, for 2-speed positioning operation, interrupt 2-speed constant quantity feed, variable speed operation and multi-speed operation, the system will operate using the changed acceleration/deceleration time.

		BFM Number		Data type
		X-axis	Y-axis	
Acceleration/deceleration time change command (Ver. 1.30 or later)	Operation command 2	BFM #519 b5	BFM #619 b5	Control data
Acceleration time		BFM #14018	BFM #14218	Positioning parameters
Deceleration time		BFM #14020	BFM #14220	Positioning parameters
Acceleration time 2 (Ver. 1.30 or later)		BFM #14108	BFM #14308	Positioning parameters
Deceleration time 2 (Ver. 1.30 or later)		BFM #14110	BFM #14310	Positioning parameters

8. Manual Control

8.1 Mechanical Zero Return Control

8.1.1 Outline of mechanical zero return control

1. Types of mechanical zero return operation

The mechanical zero return method for the 20SSC-H includes the following three variations (four modes).

→ For the parameters, control data and monitor data, refer to Chapter 11

- DOG type mechanical zero return (1 mode)
The position after stopping from the DOG signal with the zero signal of the servomotor becomes the zero-point.
→ For details on the DOG type mechanical zero return, refer to Subsection 8.1.2
- Data-set type mechanical zero return (1 mode)
The position after moving with the JOG operation or manual pulse generator is defined as the zero-point.
→ For details on the data-set type mechanical zero return, refer to Subsection 8.1.3
- Stopper type mechanical zero return (2 modes)
The stopper position is defined as the zero-point.
 - Stopper type (1)
This mechanical zero return method uses the DOG signal and stopper.
High speed travel is possible up to the DOG signal, thus reducing the time for mechanical zero return
→ For details of the stopper type (1) mechanical zero return operation, refer to Subsection 8.1.4
 - Stopper type (2)
This mechanical zero return method (creep speed only) uses only the stopper.
→ For details of the stopper type (2) mechanical zero return operation, refer to Subsection 8.1.5

2. Mechanical zero return operation

The mechanical zero return operation varies according to the zero return mode. For details, refer to the following.

→ For details on the DOG type mechanical zero return, refer to Subsection 8.1.2

→ For details on the data-set type mechanical zero return, refer to Subsection 8.1.3

→ For details of the stopper type (1) mechanical zero return operation, refer to Subsection 8.1.4

→ For details of the stopper type (2) mechanical zero return operation, refer to Subsection 8.1.5

- 1) Turn the mechanical zero return command from OFF to ON to execute mechanical zero return.
- 2) After calibrating the zero-point, the current address is set as the mechanical zero-point address in the positioning parameters.
- 3) The zero return complete flag turns ON.

		BFM Number		Data type
		X-axis	Y-axis	
Mechanical zero return command	Operation command 1	BFM #518 b6	BFM #618 b6	Control data
Simultaneous START flag	Operation command 1	BFM #518 b10		Control data
Mechanical zero-point address		BFM #14029,#14028	BFM #14229,#14228	Positioning parameters
Zero return mode		BFM #14031	BFM #14231	Positioning parameters
Current address (user)		BFM #1,#0	BFM #101,#100	Monitor data
Current address (pulse)		BFM #3,#2	BFM #103,#102	Monitor data
Zero return complete	Status information	BFM #28 b3	BFM #128 b3	Monitor data
Zero phase passed	Servo status	BFM #63 b0	BFM #163 b0	Monitor data
Function selection C-4	Servo parameters (Advanced setting)	BFM #15080	BFM #15280	Servo parameters

3. Zero return complete flag

The zero return complete flag turns ON (sets) when the mechanical zero return operation finishes. It turns OFF (resets) when reactivating the mechanical zero return command, or when turning the power OFF.

8.1.2 DOG type mechanical zero return

With the DOG type mechanical zero return, the 20SSC-H sets the zero-point position after the module stops with a near-point DOG signal and servo motor zero-point signal. Use the DOG search function to execute the DOG type mechanical zero return arbitrarily.

- For the zero return interlock function, refer to Subsection 7.9.10
- For details on the table operation, refer to Chapter 10
- For the parameters, control data and monitor data, refer to Chapter 11

1. Operation

Zero return starts as follows, at the rising edge (OFF → ON) of the mechanical zero return command.

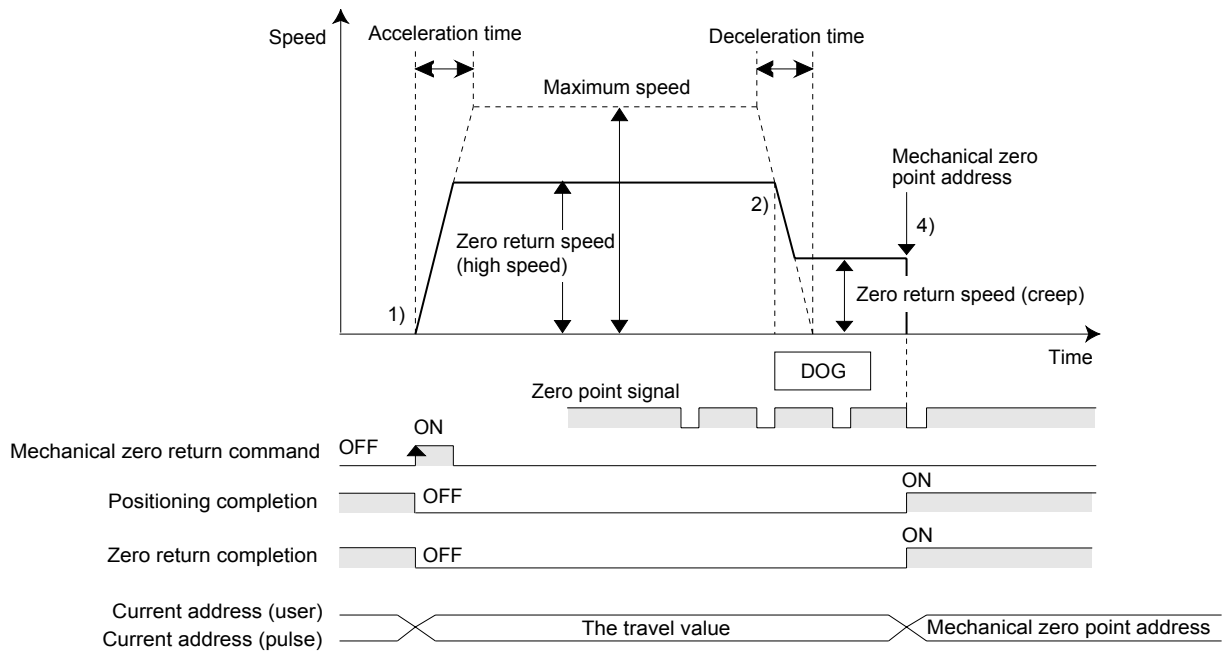

- 1) At the rising edge (OFF → ON) of the mechanical zero return command, the work piece moves in the zero return direction at the zero return speed (high speed).
- 2) At the DOG input, the 20SSC-H decelerates the work piece to the zero return speed (creep).
- 3) The 20SSC-H counts zero-point signals after passing the zero-point signal count start timing.
- 4) After counting the specified number (zero-point signal numbers), the 20SSC-H stops the work piece.
- 5) After calibrating the zero-point, the current address is set as the mechanical zero-point address in positioning parameters.
- 6) The 20SSC-H turns the positioning completion flag ON and sets (turns ON) the zero return complete flag.
→ For the parameters, control data and monitor data, refer to Chapter 11

		BFM Number		Data type
		X-axis	Y-axis	
Zero return direction	Operation parameter 1	BFM #14000 b10	BFM #14200 b10	Positioning parameters
DOG input logic (20SSC-H)	Operation parameter 1	BFM #14000 b12	BFM #14200 b12	Positioning parameters
Zero-phase signal count start timing	Operation parameter 1	BFM #14000 b13	BFM #14200 b13	Positioning parameters
Zero return interlock setting enabled/disabled	Operation parameter 2	BFM #14002 b2	BFM #14202 b2	Positioning parameters
Maximum speed		BFM #14009,#14008	BFM #14209,#14208	Positioning parameters
Acceleration time		BFM #14018	BFM #14218	Positioning parameters
Deceleration time		BFM #14020	BFM #14220	Positioning parameters
Zero return speed (high speed)		BFM #14025,#14024	BFM #14225,#14224	Positioning parameters
Zero return speed (creep)		BFM #14027,#14026	BFM #14227,#14226	Positioning parameters
Mechanical zero-point address		BFM #14029,#14028	BFM #14229,#14228	Positioning parameters
Zero signal count		BFM #14030	BFM #14230	Positioning parameters

- 1 Introduction
- 2 System configuration
- 3 Specifications
- 4 Installation
- 5 Wiring
- 6 Memory Config. and data operation
- 7 Before starting positioning operation
- 8 Manual control
- 9 Positioning Control
- 10 Table Operation

		BFM Number		Data type
		X-axis	Y-axis	
DOG type mechanical zero return operation	Zero return mode	BFM #14031 = K0	BFM #14231 = K0	Positioning parameters
Use/ not use FLS, RLS signal servo amplifier	External input selection	BFM #14044 b0	BFM #14244 b0	Positioning parameters
Use/ not use DOG signal of servo amplifier	External input selection	BFM #14044 b1	BFM #14244 b1	Positioning parameters
FLS/RLS signal logic of servo amplifier	External input selection	BFM #14044 b8	BFM #14244 b8	Positioning parameters
DOG signal logic of servo amplifier	External input selection	BFM #14044 b9	BFM #14244 b9	Positioning parameters
Acceleration time 2 (Ver. 1.30 or later)		BFM #14108	BFM #14308	Positioning parameters
Deceleration time 2 (Ver. 1.30 or later)		BFM #14110	BFM #14310	Positioning parameters
X-DOG		-	-	Input terminal (20SSC-H)
Y-DOG		-	-	Input terminal (20SSC-H)
X-axis forward rotation limit 1 (LSF)		-	-	Input terminal (PLC)
X-axis reverse rotation limit 1 (LSR)		-	-	Input terminal (PLC)
Y-axis forward rotation limit 1 (LSF)		-	-	Input terminal (PLC)
Y-axis reverse rotation limit 1 (LSR)		-	-	Input terminal (PLC)
X-axis forward rotation limit 2 (FLS)		-	-	External signal (servo amplifier)
X-axis reverse rotation limit 2 (RLS)		-	-	External signal (servo amplifier)
Y-axis forward rotation limit 2 (FLS)		-	-	External signal (servo amplifier)
Y-axis reverse rotation limit 2 (RLS)		-	-	External signal (servo amplifier)
Forward rotation limit (LSF) [Forward rotation limit 1]	Operation command 1	BFM #518 b2	BFM #618 b2	Control data
Reverse rotation limit (LSR) [Reverse rotation limit 1]	Operation command 1	BFM #518 b3	BFM #618 b3	Control data
Mechanical zero return command	Operation command 1	BFM #518 b6	BFM #618 b6	Control data
Simultaneous START flag	Operation command 1	BFM #518 b10		Control data
Acceleration/deceleration time change command (Ver. 1.30 or later)	Operation command 2	BFM #519 b5	BFM #619 b5	Control data
Current address (user)		BFM #1,#0	BFM #101,#100	Monitor data
Current address (pulse)		BFM #3,#2	BFM #103,#102	Monitor data
Zero return complete	Status information	BFM #28 b3	BFM #128 b3	Monitor data
Positioning completion	Status information	BFM #28 b6	BFM #128 b6	Monitor data
Zero phase passed	Servo status	BFM #63 b0	BFM #163 b0	Monitor data
Function selection C-4	Servo parameters (Advanced setting)	BFM #15080	BFM #15280	Servo parameters

Note

- The zero return command is not accepted if the zero-point pass signal servo status is OFF. Before executing zero return, be sure to rotate the servomotor at least once to turn the zero-point pass signal ON. The zero-point pass signal turns ON when the motor passes the motor reference position signal (Z-phase).
To execute zero return immediately after power-on, specify "1: Motor Z-phase pass unnecessary after power-on" (default setting) at servo parameter function selection C-4. With this setting, the zero-point pass signal turns ON even if the motor does not pass the zero-point (Z-phase).
- With the simultaneous start flag ON, the X-axis mechanical zero return command simultaneously starts the X and Y-axes mechanical zero return operation.
(The 20SSC-H ignores the Y-axis mechanical zero return command.)

Precautions when setting the DOG input logic

An incorrect DOG input logic state will disable the correct operation. Pay close attention when changing the initial setting value.

2. DOG search function

The zero return with DOG search is executable with forward/reverse rotation limit. At this time, the zero return action varies in the following way according to the zero return starting position.

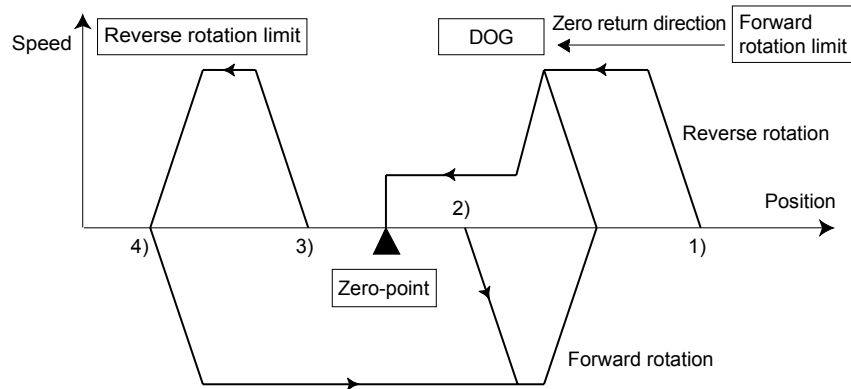

- 1) If the starting position is in the near point signal OFF area (before passing DOG)
 - a) Operation is conducted in the zero return direction at the zero return speed (high speed).
 - b) After the DOG detection, deceleration to the zero return speed (creep) begins.
 - c) After detecting the zero-point signal count start timing, the zero-point signal is counted.
 - d) After counting the specified number of zero-point signals, the travel is stopped.
- 2) If the starting position is in the near point signal ON area
 - a) Operation is conducted at the zero return speed (high speed) in the direction opposite to the zero return direction.
 - b) Upon the DOG detection (escaping from the DOG), deceleration to stop begins.
 - c) Operation is conducted in the zero return direction at the zero return speed (high speed).
 - d) After the DOG is detected, deceleration to the zero return speed (creep) begins.
 - e) After counting the zero-point signal, the 20SSC-H stops.
- 3) If the starting position is in the near point signal OFF area (after passing DOG)
 - a) Operation is conducted in the zero return direction at the zero return speed (high speed).
 - b) Upon the forward/reverse rotation limit, the travel decelerates to stop.
 - c) Operation is conducted in the direction opposite to the zero return direction at the zero return speed (high speed).
 - d) Upon the DOG detection (escaping from the DOG), the travel decelerates to stop. The operation begins again in the zero return direction at the zero return speed (high speed).
 - e) After DOG detection, the travel decelerates to the zero return speed (creep speed) and, after counting the zero-point signal, the 20SSC-H stops.
- 4) When the limit switch (forward or reverse rotation limit) in the zero return direction turns ON
 - a) The operation is conducted in the direction opposite to the zero return direction at the zero return speed (high speed).
 - b) Upon the DOG detection (escaping from the DOG), the travel decelerates to stop.
 - c) The operation is conducted again in the zero return direction at the zero return speed (high speed).
 - d) Upon the DOG detection, the travel decelerates to the zero return speed (creep speed) and after counting the zero-point signal, the 20SSC-H stops.

Note

When forward or reverse rotation limit turns ON, or forward/reverse rotation limit error (error code:4004) occurred, execute mechanical zero return after releasing the error by the error reset.

Caution

- If the DOG is not detected during the DOG search operations, a limit error occurs.
- When using a DOG search function, provide the forward/reverse rotation limit in either the servo amplifier or the PLC.

→ For the forward/reverse rotation limit, refer to Section 7.3

3. Changing the zero return speed

Use the override function or operation speed change function to change the zero return speed (high speed). However, the speed does not change when the operation speed change disable flag is ON.

→ For the override function, refer to Subsection 7.6.1

→ For the operation speed change function, refer to Subsection 7.6.2

8.1.3 Data-set type mechanical zero return

Use the data-set type mechanical zero return procedure to set the position moved by JOG or manual pulse generator operation, as a zero-point. Therefore the work piece does not travel at the mechanical zero return command.

This zero return procedure is frequently used for equipment without a DOG, or for transfer lines without a mechanical zero-point.

→ For the zero return interlock function, refer to Subsection 7.9.10

→ For details on the table operation, refer to Chapter 10

→ For the parameters, control data and monitor data, refer to Chapter 11

Operation

- 1) With JOG or manual pulse generator operation, the work piece is moved to the desired zero-point.
→ For jog operation, refer to Section 8.2
→ For manual pulse generator operation, refer to Section 8.3
- 2) Turn ON the mechanical zero return command.
- 3) The current address is set as the mechanical zero-point address in the positioning parameters.
- 4) The 20SSC-H turns the zero return complete flag to ON.
In the data-set type mechanical zero return mode, the positioning completion flag does not turn ON.
→ For the parameters, control data and monitor data, refer to Chapter 11

		BFM Number		Data type
		X-axis	Y-axis	
Zero return interlock setting enabled/disabled	Operation parameter 2	BFM #14002 b2	BFM #14202 b2	Positioning parameters
Mechanical zero-point address		BFM #14029,#14028	BFM #14229,#14228	Positioning parameters
Data-set type mechanical zero return operation	Zero return mode	BFM #14031 = K1	BFM #14231 = K1	Positioning parameters
Forward rotation JOG	Operation command 1	BFM #518 b4	BFM #618 b4	Control data
Reverse rotation JOG	Operation command 1	BFM #518 b5	BFM #618 b5	Control data
Mechanical zero return command	Operation command 1	BFM #518 b6	BFM #618 b6	Control data
Simultaneous START flag	Operation command 1	BFM #518 b10		Control data
Manual pulse generator operation	Operation pattern selection	BFM #520 b6	BFM #620 b6	Control data
Current address (user)		BFM #1,#0	BFM #101,#100	Monitor data
Current address (pulse)		BFM #3,#2	BFM #103,#102	Monitor data
Zero return complete	Status information	BFM #28 b3	BFM #128 b3	Monitor data
Zero phase passed	Servo status	BFM #63 b0	BFM #163 b0	Monitor data
Function selection C-4	Servo parameters (Advanced setting)	BFM #15080	BFM #15280	Servo parameters

Note

- The zero return command is not accepted if the zero-point pass signal servo status is OFF.
Before executing zero return, be sure to rotate the servomotor at least once to turn the zero-point pass signal ON. The zero-point pass signal turns ON when the motor passes the motor reference position signal (Z-phase).
To execute zero return immediately after power-on, specify "1: Motor Z-phase pass unnecessary after power-on" (default setting) at servo parameter function selection C-4. With this setting, the zero-point pass signal turns ON even if the motor does not pass the zero-point (Z-phase).
- With the simultaneous start flag ON, the X-axis mechanical zero return command simultaneously starts the X and Y-axes mechanical zero return operation.
(The 20SSC-H ignores the Y-axis mechanical zero return command.)

8.1.4 Stopper type (1) mechanical zero return operation

This mechanical zero return method uses the DOG signal and stopper.

High speed travel is possible up to the DOG signal, thus reducing the time for mechanical zero return.

→ For the zero return interlock function, refer to Subsection 7.9.10

→ For details on the table operation, refer to Chapter 10

→ For the parameters, control data and monitor data, refer to Chapter 11

1. Operation

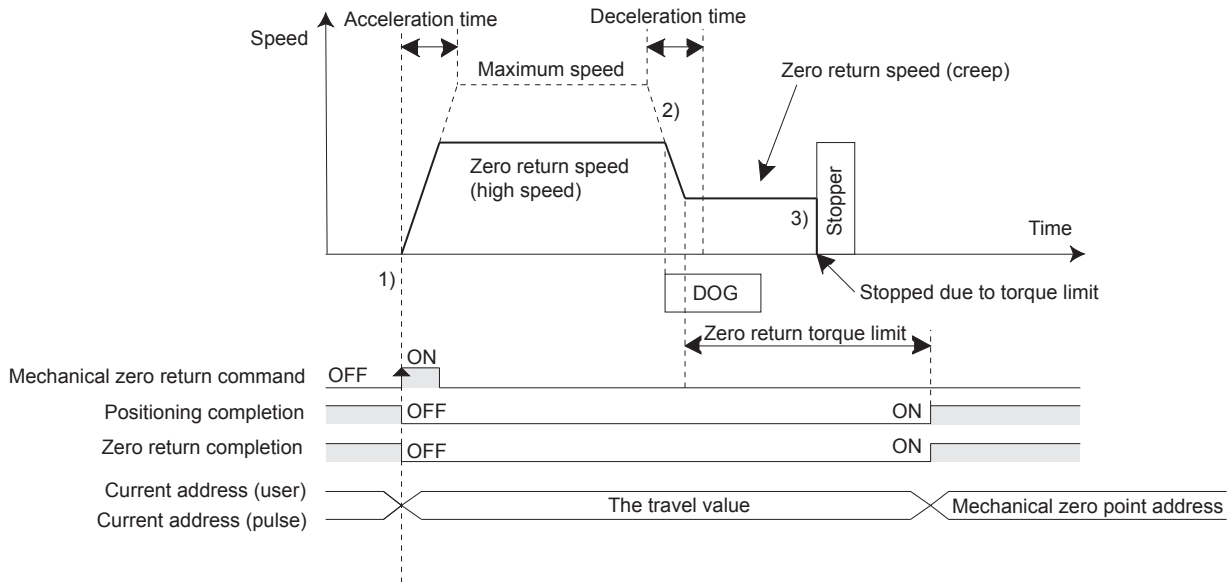

- 1) At the rising edge (OFF → ON) of the mechanical zero return command, the work piece moves in the zero return direction at the zero return speed (high speed).
- 2) At the DOG input, the 20SSC-H decelerates the work piece to the zero return speed (creep).
- 3) The work piece hits the stopper, and the work piece stops when the servomotor torque reaches the zero return torque limit value.
- 4) After the stop point, the current address is set as the mechanical zero-point address in the positioning parameters.
- 5) The 20SSC-H turns the positioning completion flag ON and sets (turns ON) the zero return complete flag.

→ For the parameters, control data and monitor data, refer to Chapter 11

		BFM Number		Data type
		X-axis	Y-axis	
Zero return direction	Operation parameter 1	BFM #14000 b10	BFM #14200 b10	Positioning parameters
DOG input logic (20SSC-H)	Operation parameter 1	BFM #14000 b12	BFM #14200 b12	Positioning parameters
Zero return interlock setting enabled/disabled	Operation parameter 2	BFM #14002 b2	BFM #14202 b2	Positioning parameters
Maximum speed		BFM #14009,#14008	BFM #14209,#14208	Positioning parameters
Acceleration time		BFM #14018	BFM #14218	Positioning parameters
Deceleration time		BFM #14020	BFM #14220	Positioning parameters
Zero return speed (high speed)		BFM #14025,#14024	BFM #14225,#14224	Positioning parameters
Zero return speed (creep)		BFM #14027,#14026	BFM #14227,#14226	Positioning parameters
Mechanical zero-point address		BFM #14029,#14028	BFM #14229,#14228	Positioning parameters
Stopper type (1) mechanical zero return operation	Zero return mode	BFM #14031 = K2	BFM #14231 = K2	Positioning parameters
Zero return torque limit value		BFM #14040	BFM #14240	Positioning parameters
Use/ not use DOG signal of servo amplifier	External input selection	BFM #14044 b1	BFM #14244 b1	Positioning parameters

		BFM Number		Data type
		X-axis	Y-axis	
DOG signal logic of servo amplifier	External input selection	BFM #14044 b9	BFM #14244 b9	Positioning parameters
Acceleration time 2 (Ver. 1.30 or later)		BFM #14108	BFM #14308	Positioning parameters
Deceleration time 2 (Ver. 1.30 or later)		BFM #14110	BFM #14310	Positioning parameters
X-DOG		-	-	Input terminal (20SSC-H)
Y-DOG		-	-	Input terminal (20SSC-H)
Mechanical zero return command	Operation command 1	BFM #518 b6	BFM #618 b6	Control data
Simultaneous START flag	Operation command 1	BFM #518 b10		Control data
Acceleration/deceleration time change command (Ver. 1.30 or later)	Operation command 2	BFM #519 b5	BFM #619 b5	Control data
Current address (user)		BFM #1,#0	BFM #101,#100	Monitor data
Current address (pulse)		BFM #3,#2	BFM #103,#102	Monitor data
Zero return complete	Status information	BFM #28 b3	BFM #128 b3	Monitor data
Positioning completion	Status information	BFM #28 b6	BFM #128 b6	Monitor data
Zero phase passed	Servo status	BFM #63 b0	BFM #163 b0	Monitor data
Function selection C-4	Servo parameters (Advanced setting)	BFM #15080	BFM #15280	Servo parameters

Note

- The zero return command is not accepted if the zero-point pass signal servo status is OFF. Before executing zero return, be sure to rotate the servomotor at least once to turn the zero-point pass signal ON. The zero-point pass signal turns ON when the motor passes the motor reference position signal (Z-phase).
To execute zero return immediately after power-on, specify "1: Motor Z-phase pass unnecessary after power-on" (default setting) at servo parameter function selection C-4. With this setting, the zero-point pass signal turns ON even if the motor does not pass the zero-point (Z-phase).
- With the simultaneous start flag ON, the X-axis mechanical zero return command simultaneously starts the X and Y-axes mechanical zero return operation.
(The 20SSC-H ignores the Y-axis mechanical zero return command.)

DOG position

Install the DOG at a position far enough from the stopper for the work piece to decelerate to the zero-point return speed (creep).

2. Changing the zero return speed

Use the override function or operation speed change function to change the zero return speed (high speed). However, the speed does not change when the operation speed change disable flag is ON.

→ For the override function, refer to Subsection 7.6.1

→ For the operation speed change function, refer to Subsection 7.6.2

8.1.5 Stopper type (2) Mechanical zero return operation

This mechanical zero return method (creep speed only) uses only the stopper.

→ For the zero return interlock function, refer to Subsection 7.9.10

→ For details on the table operation, refer to Chapter 10

→ For the parameters, control data and monitor data, refer to Chapter 11

1. Operation

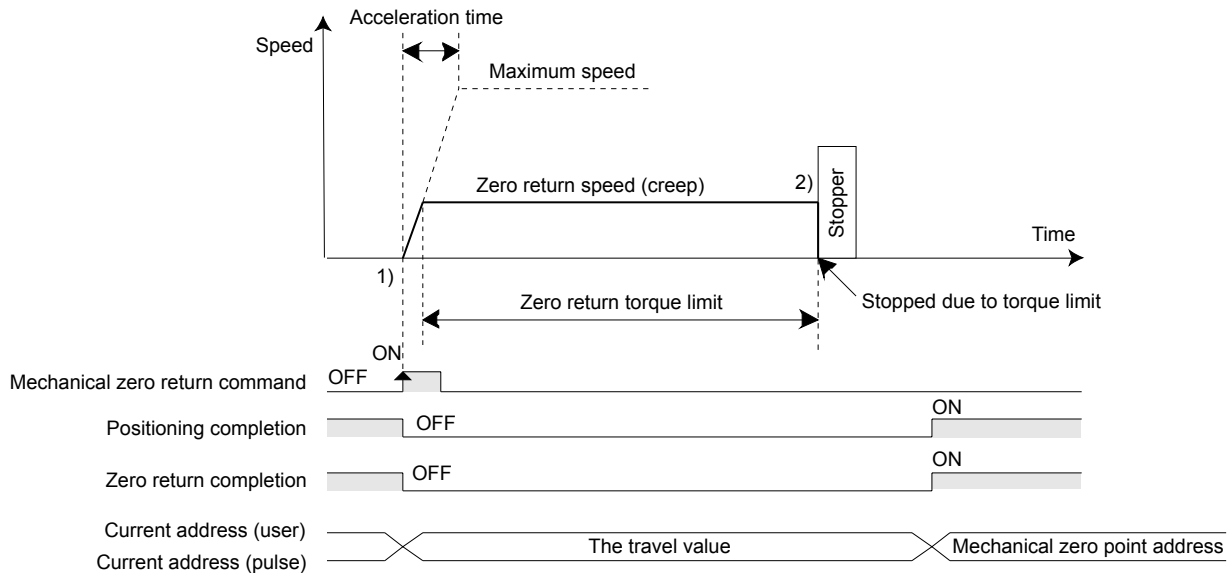

- 1) Upon the rising edge (OFF → ON) of the mechanical zero return command, the work piece moves in the zero return direction at the zero return speed (creep).
- 2) After the work piece hits the stopper, the work piece stops when the servomotor torque reaches the zero return torque limit value.
- 3) After the stop point, the current address is set as the mechanical zero-point address in the positioning parameters.
- 4) The 20SSC-H turns the positioning completion flag ON and sets (turns ON) the zero return complete flag.
→ For the parameters, control data and monitor data, refer to Chapter 11

		BFM Number		Data type
		X-axis	Y-axis	
Zero return direction	Operation parameter 1	BFM #14000 b10	BFM #14200 b10	Positioning parameters
Zero return interlock setting enabled/disabled	Operation parameter 2	BFM #14002 b2	BFM #14202 b2	Positioning parameters
Maximum speed		BFM #14009,#14008	BFM #14209,#14208	Positioning parameters
Acceleration time		BFM #14018	BFM #14218	Positioning parameters
Zero return speed (Creep)		BFM #14027,#14026	BFM #14227,#14226	Positioning parameters
Mechanical zero-point address		BFM #14029,#14028	BFM #14229,#14228	Positioning parameters
Stopper type (2) Mechanical zero return operation	Zero return mode	BFM #14031 = K3	BFM #14231 = K3	Positioning parameters
Zero return torque limit value		BFM #14040	BFM #14240	Positioning parameters
Acceleration time 2 (Ver. 1.30 or later)		BFM #14108	BFM #14308	Positioning parameters
Mechanical zero return command	Operation command 1	BFM #518 b6	BFM #618 b6	Control data
Simultaneous START flag	Operation command 1	BFM #518 b10		Control data
Acceleration/deceleration time change command (Ver. 1.30 or later)	Operation command 2	BFM #519 b5	BFM #619 b5	Control data
Current address (user)		BFM #1,#0	BFM #101,#100	Monitor data

- 1 Introduction
- 2 System configuration
- 3 Specifications
- 4 Installation
- 5 Wiring
- 6 Memory Config. and data operation
- 7 Before starting positioning operation
- 8 Manual control
- 9 Positioning Control
- 10 Table Operation

		BFM Number		Data type
		X-axis	Y-axis	
Current address (pulse)		BFM #3,#2	BFM #103,#102	Monitor data
Zero return complete	Status information	BFM #28 b3	BFM #128 b3	Monitor data
Positioning completion	Status information	BFM #28 b6	BFM #128 b6	Monitor data
Zero phase passed	Servo status	BFM #63 b0	BFM #163 b0	Monitor data
Function selection C-4	Servo parameters (Advanced setting)	BFM #15080	BFM #15280	Servo parameters

Note

- The zero return command is not accepted if the zero-point pass signal servo status is OFF.
Before executing zero return, be sure to rotate the servomotor at least once to turn the zero-point pass signal ON. The zero-point pass signal turns ON when the motor passes the motor reference position signal (Z-phase).
To execute zero return immediately after power-on, specify "1: Motor Z-phase pass unnecessary after power-on" (default setting) at servo parameter function selection C-4. With this setting, the zero-point pass signal turns ON even if the motor does not pass the zero-point (Z-phase).
- With the simultaneous start flag ON, the X-axis mechanical zero return command simultaneously starts the X and Y-axes mechanical zero return operation.
(The 20SSC-H ignores the Y-axis mechanical zero return command.)

8.2 JOG Operation

8.2.1 Outline of JOG operation

Forward pulses are output in the forward JOG mode, while reverse pulses are output in the reverse JOG mode.

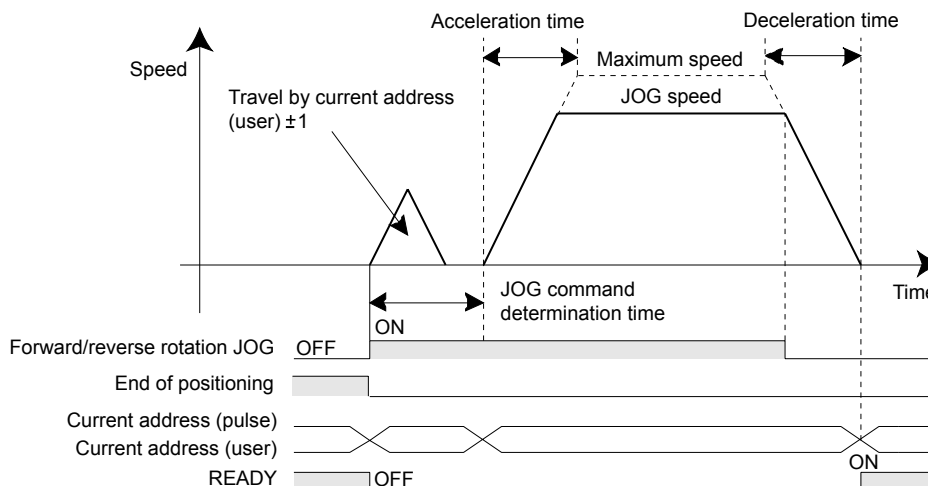

- The work piece stops when a JOG operation with an opposite direction is activated during a FWD/RVS JOG operation and begins again when a FWD or RVS direction is turned OFF.
- If the FWD/RVS JOG is reactivated while decelerating during the FWD/RVS JOG operation, the 20SSC-H will re-accelerate to continue the operation.
- If the forward/reverse rotation limit 1 (2) turns ON, a limit error occurs after decelerating to stop.
In this case, a JOG operation in the opposite direction saves the work piece from the limit switch ON-state.
→ For the parameters, control data and monitor data, refer to Chapter 11

	BFM Number		Data type	
	X-axis	Y-axis		
Maximum speed	BFM #14009,#14008	BFM #14209,#14208	Positioning parameters	
Acceleration time	BFM #14018	BFM #14218	Positioning parameters	
Deceleration time	BFM #14020	BFM #14220	Positioning parameters	
JOG speed	BFM #14013,#14012	BFM #14213,#14212	Positioning parameters	
JOG command determination time	BFM #14014	BFM #14214	Positioning parameters	
Acceleration time 2 (Ver. 1.30 or later)	BFM #14108	BFM #14308	Positioning parameters	
Deceleration time 2 (Ver. 1.30 or later)	BFM #14110	BFM #14310	Positioning parameters	
Forward rotation JOG	Operation command 1	BFM #518 b4	BFM #618 b4	Control data
Reverse rotation JOG	Operation command 1	BFM #518 b5	BFM #618 b5	Control data
Simultaneous START flag	Operation command 1	BFM #518 b10		Control data
Acceleration/deceleration time change command (Ver. 1.30 or later)	Operation command 2	BFM #519 b5	BFM #619 b5	Control data
Current address (user)		BFM #1,#0	BFM #101,#100	Monitor data
Current address (pulse)		BFM #3,#2	BFM #103,#102	Monitor data

- 1 Introduction
- 2 System configuration
- 3 Specifications
- 4 Installation
- 5 Wiring
- 6 Memory Config. and data operation
- 7 Before starting positioning operation
- 8 Manual control
- 9 Positioning Control
- 10 Table Operation

Note

- Inching operation (JOG determination time)
To perform inching operation, specify the JOG determination time.
 - If the forward/reverse JOG activation time is within the JOG command determination time, a pulse string equivalent to ± 1 (user unit) is output at the current address to operate the inching.
 - If the forward/reverse rotation JOG activation time is equal to or larger than the JOG command determination time, pulse strings are output continuously.
 - If the JOG command determination time is 0ms, the travel equivalent to ± 1 at the current address (user) is not executed. Continuous operation is executed from the first point.
- If the simultaneous START flag turns ON, the simultaneous JOG operation in the X- and Y-axes starts at an X-axis JOG command.(The Y-axis JOG command is ignored.)
At the X-axis JOG command OFF, the 20SSC-H stops the X and Y-axes JOG operation.

8.2.2 Changing the speed during JOG operation

When changing the jog speed during jog operation, use the operation speed change function or override setting. If the jog speed is changed using the positioning parameters, the jog speed will not be changed during the current jog operation.

When changing positioning parameters

Even if the positioning parameters are changed (updated), the jog operation speed will not be changed during the current jog operation. The system will adopt the changed jog speed from a jog operation started after the jog speed change. For enabling the jog speed (positioning parameters) changed in a sequence program, it is necessary to set to ON from OFF the positioning parameter enable command.

Accordingly, when changing the jog speed during operation, use the operation speed change function or override setting.

→ For update of positioning parameters, refer to Subsection 7.1.7

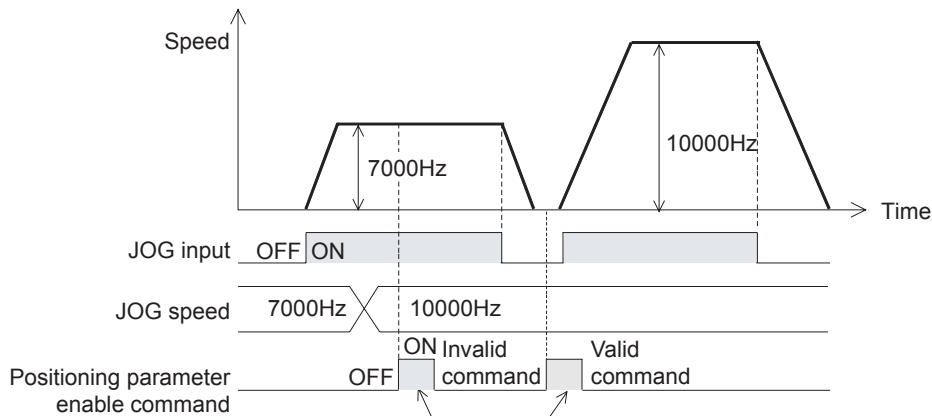

Switch the positioning parameter enable command from OFF to ON when the target axis is not performing positioning operation. If it is switched from OFF to ON while the target axis is performing positioning operation, the changed positioning parameter is invalid.

		BFM Number		Data type
		X-axis	Y-axis	
Forward rotation JOG	Operation command 1	BFM #518 b4	BFM #618 b4	Control data
Reverse rotation JOG	Operation command 1	BFM #518 b5	BFM #618 b5	Control data
Positioning parameter enable command	Operation command 2	BFM #519 b4	BFM #619 b4	Control data
JOG speed		BFM #14013,#14012	BFM #14213,#14212	Positioning parameters

1. Changing the jog speed using the operation speed change function

The system does not accept a change of the operation speed when the change command in operation disabled is ON.

→ For speed change during operation using the operation speed change function, refer to Subsection 7.6.2

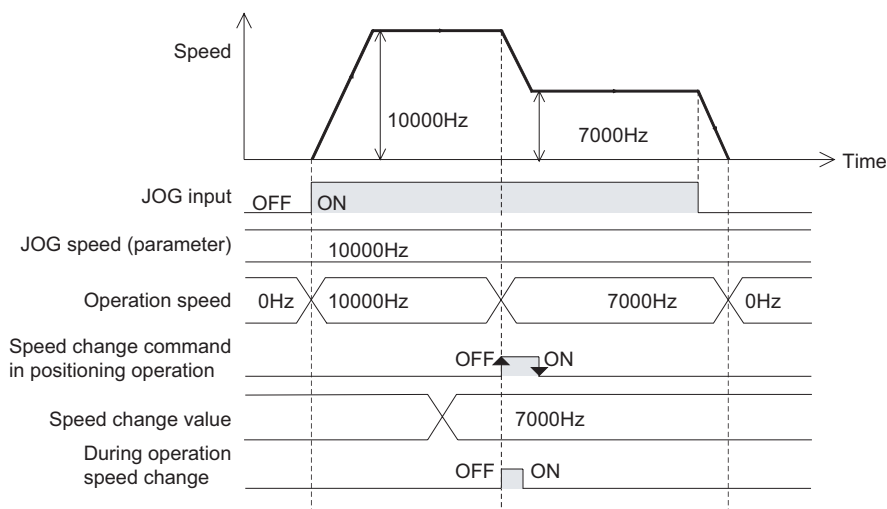

		BFM Number		Data type
		X-axis	Y-axis	
Forward rotation JOG	Operation command 1	BFM #518 b4	BFM #618 b4	Control data
Reverse rotation JOG	Operation command 1	BFM #518 b5	BFM #618 b5	Control data
Change command in operation disabled	Operation command 1	BFM #518 b12	BFM #618 b12	Control data
Speed change command in positioning operation	Operation command 1	BFM #518 b13	BFM #618 b13	Control data
Speed change value		BFM #513,#512	BFM #613,#612	Control data
Operation speed present value		BFM #11,#10	BFM #111,#110	Monitor data
Received target speed (Ver.1.20 or later)		BFM #27,#26	BFM #127,#126	Monitor data
During operation speed change	Status information	BFM #28 b13	BFM #128 b13	Monitor data
JOG speed		BFM #14013,#14012	BFM #14213,#14212	Positioning parameters

2. Changing the override setting

Use the override setting to change the ratio of the actual operation speed to the JOG speed.

→ For speed change during operation using the override function, refer to Subsection 7.6.1

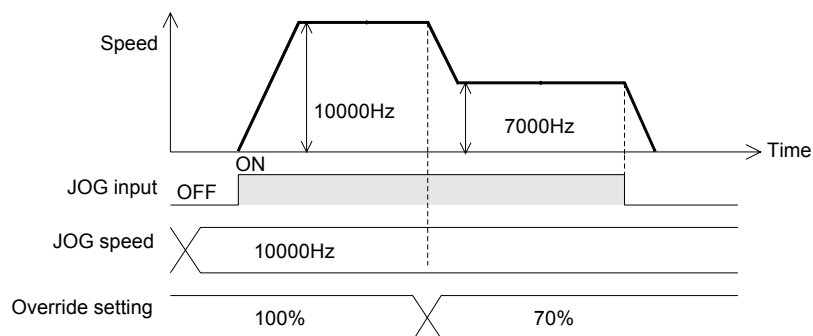

		BFM Number		Data type
		X-axis	Y-axis	
Forward rotation JOG	Operation command 1	BFM #518 b4	BFM #618 b4	Control data
Reverse rotation JOG	Operation command 1	BFM #518 b5	BFM #618 b5	Control data
Override setting		BFM #508	BFM #608	Control data
Operation speed present value		BFM #11,#10	BFM #111,#110	Monitor data
JOG speed		BFM #14013,#14012	BFM #14213,#14212	Positioning parameters

- 1 Introduction
- 2 System configuration
- 3 Specifications
- 4 Installation
- 5 Wiring
- 6 Memory Config. and data operation
- 7 Before starting positioning operation
- 8 Manual control
- 9 Positioning Control
- 10 Table Operation

8.3 Manual pulse generator operation

8.3.1 Outline of manual pulse generator operation

1. Operation

When selecting the MPG (manual pulse generator operation) in the operation patterns, the 20SSC-H operates by the MPG input.

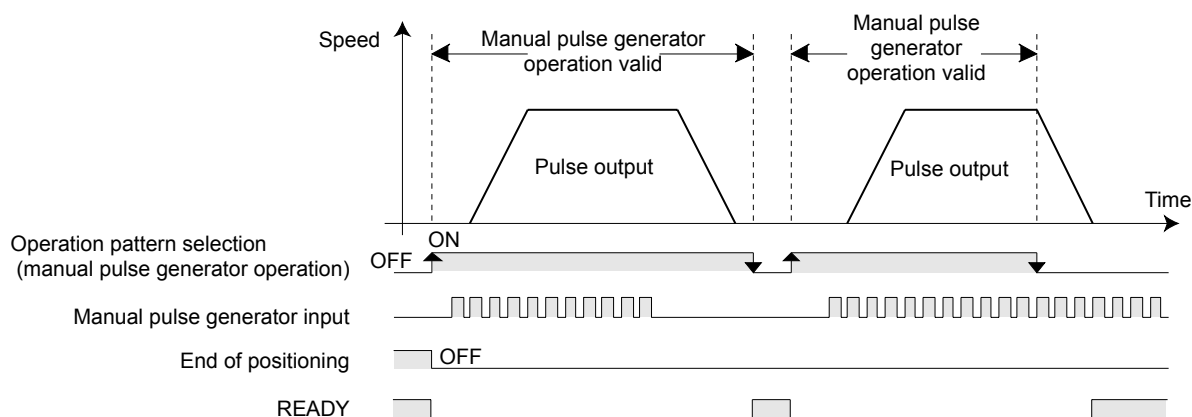

→ For the parameters, control data and monitor data, refer to Chapter 11

		BFM Number		Data type
		X-axis	Y-axis	
Manual pulse generator operation	Operation pattern selection	BFM #520 b6	BFM #620 b6	Control data
Manual pulse input magnification (numerator)		BFM #525,#524	BFM #625,#624	Control data
Manual pulse input magnification (denominator)		BFM #527,#526	BFM #627,#626	Control data
MPG response		BFM #528	BFM #628	Control data
MPG input selection		BFM #529	-	Control data
X-φA+, X-φA-, X-φB+, X-φB-		-	-	Input terminal (20SSC-H)
Y-φA+, Y-φA-, Y-φB+, Y-φB-		-	-	Input terminal (20SSC-H)
Positioning completion	Status information	BFM #28 b6	BFM #128 b6	Monitor data
Manual pulse generator input current value		BFM #13,#12	BFM #113,#112	Monitor data
Manual pulse generator input frequency		BFM #15,#14	BFM #115,#114	Monitor data

Note

- The manual pulse generator inputs the pulses in two phases (A-/B-phase).
- The positioning completion flag does not turn ON.
- When reaching the forward/reverse rotation limit during forward/reverse rotation, the work piece stops immediately and a forward/reverse rotation limit error occurs.
Perform reverse rotation if the forward rotation limit is ON, or perform forward rotation if the reverse rotation limit is ON to cancel a limit switch ON-state.

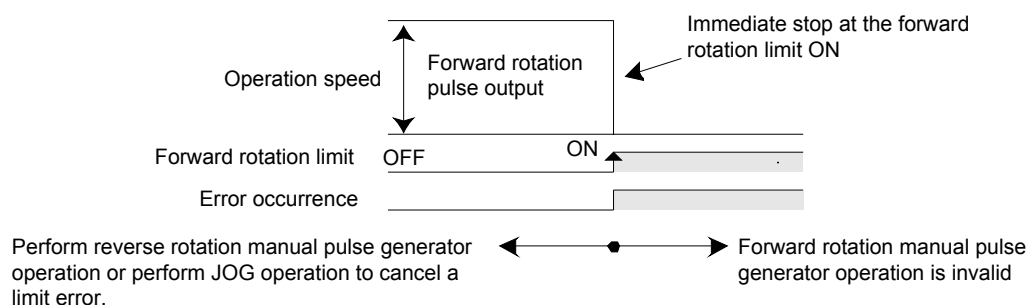

- The manual pulse generator inputs two-phase pulses (A-/B-phase) at 1 edge count.
 - Only a differential output type manual pulse generator is connectable.
 - Operation from the manual pulse generator is always counted.
 The “current MPG input value” is applicable to monitor the pulses from the MPG when the operation is not in MPG mode.

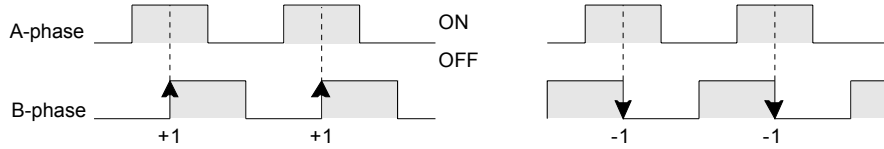

- The operation speed is proportional to the frequency of pulse strings from the manual pulse generator according to the manual pulse input magnification. In addition, the override setting is invalid.

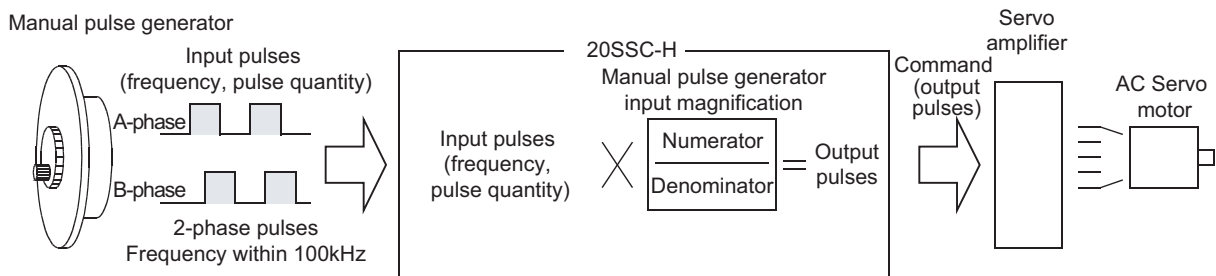

- The following equation provides output pulses to 20SSC-H.

$$\text{Input pulses (frequency, pulse quantity) from manual pulse generator} \times \text{manual pulse input magnification} = \left(\frac{\text{Manual pulse input magnification (numerator)}}{\text{Manual pulse input magnification (denominator)}} \right)$$

- If the pulse generator magnification is smaller than 1/1, one pulse is output for every multiple input pulse. Therefore, the frequency of output pulses is low while the pulse quantity is small.
- If the manual pulse input magnification is larger than 1/1, multiple pulses are output for each input pulse. Therefore, the frequency of output pulses is high while the pulse quantity is large.
- If the manual pulse input magnification is larger than 1/1, the motor rpm for each input pulse becomes larger, causing rough positioning accuracy.

1 Introduction

2 System configuration

3 Specifications

4 Installation

5 Wiring

6 Memory Config and data operation

7 Before starting positioning operation

8 Manual control

9 Positioning Control

10 Table Operation

- Pulse generator magnification response (Ver.1.10 or later)
For the relationship between the response and input pulses/output pulses, refer to the figure below.
The response setting does not affect the output pulse frequency and pulse quantity.

	BFM Number		Description
	X-axis	Y-axis	
MPG response	BFM #528	BFM #628	<p>Sets the MPG response (Ver.1.10 or later) The set value can be changed even during operation.</p> <ul style="list-style-type: none"> • If the set value is smaller, the follow-up capability of output pulses to manual pulse generator inputs is higher. • However, note that the machine may be overloaded if the speed is changed drastically. • If the set value is larger, the follow-up capability of output pulses to manual pulse generator inputs is lower, but the machine gives smoother motions (outputs).

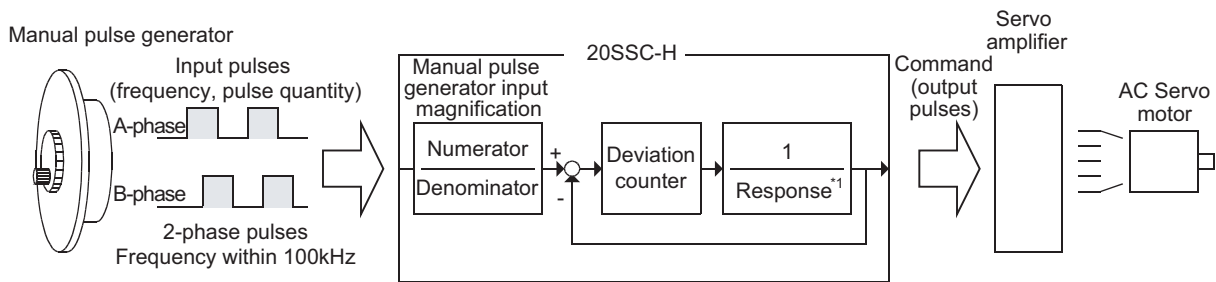

*1. Set it in "MPG response" in the control data.

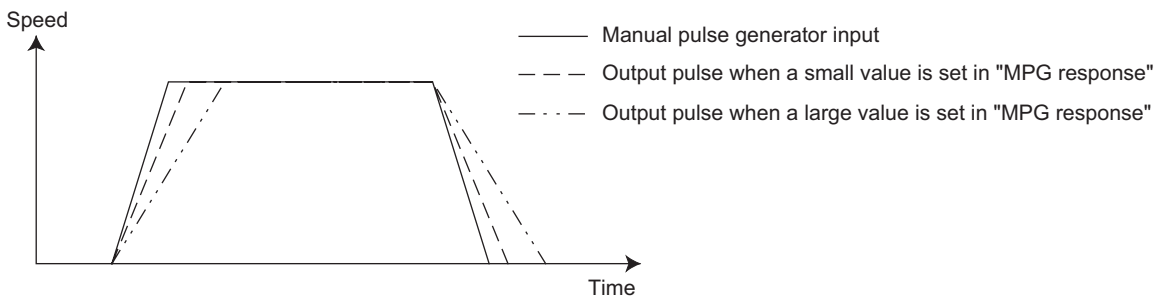

Caution

An error may occur when the response is drastically changed from low to high or from high to low while the manual pulse generator is operating.

- One manual pulse generator can control both the X- and Y-axes by setting the manual pulse generator input selection (Ver. 1.10 or later).

The table below shows the set value in MPG input selection.

	BFM Number		Description
	X-axis	Y-axis	
MPG input selection	BFM #529	-	Sets the MPG input selection (Ver.1.10 or later) 0: Operates the X-axis by X-axis input, and operates the Y-axis by Y-axis input. 1: Operates the X-axis by X-axis input. 2: Operates both the X- and Y-axes by X-axis input.

When one manual pulse generator is shared by the X-axis and Y-axis

- When operating the X-axis using the X-axis input, set K0 to MPG input selection. In this case, set any choice other than "manual pulse generator operation" to "operation pattern selection" for the Y-axis.

		BFM Number		Description
		X-axis	Y-axis	
Manual pulse generator operation	Operation pattern selection	BFM #520 b6	BFM #620 b6	Set each axis as follows. X-axis: ON Y-axis: OFF
MPG input selection		BFM #529	-	Sets to K0.

- When operating the Y-axis using the X-axis input, set K1 to MPG input selection.

		BFM Number		Description
		X-axis	Y-axis	
Manual pulse generator operation	Operation pattern selection	BFM #520 b6	BFM #620 b6	Set each axis as follows. X-axis: OFF Y-axis: ON
MPG input selection		BFM #529	-	Sets to K1.

- When operating both the X-axis and the Y-axis at the same time using the X-axis input, set K2 to MPG input selection.

		BFM Number		Description
		X-axis	Y-axis	
Manual pulse generator operation	Operation pattern selection	BFM #520 b6	BFM #620 b6	Set each axis as follows. X-axis: ON Y-axis: ON
MPG input selection		BFM #529	-	Sets to K2.

Caution

Change the setting of manual pulse generator operation when the manual pulse generator is not operating (that is, while the servo motor is stopped).

8.3.2 Current manual pulse input value

The current number of total input pulses from the manual pulse generator is stored. The current value is added in normal rotation, and subtracted in reverse rotation. The stored data does not include the manual pulse generator input magnification.

	BFM Number		Data type
	X-axis	Y-axis	
Manual pulse generator input current value	BFM #13, #12	BFM #113, #112	Monitor data

8.3.3 Input frequency of manual pulse generator

The frequency of the manual pulse generator inputs is stored. The sign of an increasing count is positive (+), while the sign of a decreasing count is negative (-). The stored data does not include the manual pulse generator input magnification.

	BFM Number		Data type
	X-axis	Y-axis	
Manual pulse generator input frequency	BFM #15, #14	BFM #115, #114	Monitor data

9. Positioning Control

This chapter describes the control of each positioning operation.
For table operation control, refer to the following chapter.

→ For details on the table operation, refer to Chapter 10

9.1 Functions Available with Each Positioning Operation

	1-speed positioning	Interrupt 1-speed constant quantity feed	2-speed positioning	Interrupt 2-speed constant quantity feed	Interrupt stop	Variable speed operation	Multi-speed operation	Linear interpolation	Linear interpolation (Interrupt stop)	Circular interpolation	Reciprocal movement instruction ^{*4}	Reference
Approximate S-shaped acceleration/deceleration, trapezoidal acceleration/deceleration	○	○	○	○	○	○	○	○ ^{*1}	○ ^{*1}	○ ^{*1}	○	Section 7.2
Forward rotation limit, reverse rotation limit	○	○	○	○	○	○	○	○	○	○	○	Section 7.3
STOP command	○	○	○	○	○	○	○	○	○	○	○	Section 7.4
STOP command (Sudden stop selection) ^{*5}	○	○	○	○	○	○	○	○	○	○	○	Section 7.5
Operation speed change	Override function	○	○	○	○	○	○	○	○	○	○	Subsection 7.6.1
	Operation speed change function	△	△	△	△	△	-	△	△	△	△	Subsection 7.6.2
Target address change	△	△	△	△	△	-	-	-	-	-	△	Subsection 7.6.3
Ring counter setting	○	○	○	○	○	○	○	-	-	-	○	Section 7.8
Servo ready check	○	○	○	○	○	○	○	○	○	○	○	Subsection 7.9.1
Servo end check	○	○	○	○	○	○	○ ^{*2}	○ ^{*3}	○ ^{*3}	○ ^{*3}	○	Subsection 7.9.2
Torque limit	○	○	○	○	○	○	○	○	○	○	○	Subsection 7.9.3
Simultaneous start function	○	○	○	○	○	-	-	-	-	-	○	Subsection 7.9.8

○ : Applicable

△ : When the speed change disable during operation signal is ON, the operation speed and target address cannot be changed.

- : Not applicable

- *1. Operation becomes trapezoidal acceleration/deceleration.
Even if the approximate S-shaped acceleration/deceleration is set by the positioning parameters, the operation will execute with trapezoidal acceleration/deceleration.
- *2. The servo end check is not performed during continuous operation.
- *3. The servo end check is not performed during continuous pass operation.
- *4. Supported in Ver.1.10 or later.
- *5. Supported in Ver.1.20 or later.

9.2 1-speed Positioning Operation

- For details on the operation speed change and target address change, refer to Section 7.6
- For details on the torque limit, refer to Subsection 7.9.3
- For details on the STOP command, refer to Section 7.4
- For setting of ring operation in the current address, refer to Section 7.8
- For details on the table operation, refer to Chapter 10

1. Operation

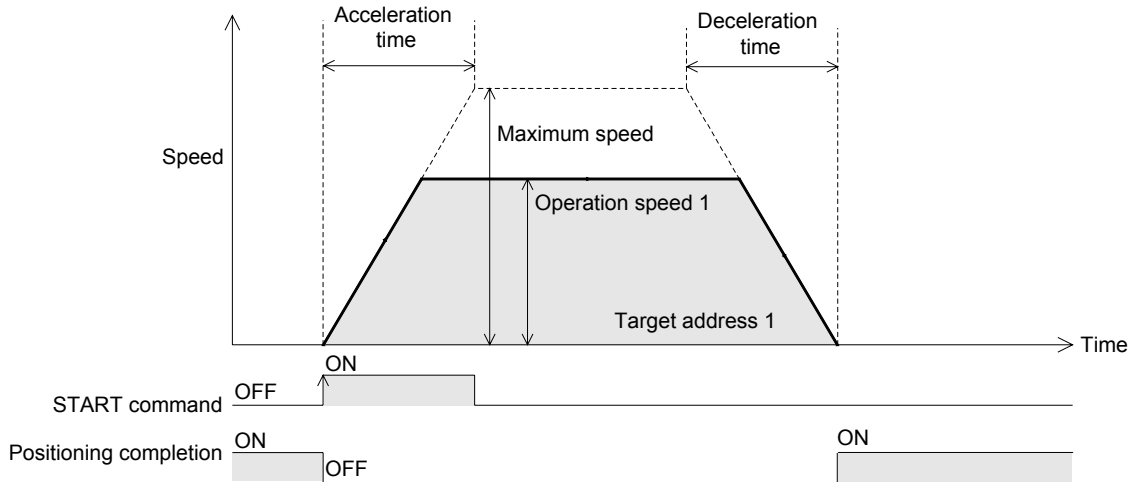

- 1) Set the operation speed 1 and target address 1.
- 2) Select the 1-speed positioning operation from the operation patterns and activate the START command to start the 1-speed positioning operation (above figure).
(The positioning completion signal is turned OFF.)
- 3) The operation stops at the target address 1, and the operation ends, turning the positioning completion signal ON.

→ For the parameters, control data and monitor data, refer to Chapter 11

		BFM Number		Data type
		X-axis	Y-axis	
Target address 1		BFM #501,#500	BFM #601,#600	Control data
Operation speed 1		BFM #503,#502	BFM #603,#602	Control data
1-speed positioning operation	Operation pattern selection	BFM #520 b0	BFM #620 b0	Control data
STOP command	Operation command 1	BFM #518 b1	BFM #618 b1	Control data
Relative/absolute address specification	Operation command 1	BFM #518 b8	BFM #618 b8	Control data
START command	Operation command 1	BFM #518 b9	BFM #618 b9	Control data
Simultaneous START flag	Operation command 1	BFM #518 b10		Control data
Change command in operation disabled	Operation command 1	BFM #518 b12	BFM #618 b12	Control data
Speed change command in positioning operation	Operation command 1	BFM #518 b13	BFM #618 b13	Control data
Target position change command in positioning operation	Operation command 1	BFM #518 b14	BFM #618 b14	Control data
Remaining distance operation cancel command	Operation command 2	BFM #519 b0	BFM #619 b0	Control data
Acceleration/deceleration time change command (Ver.1.30 or later)	Operation command 2	BFM #519 b5	BFM #619 b5	Control data
Ring operation rotation direction for absolute address (Ver.1.10 or later)		BFM #530	BFM #630	Control data
X-START (input terminal)		-	-	Input terminal
Y-START (input terminal)		-	-	Input terminal
Positioning completion	Status information	BFM #28 b6	BFM #128 b6	Monitor data
READY/BUSY	Status information	BFM #28 b0	BFM #128 b0	Monitor data
Standby for remaining travel distance at stop	Status information	BFM #28 b7	BFM #128 b7	Monitor data

	BFM Number		Data type	
	X-axis	Y-axis		
Received target address (Ver.1.20 or later)	BFM #25,#24	BFM #125,#124	Monitor data	
Received target speed (Ver.1.20 or later)	BFM #27,#26	BFM #127,#126	Monitor data	
Current address (user)	BFM #1,#0	BFM #101,#100	Monitor data	
Current address (pulse)	BFM #3,#2	BFM #103,#102	Monitor data	
Real current address (User) (Ver.1.20 or later)	BFM #21,#20	BFM #121,#120	Monitor data	
Real current address (pulse) (Ver.1.20 or later)	BFM #23,#22	BFM #123,#122	Monitor data	
Operation speed present value	BFM #11,#10	BFM #111,#110	Monitor data	
System of units (user unit)	Operation parameter 1	BFM #14000 b1,b0	BFM #14200 b1,b0	Positioning parameters
Unit of measurement for the user units	Operation parameter 1	BFM #14000 b3,b2	BFM #14200 b3,b2	Positioning parameters
Position data magnification	Operation parameter 1	BFM #14000 b5,b4	BFM #14200 b5,b4	Positioning parameters
Acceleration/deceleration mode	Operation parameter 1	BFM #14000 b11	BFM #14200 b11	Positioning parameters
STOP mode	Operation parameter 1	BFM #14000 b15	BFM #14200 b15	Positioning parameters
Servo end check enabled/disabled	Operation parameter 2	BFM #14002 b0	BFM #14202 b0	Positioning parameters
Servo ready check enabled/disabled	Operation parameter 2	BFM #14002 b1	BFM #14202 b1	Positioning parameters
Ring counter setting (Ver.1.30 or later)	Operation parameter 2	BFM #14002 b3	BFM #14202 b3	Positioning parameters
Pulse rate		BFM #14005,#14004	BFM #14205,#14204	Positioning parameters
Feed rate		BFM #14007,#14006	BFM #14207,#14206	Positioning parameters
Maximum speed		BFM #14009,#14008	BFM #14209,#14208	Positioning parameters
Acceleration time		BFM #14018	BFM #14218	Positioning parameters
Deceleration time		BFM #14020	BFM #14220	Positioning parameters
Servo end evaluation time		BFM #14032	BFM #14232	Positioning parameters
Ring counter upper limit value (Ver. 1.10 or later)		BFM #14101,#14100	BFM #14301,#14300	Positioning parameters
Positioning completion signal output waiting time (Ver.1.20 or later)		BFM #14106	BFM #14306	Positioning parameters
Acceleration time 2 (Ver.1.30 or later)		BFM #14108	BFM #14308	Positioning parameters
Deceleration time 2 (Ver.1.30 or later)		BFM #14110	BFM #14310	Positioning parameters

POINT

The positioning completion signal turns ON if the travel distance is 0.

If the travel distance is 0 or the travel time is too short, however, it is impossible for the sequence program to detect the positioning completion signal turning OFF.*1

- *1. Turning OFF of the positioning completion signal can be detected when the positioning completion signal output waiting time is set if the version is Ver.1.20 or later.

→ **For details on the Positioning completion signal output waiting time, refer to Subsection 7.9.11**

2. Operation Speed

The actual operation speed is "operation speed 1 × override setting."

Operation speed 1 can be changed using the operation speed change function except under the following conditions.

→ **For change of the operation speed, refer to Section 7.6**

- During deceleration operation
- When the speed change disable during operation signal is ON.

3. Address Specification

The absolute/relative address can be specified.

With the specified absolute address: Specifies a target address (position) using address 0 as the base.

With the specified relative address: Specifies a travel distance from the current address.

4. Rotation Direction

With the specified absolute address: The rotation direction depends on whether the target address 1 is larger or smaller than the current address.

With the specified relative address: The rotation direction is decided by the sign (positive/negative) of target address 1.

9.3 Interrupt 1-speed Constant Quantity Feed

The interrupt 1-speed constant quantity feed function is also supported in Ver. 1.10 or later when the ring operation is set for the current address.

(Refer to Subsection 9.3.2.)

→ For details on the operation speed change and target address change, refer to Section 7.6

→ For details on the torque limit, refer to Subsection 7.9.3

→ For details on the STOP command, refer to Section 7.4

→ For details on the ring counter setting, refer to Section 7.8

→ For details on the table operation, refer to Chapter 10

9.3.1 Interrupt 1-speed Constant Quantity Feed

When the interrupt 1-speed constant quantity feed mode selection (BFM #519/#619 b6) is OFF, the 20SSC-H positions the motor by the relative movement quantity set in the target address 1 after an interrupt input is given.

(This function is same as the function available in versions earlier than Ver.1.10.)

1. Operation

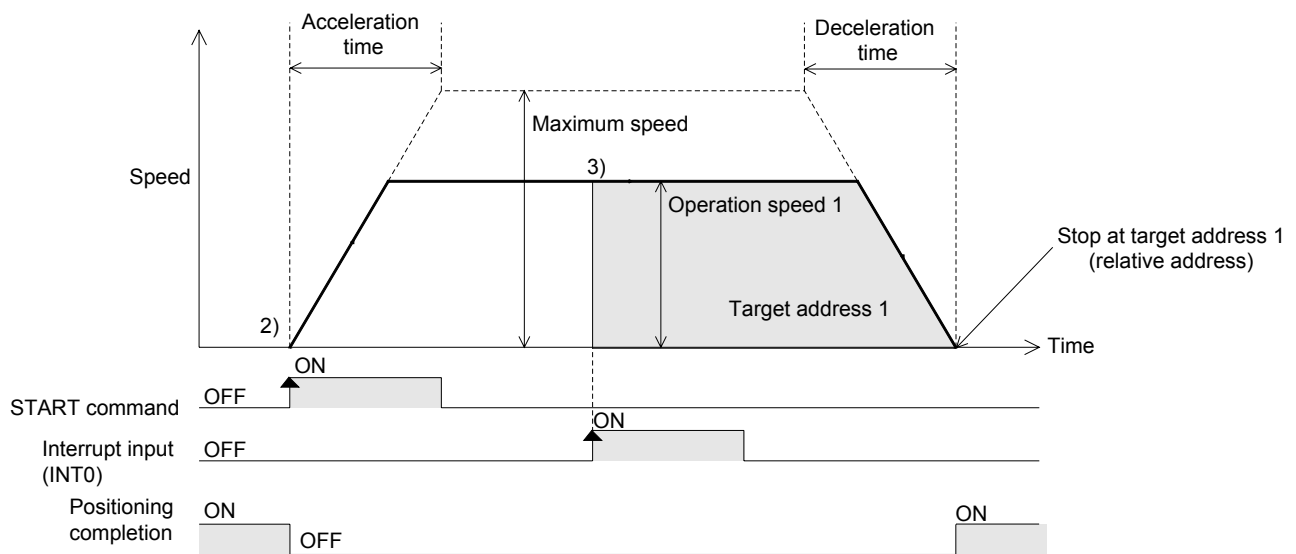

- 1) Set the operation speed 1 and target address 1 (travel distance after interrupt input).
- 2) Select the interrupt 1-speed constant quantity feed from the operation patterns and activate the START command to start the interrupt 1-speed constant quantity feed (above figure).
(The positioning completion signal is turned OFF.)
- 3) At interrupt input (INT0) ON, the work piece moves at the operation speed 1 to the target address 1, where the operation ends and the positioning completion signal turns ON.

In a 20SSC-H Ver. 1.30 or later, the current address when an interrupt input (INT0) occurs is stored in the "current address when an interrupt occurs (INT0)."

→ For the parameters, control data and monitor data, refer to Chapter 11

		BFM Number		Data type
		X-axis	Y-axis	
Target address 1		BFM #501,#500	BFM #601,#600	Control data
Operation speed 1		BFM #503,#502	BFM #603,#602	Control data
Interrupt 1-speed constant quantity feed	Operation pattern selection	BFM #520 b1	BFM #620 b1	Control data
STOP command	Operation command 1	BFM #518 b1	BFM #618 b1	Control data
START command	Operation command 1	BFM #518 b9	BFM #618 b9	Control data
Simultaneous START flag	Operation command 1	BFM #518 b10		Control data
Change command in operation disabled	Operation command 1	BFM #518 b12	BFM #618 b12	Control data
Speed change command in positioning operation	Operation command 1	BFM #518 b13	BFM #618 b13	Control data

		BFM Number		Data type
		X-axis	Y-axis	
Target position change command in positioning operation	Operation command 1	BFM #518 b14	BFM #618 b14	Control data
Remaining distance operation cancel command	Operation command 2	BFM #519 b0	BFM #619 b0	Control data
Acceleration/deceleration time change command (Ver.1.30 or later)	Operation command 2	BFM #519 b5	BFM #619 b5	Control data
Interrupt 1-speed constant quantity feed (Ver.1.10 or later)	Operation command 2	BFM #519 b6	BFM #619 b6	Control data
Ring operation rotation direction for absolute address (Ver.1.10 or later)		BFM #530	BFM #630	Control data
X-START(Input terminal)		-	-	Input terminal
Y-START(Input terminal)		-	-	Input terminal
X-INT0(Input terminal)		-	-	Input terminal
Y-INT0(Input terminal)		-	-	Input terminal
Positioning completion	Status information	BFM #28 b6	BFM #128 b6	Monitor data
READY/BUSY	Status information	BFM #28 b0	BFM #128 b0	Monitor data
Standby for remaining travel distance at stop	Status information	BFM #28 b7	BFM #128 b7	Monitor data
Received target address (Ver.1.20 or later)		BFM #25,#24	BFM #125,#124	Monitor data
Received target speed (Ver.1.20 or later)		BFM #27,#26	BFM #127,#126	Monitor data
Current address (user)		BFM #1,#0	BFM #101,#100	Monitor data
Current address (pulse)		BFM #3,#2	BFM #103,#102	Monitor data
Real current address (User) (Ver.1.20 or later)		BFM #21,#20	BFM #121,#120	Monitor data
Real current address (pulse) (Ver.1.20 or later)		BFM #23,#22	BFM #123,#122	Monitor data
Operation speed present value		BFM #11,#10	BFM #111,#110	Monitor data
Current address when an interrupt occurs (INT0) (Ver.1.30 or later)*1		BFM #35,#34	BFM #135,#134	Monitor data
System of units (user unit)	Operation parameter 1	BFM #14000 b1,b0	BFM #14200 b1,b0	Positioning parameters
Unit of measurement for the user units	Operation parameter 1	BFM #14000 b3,b2	BFM #14200 b3,b2	Positioning parameters
Position data magnification	Operation parameter 1	BFM #14000 b5,b4	BFM #14200 b5,b4	Positioning parameters
Acceleration/deceleration mode	Operation parameter 1	BFM #14000 b11	BFM #14200 b11	Positioning parameters
STOP mode	Operation parameter 1	BFM #14000 b15	BFM #14200 b15	Positioning parameters
Servo end check enabled/disabled	Operation parameter 2	BFM #14002 b0	BFM #14202 b0	Positioning parameters
Servo ready check enabled/disabled	Operation parameter 2	BFM #14002 b1	BFM #14202 b1	Positioning parameters
Ring counter setting (Ver.1.10 or later)	Operation parameter 2	BFM #14002 b3	BFM #14202 b3	Positioning parameters
Pulse rate		BFM #14005,#14004	BFM #14205,#14204	Positioning parameters
Feed rate		BFM #14007,#14006	BFM #14207,#14206	Positioning parameters
Maximum speed		BFM #14009,#14008	BFM #14209,#14208	Positioning parameters
Acceleration time		BFM #14018	BFM #14218	Positioning parameters
Deceleration time		BFM #14020	BFM #14220	Positioning parameters
Servo end evaluation time		BFM #14032	BFM #14232	Positioning parameters
Ring counter upper limit value (Ver. 1.10 or later)		BFM #14101,#14100	BFM #14301,#14300	Positioning parameters
Positioning completion signal output waiting time (Ver.1.20 or later)		BFM #14106	BFM #14306	Positioning parameters
Acceleration time 2 (Ver.1.30 or later)		BFM #14108	BFM #14308	Positioning parameters
Deceleration time 2 (Ver.1.30 or later)		BFM #14110	BFM #14310	Positioning parameters

- *1. The error in the calculation of user units is included in the value of the current address when an interrupt occurs.

Note

The travel distance for target address 1 must be larger than the deceleration distance to stop.
If the travel distance for target address 1 is smaller, the work piece decelerates as much as possible, and the operation stops.

→ For details, refer to Subsection 7.11.2

2. Operation speed

The actual operation speed is "operation speed 1 x override setting."

Operation speed 1 can be changed using the operation speed change function except under the following conditions.

→ For change of the operation speed, refer to Section 7.6

- During deceleration operation
- When the speed change disable during operation signal is ON.

3. Address specification

Specified addresses are handled as relative addresses (travel distance from the current address).
(The absolute/relative address specification is ignored.)

4. Rotation Direction

The sign of the target address decides the operation direction.

- + : Operates in the direction that increases the current value. (When the value is 0, it is regarded as 1.)
- : Operates in the direction that decreases the current value.

9.3.2 Interrupt 1-speed Constant Quantity Feed (Constant position stop mode)

When the ring operation for current address (BFM #14002/#14202 b3)^{*1} is ON and the interrupt 1-speed constant quantity feed mode selection (BFM #519/#619 b6)^{*1} is ON, the 20SSC-H positions the motor by the absolute movement quantity set in the target address 1 after interrupt input is given.

This function is new for Ver.1.10.

*1. Only supported 20SSC-H Ver. 1.10 or later.

1. Operation

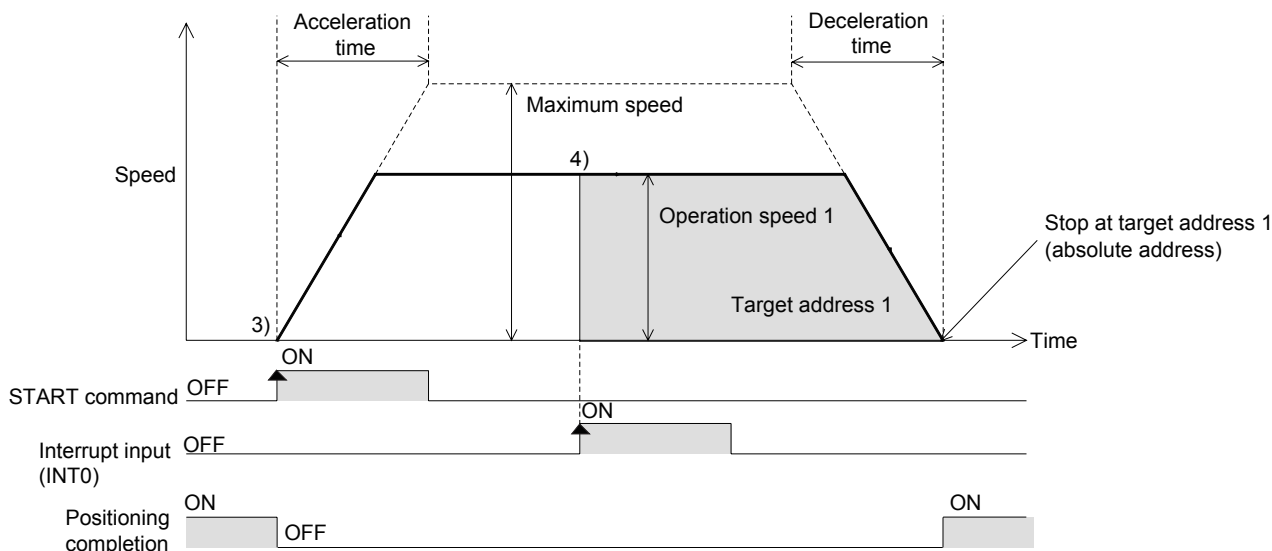

- 1) Turn ON the ring operation for current address and interrupt 1-speed constant quantity feed mode selection.
- 2) Set the operation speed 1 and target address 1 (position after interrupt input).
- 3) Select "interrupt 1-speed constant quantity feed" as the operation pattern, and turn ON the START command. The 20SSC-H starts interrupt 1-speed constant quantity feed at operation speed 1 (and turns OFF the positioning completion signal) (as shown above).
- 4) When the interrupt input (INT0) turns ON, the 20SSC-H positions the motor to target address 1 position at operation speed 1, where the operation ends and the positioning completion signal turns ON. In a 20SSC-H Ver. 1.30 or later, the current address when an interrupt input (INT0) occurs is stored in the BFM "current address when an interrupt occurs (INT0)."

→ For the parameters, control data and monitor data, refer to Chapter 11

		BFM Number		Data type
		X-axis	Y-axis	
Target address 1		BFM #501,#500	BFM #601,#600	Control data
Operation speed 1		BFM #503,#502	BFM #603,#602	Control data
Interrupt 1-speed constant quantity feed	Operation pattern selection	BFM #520 b1	BFM #620 b1	Control data
STOP command	Operation command 1	BFM #518 b1	BFM #618 b1	Control data
START command	Operation command 1	BFM #518 b9	BFM #618 b9	Control data
Simultaneous START flag	Operation command 1	BFM #518 b10		Control data
Change command in operation disabled	Operation command 1	BFM #518 b12	BFM #618 b12	Control data
Speed change command in positioning operation	Operation command 1	BFM #518 b13	BFM #618 b13	Control data
Target position change command in positioning operation	Operation command 1	BFM #518 b14	BFM #618 b14	Control data
Remaining distance operation cancel command	Operation command 2	BFM #519 b0	BFM #619 b0	Control data
Acceleration/deceleration time change command (Ver.1.30 or later)	Operation command 2	BFM #519 b5	BFM #619 b5	Control data

		BFM Number		Data type
		X-axis	Y-axis	
Mode selection for the Interrupt 1-speed constant quantity feed (Ver.1.10 or later)	Operation command 2	BFM #519 b6	BFM #619 b6	Control data
Interrupt 1-speed Constant Quantity Feed (Constant position stop mode) shortest allowable stop (Ver.1.30 or later)	Operation command 2	BFM #519 b7	BFM #619 b7	Control data
Ring operation rotation direction for absolute address (Ver.1.10 or later)		BFM #530	BFM #630	Control data
X-START(Input terminal)		-	-	Input terminal
Y-START(Input terminal)		-	-	Input terminal
X-INT0(Input terminal)		-	-	Input terminal
Y-INT0(Input terminal)		-	-	Input terminal
Positioning completion	Status information	BFM #28 b6	BFM #128 b6	Monitor data
READY/BUSY	Status information	BFM #28 b0	BFM #128 b0	Monitor data
Standby for remaining travel distance at stop	Status information	BFM #28 b7	BFM #128 b7	Monitor data
Received target address (Ver.1.20 or later)		BFM #25,#24	BFM #125,#124	Monitor data
Received target speed (Ver.1.20 or later)		BFM #27,#26	BFM #127,#126	Monitor data
Current address (user)		BFM #1,#0	BFM #101,#100	Monitor data
Current address (pulse)		BFM #3,#2	BFM #103,#102	Monitor data
Real current address (user) (Ver.1.20 or later)		BFM #21,#20	BFM #121,#120	Monitor data
Real current address (pulse) (Ver.1.20 or later)		BFM #23,#22	BFM #123,#122	Monitor data
Operation speed present value		BFM #11,#10	BFM #111,#110	Monitor data
Current address when an interrupt occurs (INT0)*1 (Ver.1.30 or later)		BFM #35,#34	BFM #135,#134	Monitor data
System of units (user unit)	Operation parameter 1	BFM #14000 b1,b0	BFM #14200 b1,b0	Positioning parameters
Unit of measurement for the user units	Operation parameter 1	BFM #14000 b3,b2	BFM #14200 b3,b2	Positioning parameters
Position data magnification	Operation parameter 1	BFM #14000 b5,b4	BFM #14200 b5,b4	Positioning parameters
Acceleration/deceleration mode	Operation parameter 1	BFM #14000 b11	BFM #14200 b11	Positioning parameters
STOP mode	Operation parameter 1	BFM #14000 b15	BFM #14200 b15	Positioning parameters
Servo end check enabled/disabled	Operation parameter 2	BFM #14002 b0	BFM #14202 b0	Positioning parameters
Servo ready check enabled/disabled	Operation parameter 2	BFM #14002 b1	BFM #14202 b1	Positioning parameters
Ring counter setting (Ver.1.10 or later)	Operation parameter 2	BFM #14002 b3	BFM #14202 b3	Positioning parameters
Pulse rate		BFM #14005,#14004	BFM #14205,#14204	Positioning parameters
Feed rate		BFM #14007,#14006	BFM #14207,#14206	Positioning parameters
Maximum speed		BFM #14009,#14008	BFM #14209,#14208	Positioning parameters
Acceleration time		BFM #14018	BFM #14218	Positioning parameters
Deceleration time		BFM #14020	BFM #14220	Positioning parameters
Servo end evaluation time		BFM #14032	BFM #14232	Positioning parameters
Ring counter upper limit value (Ver. 1.10 or later)		BFM #14101,#14100	BFM #14301,#14300	Positioning parameters
Sudden stop deceleration time (Ver.1.20 or later)		BFM #14102	BFM #14302	Positioning parameters
Positioning completion signal output waiting time (Ver.1.20 or later)		BFM #14106	BFM #14306	Positioning parameters
Acceleration time 2 (Ver.1.30 or later)		BFM #14108	BFM #14308	Positioning parameters
Deceleration time 2 (Ver.1.30 or later)		BFM #14110	BFM #14310	Positioning parameters

- *1. The error in the calculation of user units is included in the value of the current address when an interrupt occurs.

Note

- The system operates as follows when the travel distance to the target position (target address 1) after the interrupt input (INT0) turns ON is shorter than the travel distance required for a deceleration stop:
 - **For details, refer to Subsection 7.11.2**
 - a) When the version is earlier than Ver. 1.30
If the system cannot stop at the target position (target address 1) by the setting value of deceleration time, it passes the 1st target position (target address 1), decelerates, and then stops in the 2nd target position (target address 1).
 - b) When the version is Ver. 1.30 or later and "interrupt 1-speed constant quantity feed (constant position stop mode) shortest allowable stop" is disabled, the system performs in the same way as versions earlier than Ver. 1.30.
 - c) When the version is Ver. 1.30 or later and "interrupt 1-speed constant quantity feed (constant position stop mode) shortest allowable stop" is enabled.
If the system cannot stop at the target position (target address 1) with the setting value of deceleration time, it stops at the target position (target address 1) using a deceleration time^{*1} set by the 20SSC-H automatically.
However, if the travel distance to the target position (target address 1) after the interrupt input (INT0) turns ON is shorter than the travel distance required for a sudden stop, the system passes the 1st target position (target address 1), decelerates, and then stops at the 2nd target position (target address 1).
→ **For sudden stop, refer to Section 7.5**
- *1. Deceleration time setting value is automatically set between sudden stop deceleration time and deceleration time.
- After the interrupt input (INT0) turns ON, if the target address change function is executed to change the target address to an address in the opposite direction from the one already specified, the target address change function is ignored.

2. Operation speed

The actual operation speed is "operation speed 1 x override setting."

Operation speed 1 can be changed using the operation speed change function except under the following conditions.

→ **For change of the operation speed, refer to Section 7.6**

- During deceleration operation
- When the speed change disable during operation signal is ON.

3. Address specification

Specified address are handled as absolute addresses.
(The absolute/relative address specification is ignored.)

4. Rotation Direction

The sign of target address 1 decides the operation direction.

- + : Operates in the direction that increases the current value.
- : Operates in the direction that decreases the current value.

9.4 2-speed Positioning Operation

- For details on the operation speed change and target address change, refer to Section 7.6
- For details on the torque limit, refer to Subsection 7.9.3
- For details on the STOP command, refer to Section 7.4
- For setting of ring operation in the current address, refer to Section 7.8
- For details on the table operation, refer to Chapter 10

1. Operation

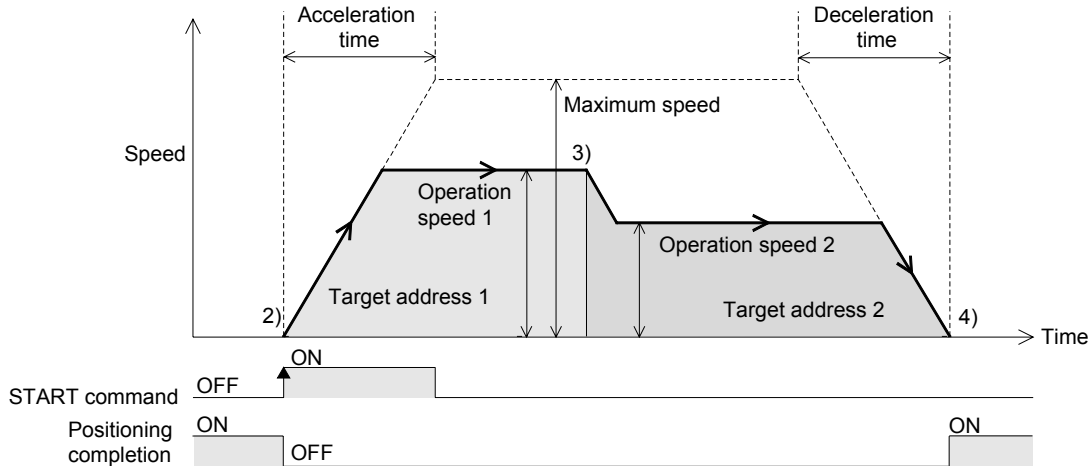

- 1) Set the operation speed 1, operation speed 2, target address 1, and target address 2.
- 2) Select the 2-speed positioning operation from the operation patterns and activate the START command to start the 2-speed positioning operation (above figure).
(The positioning completion signal is turned OFF.)
- 3) Acceleration or deceleration operation to shift to operation speed 2 is started upon reaching the target address 1.
- 4) The work piece stops at target address 2 and the operation ends, turning the positioning completion signal ON.

→ For the parameters, control data and monitor data, refer to Chapter 11

		BFM Number		Data type
		X-axis	Y-axis	
Target address 1		BFM #501,#500	BFM #601,#600	Control data
Operation speed 1		BFM #503,#502	BFM #603,#602	Control data
Target address 2		BFM #505,#504	BFM #605,#604	Control data
Operation speed 2		BFM #507,#506	BFM #607,#606	Control data
2-speed positioning operation	Operation pattern selection	BFM #520 b2	BFM #620 b2	Control data
STOP command	Operation command 1	BFM #518 b1	BFM #618 b1	Control data
Relative/absolute address specification	Operation command 1	BFM #518 b8	BFM #618 b8	Control data
START command	Operation command 1	BFM #518 b9	BFM #618 b9	Control data
Simultaneous START flag	Operation command 1	BFM #518 b10		Control data
Change command in operation disabled	Operation command 1	BFM #518 b12	BFM #618 b12	Control data
Speed change command in positioning operation	Operation command 1	BFM #518 b13	BFM #618 b13	Control data
Target position change command in positioning operation	Operation command 1	BFM #518 b14	BFM #618 b14	Control data
Remaining distance operation cancel command	Operation command 2	BFM #519 b0	BFM #619 b0	Control data
Acceleration/deceleration time change command (Ver. 1.30 or later)	Operation command 2	BFM #519 b5	BFM #619 b5	Control data

		BFM Number		Data type
		X-axis	Y-axis	
Ring operation rotation direction for absolute address (Ver. 1.10 or later)		BFM #530	BFM #630	Control data
X-START(Input terminal)		-	-	Input terminal
Y-START(Input terminal)		-	-	Input terminal
Positioning completion	Status information	BFM #28 b6	BFM #128 b6	Monitor data
READY/BUSY	Status information	BFM #28 b0	BFM #128 b0	Monitor data
Standby for remaining travel distance at stop	Status information	BFM #28 b7	BFM #128 b7	Monitor data
Received target address (Ver. 1.20 or later)		BFM #25,#24	BFM #125,#124	Monitor data
Received target speed (Ver. 1.20 or later)		BFM #27,#26	BFM #127,#126	Monitor data
Current address (user)		BFM #1,#0	BFM #101,#100	Monitor data
Current address (pulse)		BFM #3,#2	BFM #103,#102	Monitor data
Real current address (user) (Ver. 1.20 or later)		BFM #21,#20	BFM #121,#120	Monitor data
Real current address (pulse) (Ver. 1.20 or later)		BFM #23,#22	BFM #123,#122	Monitor data
Operation speed present value		BFM #11,#10	BFM #111,#110	Monitor data
System of units (user unit)	Operation parameter 1	BFM #14000 b1,b0	BFM #14200 b1,b0	Positioning parameters
Unit of measurement for the user units	Operation parameter 1	BFM #14000 b3,b2	BFM #14200 b3,b2	Positioning parameters
Position data magnification	Operation parameter 1	BFM #14000 b5,b4	BFM #14200 b5,b4	Positioning parameters
Acceleration/deceleration mode	Operation parameter 1	BFM #14000 b11	BFM #14200 b11	Positioning parameters
STOP mode	Operation parameter 1	BFM #14000 b15	BFM #14200 b15	Positioning parameters
Servo end check enabled/disabled	Operation parameter 2	BFM #14002 b0	BFM #14202 b0	Positioning parameters
Servo ready check enabled/disabled	Operation parameter 2	BFM #14002 b1	BFM #14202 b1	Positioning parameters
Ring counter setting (Ver. 1.10 or later)	Operation parameter 2	BFM #14002 b3	BFM #14202 b3	Positioning parameters
Pulse rate		BFM #14005,#14004	BFM #14205,#14204	Positioning parameters
Feed rate		BFM #14007,#14006	BFM #14207,#14206	Positioning parameters
Maximum speed		BFM #14009,#14008	BFM #14209,#14208	Positioning parameters
Acceleration time		BFM #14018	BFM #14218	Positioning parameters
Deceleration time		BFM #14020	BFM #14220	Positioning parameters
Servo end evaluation time		BFM #14032	BFM #14232	Positioning parameters
Ring counter upper limit value (Ver. 1.10 or later)		BFM #14101,#14100	BFM #14301,#14300	Positioning parameters
Positioning completion signal output waiting time (Ver. 1.20 or later)		BFM #14106	BFM #14306	Positioning parameters
Acceleration time 2 (Ver. 1.30 or later)		BFM #14108	BFM #14308	Positioning parameters
Deceleration time 2 (Ver. 1.30 or later)		BFM #14110	BFM #14310	Positioning parameters

2. Operation speed

The actual operation speed is decided by the following calculation formulas.

- Operation speed 1 × Override setting
- Operation speed 2 × Override setting

The actual operation speed 1 and operation speed 2 can be changed using the operation speed change function except under the following conditions.

→ For change of the operation speed, refer to Section 7.6

- During deceleration operation from operation speed 2
- When the speed change disable during operation signal is ON.

3. Address Specification

The absolute/relative address can be specified.

With the specified absolute address: Specifies a target address (position) using address 0 as the base.

With the specified relative address: Specifies a travel distance from the current address.

4. Rotation Direction

With the specified absolute address: The rotation direction depends on whether the target address 1 and 2 are larger or smaller than the current address.

With the specified relative address: The rotation direction is decided by the sign (positive/negative) of target address 1 and 2.

Note

If the moving directions of target address 1 and target address 2 are not the same as follows, a reverse operation is performed immediately after the deceleration stop at target address 1.

With the specified absolute address: when the sign difference between the current value and target address 1 is different from the sign difference between target address 1 and target address 2.

With the specified relative address : when the sign (positive/negative) of target address 1 differs from that of target address 2.

Caution

An abrupt change in the rotation direction may cause damage to the machine. It may also cause an error through motor overload.

If the operation in a different direction requires stop time, use the 1-speed positioning operation.

5. Speed switching

Speed switching is classified into "standard switching" and "front-load switching".

In the FX3U-20SSC-H, the speed is switched by standard switching. (Refer to the figure below.)

<Operation by standard switching>

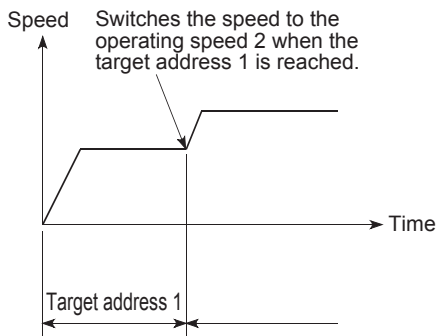

<Operation by front-load switching>

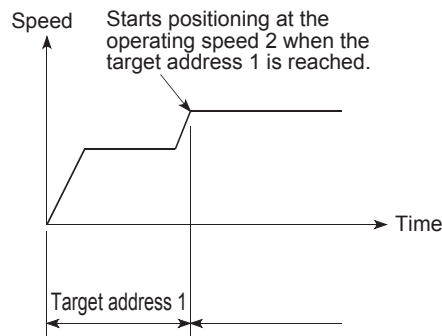

9.5 Interrupt 2-speed Constant Quantity Feed

→ For details on the operation speed change and target address change, refer to Section 7.6

→ For details on the torque limit, refer to Subsection 7.9.3

→ For details on the STOP command, refer to Section 7.4

→ For setting of ring operation in the current address, refer to Section 7.8

→ For details on the table operation, refer to Chapter 10

1. Operation

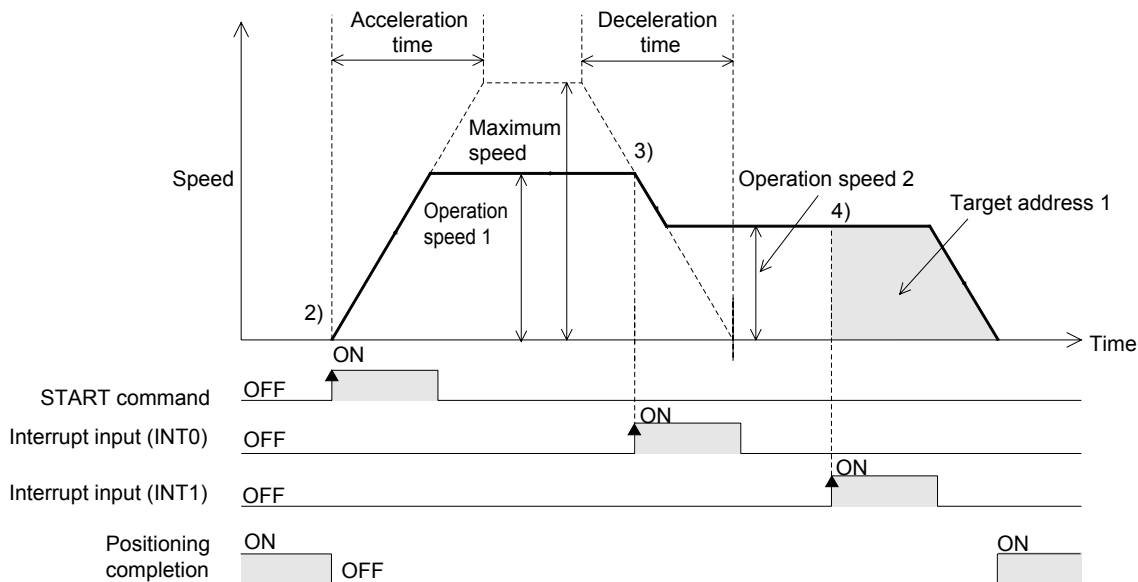

- 1) Set the operation speed 1, operation speed 2, and target address 1.
- 2) Select Interrupt 2-speed constant quantity feed from the operation patterns and activate the START command to start the Interrupt 2-speed constant quantity feed (above figure). (The positioning completion signal is turned OFF.)
- 3) At interrupt input (INT0) ON, the work piece starts accelerating/decelerating to operation speed 2. In the 20SSC-H Ver. 1.30 or later, the current address when an interrupt input (INT0) occurs is stored in the "current address when an interrupt occurs (INT0)."
- 4) At interrupt input (INT1) ON, the work piece moves at operation speed 2 to target address 1, and the operation ends, turning ON the positioning completion signal. In a 20SSC-H Ver. 1.30 or later, the current address when an interrupt input (INT1) occurs is stored in the "current address when an interrupt occurs (INT1)."

→ For the parameters, control data and monitor data, refer to Chapter 11

		BFM Number		Data type
		X-axis	Y-axis	
Target address 1		BFM #501,#500	BFM #601,#600	Control data
Operation speed 1		BFM #503,#502	BFM #603,#602	Control data
Operation speed 2		BFM #507,#506	BFM #607,#606	Control data
Interrupt 2-speed constant quantity feed	Operation pattern selection	BFM #520 b3	BFM #620 b3	Control data
STOP command	Operation command 1	BFM #518 b1	BFM #618 b1	Control data
START command	Operation command 1	BFM #518 b9	BFM #618 b9	Control data
Simultaneous START flag	Operation command 1	BFM #518 b10		Control data
Change command in operation disabled	Operation command 1	BFM #518 b12	BFM #618 b12	Control data
Speed change command in positioning operation	Operation command 1	BFM #518 b13	BFM #618 b13	Control data
Target position change command in positioning operation	Operation command 1	BFM #518 b14	BFM #618 b14	Control data
Remaining distance operation cancel command	Operation command 2	BFM #519 b0	BFM #619 b0	Control data

		BFM Number		Data type
		X-axis	Y-axis	
Acceleration/deceleration time change command (Ver. 1.30 or later)	Operation command 2	BFM #519 b5	BFM #619 b5	Control data
Ring operation rotation direction for absolute address (Ver. 1.10 or later)		BFM #530	BFM #630	Control data
X-START(Input terminal)		-	-	Input terminal
Y-START(Input terminal)		-	-	Input terminal
X-INT0(Input terminal)		-	-	Input terminal
Y-INT0(Input terminal)		-	-	Input terminal
X-INT1(Input terminal)		-	-	Input terminal
Y-INT1(Input terminal)		-	-	Input terminal
Positioning completion	Status information	BFM #28 b6	BFM #128 b6	Monitor data
READY/BUSY	Status information	BFM #28 b0	BFM #128 b0	Monitor data
Standby for remaining travel distance at stop	Status information	BFM #28 b7	BFM #128 b7	Monitor data
Received target address (Ver. 1.20 or later)		BFM #25,#24	BFM #125,#124	Monitor data
Received target speed (Ver. 1.20 or later)		BFM #27,#26	BFM #127,#126	Monitor data
Current address (user)		BFM #1,#0	BFM #101,#100	Monitor data
Current address (pulse)		BFM #3,#2	BFM #103,#102	Monitor data
Real current address (user) (Ver. 1.20 or later)		BFM #21,#20	BFM #121,#120	Monitor data
Real current address (pulse) (Ver. 1.20 or later)		BFM #23,#22	BFM #123,#122	Monitor data
Operation speed present value		BFM #11,#10	BFM #111,#110	Monitor data
Current address when an interrupt occurs (INT0) (Ver. 1.30 or later)*1		BFM #35,#34	BFM #135,#134	Monitor data
Current address when an interrupt occurs (INT1) (Ver. 1.30 or later)*1		BFM #37,#36	BFM #137,#136	Monitor data
System of units (user unit)	Operation parameter 1	BFM #14000 b1,b0	BFM #14200 b1,b0	Positioning parameters
Unit of measurement for the user units	Operation parameter 1	BFM #14000 b3,b2	BFM #14200 b3,b2	Positioning parameters
Position data magnification	Operation parameter 1	BFM #14000 b5,b4	BFM #14200 b5,b4	Positioning parameters
Acceleration/deceleration mode	Operation parameter 1	BFM #14000 b11	BFM #14200 b11	Positioning parameters
STOP mode	Operation parameter 1	BFM #14000 b15	BFM #14200 b15	Positioning parameters
Servo end check enabled/disabled	Operation parameter 2	BFM #14002 b0	BFM #14202 b0	Positioning parameters
Servo ready check enabled/disabled	Operation parameter 2	BFM #14002 b1	BFM #14202 b1	Positioning parameters
Ring counter setting (Ver. 1.10 or later)	Operation parameter 2	BFM #14002 b3	BFM #14202 b3	Positioning parameters
Pulse rate		BFM #14005,#14004	BFM #14205,#14204	Positioning parameters
Feed rate		BFM #14007,#14006	BFM #14207,#14206	Positioning parameters
Maximum speed		BFM #14009,#14008	BFM #14209,#14208	Positioning parameters
Acceleration time		BFM #14018	BFM #14218	Positioning parameters
Deceleration time		BFM #14020	BFM #14220	Positioning parameters
Servo end evaluation time		BFM #14032	BFM #14232	Positioning parameters
Ring counter upper limit value (Ver. 1.10 or later)		BFM #14101,#14100	BFM #14301,#14300	Positioning parameters
Positioning completion signal output waiting time (Ver. 1.20 or later)		BFM #14106	BFM #14306	Positioning parameters
Acceleration time 2 (Ver. 1.30 or later)		BFM #14108	BFM #14308	Positioning parameters
Deceleration time 2 (Ver. 1.30 or later)		BFM #14110	BFM #14310	Positioning parameters

- *1. The error in the calculation of user units is included in the value of the current address when an interrupt occurs.

Note

- Interrupt input is detected in the order of INT0 and INT1.
- The travel distance for target address 1 must be larger than the deceleration distance to stop. If the travel distance for target address 1 is smaller, the work piece decelerates as much as possible, and the operation stops.

→ For details, refer to Subsection 7.11.2

2. Operation speed

The actual operation speed is decided by the following calculation formulas.

- Operation speed 1 × Override setting
- Operation speed 2 × Override setting

The actual operation speed 1 and operation speed 2 can be changed using the operation speed change function except under the following conditions.

→ For change of the operation speed, refer to Section 7.6

- During deceleration operation from operation speed 2
- When the speed change disable during operation signal is ON.

3. Address specification

Specified addresses are handled as relative addresses (travel distance from the current address). (The absolute/relative address specification is ignored.)

4. Rotation Direction

The sign of the target address decides the operation direction.

- + : Operates in the direction that increases the current value. (When the value is 0, it is regarded as 1.)
- : Operates in the direction that decreases the current value.

9.6 Interrupt Stop Operation

- For details on the operation speed change and target address change, refer to Section 7.6
- For details on the torque limit, refer to Subsection 7.9.3
- For details on the STOP command, refer to Section 7.4
- For setting of ring operation in the current address, refer to Section 7.8
- For details on the table operation, refer to Chapter 10

1. Operation

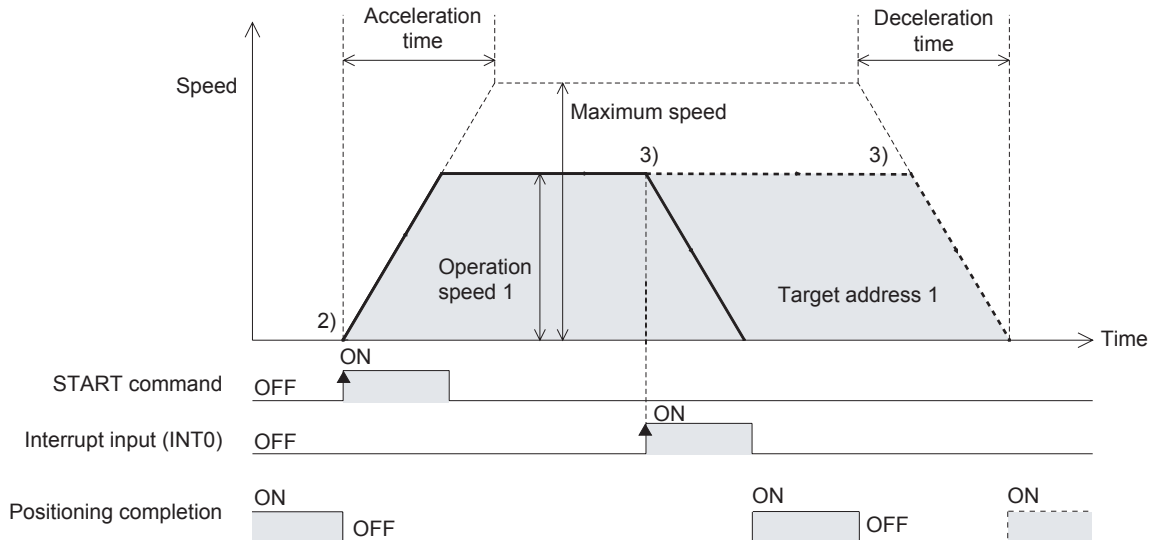

- 1) Set operation speed 1 and target address 1 (maximum travel distance).
- 2) Select the Interrupt stop operation from operation patterns and activate the START command to start the Interrupt stop operation at operation speed 1 (above figure).
(The positioning completion signal is turned OFF.)
- 3) At interrupt input (INT0) ON, before target address 1, the work piece decelerates to stop, and the operation ends, turning the positioning completion signal ON.

When the interrupt input (INT0) does not turn ON before target address 1, the work piece decelerates to stop at target address 1, and the operation ends, turning the positioning completion signal ON.

In a 20SSC-H Ver. 1.30 or later, the current address when an interrupt input (INT0) occurs is stored in the "current address when an interrupt occurs (INT0)."

→ For the parameters, control data and monitor data, refer to Chapter 11

		BFM Number		Data type
		X-axis	Y-axis	
Target address 1		BFM #501,#500	BFM #601,#600	Control data
Operation speed 1		BFM #503,#502	BFM #603,#602	Control data
Interrupt stop	Operation pattern selection	BFM #520 b4	BFM #620 b4	Control data
STOP command	Operation command 1	BFM #518 b1	BFM #618 b1	Control data
Relative/absolute address specification	Operation command 1	BFM #518 b8	BFM #618 b8	Control data
START command	Operation command 1	BFM #518 b9	BFM #618 b9	Control data
Simultaneous START flag	Operation command 1	BFM #518 b10		Control data
Change command in operation disabled	Operation command 1	BFM #518 b12	BFM #618 b12	Control data
Speed change command in positioning operation	Operation command 1	BFM #518 b13	BFM #618 b13	Control data
Target position change command in positioning operation	Operation command 1	BFM #518 b14	BFM #618 b14	Control data
Remaining distance operation cancel command	Operation command 2	BFM #519 b0	BFM #619 b0	Control data
Acceleration/deceleration time change command (Ver. 1.30 or later)	Operation command 2	BFM #519 b5	BFM #619 b5	Control data
Ring operation rotation direction for absolute address (Ver. 1.10 or later)		BFM #530	BFM #630	Control data

		BFM Number		Data type
		X-axis	Y-axis	
X-START(Input terminal)		-	-	Input terminal
Y-START(Input terminal)		-	-	Input terminal
X-INT0(Input terminal)		-	-	Input terminal
Y-INT0(Input terminal)		-	-	Input terminal
Positioning completion	Status information	BFM #28 b6	BFM #128 b6	Monitor data
READY/BUSY	Status information	BFM #28 b0	BFM #128 b0	Monitor data
Standby for remaining travel distance at stop	Status information	BFM #28 b7	BFM #128 b7	Monitor data
Received target address (Ver. 1.20 or later)		BFM #25,#24	BFM #125,#124	Monitor data
Received target speed (Ver. 1.20 or later)		BFM #27,#26	BFM #127,#126	Monitor data
Current address (user)		BFM #1,#0	BFM #101,#100	Monitor data
Current address (pulse)		BFM #3,#2	BFM #103,#102	Monitor data
Real current address (user) (Ver. 1.20 or later)		BFM #21,#20	BFM #121,#120	Monitor data
Real current address (pulse) (Ver. 1.20 or later)		BFM #23,#22	BFM #123,#122	Monitor data
Operation speed present value		BFM #11,#10	BFM #111,#110	Monitor data
Current address when an interrupt occurs (INT0) (Ver. 1.30 or later) ^{*1}		BFM #35,#34	BFM #135,#134	Monitor data
System of units (user unit)	Operation parameter 1	BFM #14000 b1,b0	BFM #14200 b1,b0	Positioning parameters
Unit of measurement for the user units	Operation parameter 1	BFM #14000 b3,b2	BFM #14200 b3,b2	Positioning parameters
Position data magnification	Operation parameter 1	BFM #14000 b5,b4	BFM #14200 b5,b4	Positioning parameters
Acceleration/deceleration mode	Operation parameter 1	BFM #14000 b11	BFM #14200 b11	Positioning parameters
STOP mode	Operation parameter 1	BFM #14000 b15	BFM #14200 b15	Positioning parameters
Servo end check enabled/disabled	Operation parameter 2	BFM #14002 b0	BFM #14202 b0	Positioning parameters
Servo ready check enabled/disabled	Operation parameter 2	BFM #14002 b1	BFM #14202 b1	Positioning parameters
Ring counter setting (Ver. 1.10 or later)	Operation parameter 2	BFM #14002 b3	BFM #14202 b3	Positioning parameters
Pulse rate		BFM #14005,#14004	BFM #14205,#14204	Positioning parameters
Feed rate		BFM #14007,#14006	BFM #14207,#14206	Positioning parameters
Maximum speed		BFM #14009,#14008	BFM #14209,#14208	Positioning parameters
Acceleration time		BFM #14018	BFM #14218	Positioning parameters
Deceleration time		BFM #14020	BFM #14220	Positioning parameters
Servo end evaluation time		BFM #14032	BFM #14232	Positioning parameters
Ring counter upper limit value (Ver. 1.10 or later)		BFM #14101,#14100	BFM #14301,#14300	Positioning parameters
Positioning completion signal output waiting time (Ver. 1.20 or later)		BFM #14106	BFM #14306	Positioning parameters
Acceleration time 2 (Ver. 1.30 or later)		BFM #14108	BFM #14308	Positioning parameters
Deceleration time 2 (Ver. 1.30 or later)		BFM #14110	BFM #14310	Positioning parameters

*1. The error in the calculation of user units is included in the value of the current address when an interrupt occurs.

1	Introduction
2	System configuration
3	Specifications
4	Installation
5	Wiring
6	Memory Config [†] and data operation
7	Before starting positioning operation
8	Manual control
9	Positioning Control
10	Table Operation

2. Operation Speed

The actual operation speed is "operation speed 1 × override setting."

Operation speed 1 can be changed using the operation speed change function except under the following conditions.

→ For change of the operation speed, refer to Section 7.6

- During deceleration operation
- When the speed change disable during operation signal is ON.

3. Address Specification

The absolute/relative address can be specified.

With the specified absolute address: Specifies a target address (position) using address 0 as the base.

With the specified relative address: Specifies a travel distance from the current address.

4. Rotation Direction

With the specified absolute address: The rotation direction depends on whether the target address 1 is larger or smaller than the current address.

With the specified relative address: The rotation direction is decided by the sign (positive/negative) of target address 1.

9.7 Variable Speed Operation

- For details on the operation speed change, refer to Section 7.6
- For details on the torque limit, refer to Subsection 7.9.3
- For details on the STOP command, refer to Section 7.4
- For setting of ring operation in the current address, refer to Section 7.8

1. Operation

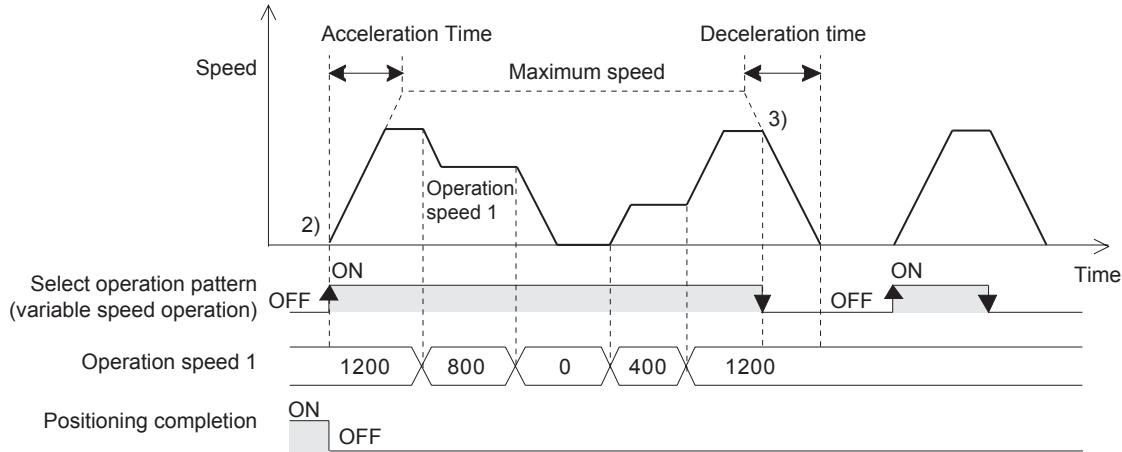

- 1) Set the operation speed 1 to a value other than 0.
- 2) Select the variable speed operation from the patterns to start the variable speed operation (above figure). (The positioning completion signal is turned OFF.)
- 3) When the variable speed operation selected as the operation pattern is set to OFF, the motor decelerates and stops, and finishes the variable speed operation. (Positioning completion signal remains OFF.)

→ For the parameters, control data and monitor data, refer to Chapter 11

		BFM Number		Data type
		X-axis	Y-axis	
Operation speed 1		BFM #503,#502	BFM #603,#602	Control data
Variable speed operation	Operation pattern selection	BFM #520 b5	BFM #620 b5	Control data
STOP command	Operation command 1	BFM #518 b1	BFM #618 b1	Control data
Acceleration/deceleration time change command (Ver.1.30 or later)	Operation command 2	BFM #519 b5	BFM #619 b5	Control data
Ring operation rotation direction for absolute address (Ver.1.10 or later)		BFM #530	BFM #630	Control data
Positioning completion	Status information	BFM #28 b6	BFM #128 b6	Monitor data
READY/BUSY	Status information	BFM #28 b0	BFM #128 b0	Monitor data
Received target speed (Ver.1.20 or later)		BFM #27,#26	BFM #127,#126	Monitor data
Current address (user)		BFM #1,#0	BFM #101,#100	Monitor data
Current address (pulse)		BFM #3,#2	BFM #103,#102	Monitor data
Real current address (user) (Ver.1.20 or later)		BFM #21,#20	BFM #121,#120	Monitor data
Real current address (pulse) (Ver.1.20 or later)		BFM #23,#22	BFM #123,#122	Monitor data
Operation speed present value		BFM #11,#10	BFM #111,#110	Monitor data
System of units (user unit)	Operation parameter 1	BFM #14000 b1,b0	BFM #14200 b1,b0	Positioning parameters
Unit of measurement for the user units	Operation parameter 1	BFM #14000 b3,b2	BFM #14200 b3,b2	Positioning parameters
Position data magnification	Operation parameter 1	BFM #14000 b5,b4	BFM #14200 b5,b4	Positioning parameters
Acceleration/deceleration mode	Operation parameter 1	BFM #14000 b11	BFM #14200 b11	Positioning parameters
Servo end check enabled/disabled	Operation parameter 2	BFM #14002 b0	BFM #14202 b0	Positioning parameters
Servo ready check enabled/disabled	Operation parameter 2	BFM #14002 b1	BFM #14202 b1	Positioning parameters

- 1 Introduction
- 2 System configuration
- 3 Specifications
- 4 Installation
- 5 Wiring
- 6 Memory Config. and data operation
- 7 Before starting positioning operation
- 8 Manual control
- 9 Positioning Control
- 10 Table Operation

		BFM Number		Data type
		X-axis	Y-axis	
Ring counter setting (Ver. 1.10 or later)	Operation parameter 2	BFM #14002 b3	BFM #14202 b3	Positioning parameters
Pulse rate		BFM #14005,#14004	BFM #14205,#14204	Positioning parameters
Feed rate		BFM #14007,#14006	BFM #14207,#14206	Positioning parameters
Maximum speed		BFM #14009,#14008	BFM #14209,#14208	Positioning parameters
Acceleration time		BFM #14018	BFM #14218	Positioning parameters
Deceleration time		BFM #14020	BFM #14220	Positioning parameters
Servo end evaluation time		BFM #14032	BFM #14232	Positioning parameters
Ring counter upper limit value (Ver. 1.10 or later)		BFM #14101,#14100	BFM #14301,#14300	Positioning parameters
Positioning completion signal output waiting time (Ver. 1.20 or later)		BFM #14106	BFM #14306	Positioning parameters
Acceleration time 2 (Ver. 1.30 or later)		BFM #14108	BFM #14308	Positioning parameters
Deceleration time 2 (Ver. 1.30 or later)		BFM #14110	BFM #14310	Positioning parameters

Note

- When setting the operation speed to 0, the work piece decelerates to stop, but the variable speed operation does not end.
When terminating the operation, turn OFF the variable speed operation in the operation pattern.
- At STOP command ON, the work piece decelerates to stop.
Note that the operation restarts at STOP command OFF.
- Even if the current address overflows, no error occurs.
- The current address may overflow during unlimited length feed operation.
No error occurs even if the current address overflows, but note that the current address changes "from the maximum value to the minimum value" or "from the minimum value to the maximum value."

2. Operation speed

The actual operation speed is "operation speed 1 x override setting."

→ **For the override function, refer to Subsection 7.6.1**

3. Rotation Direction

The operation direction is decided by the sign of operation speed 1.

+ : Operates in the direction which increases the current value. (Decelerates to stop when the value is 0.)

- : Operates in the direction which decreases the current value.

If the sign of the operation speed value changes, the reverse operation starts after decelerating to stop.

Caution

An abrupt change in the rotation direction may cause damage to the machine.

It may also cause an error through motor overload.

To change the rotation direction, set operation speed 1 value to 0, and wait for the motor to stop completely after decelerating to stop.

If operation speed 1 value changes from positive to negative (e.g. 100 → -100), the work piece decelerates to stop, and the 20SSC-H starts the reverse operation immediately.

9.8 Multi-Speed Operation

The multi-speed operation is a positioning procedure, available only in the table operation.
For details on controlling by table operation, and changing the operation speed, refer to the following sections.

- For details on the table operation, refer to Chapter 10
- For details on the operation speed change, refer to Section 7.6
- For details on the torque limit, refer to Subsection 7.9.3
- For details on the STOP command, refer to Section 7.4
- For setting of ring operation in the current address, refer to Section 7.8

1. Operation

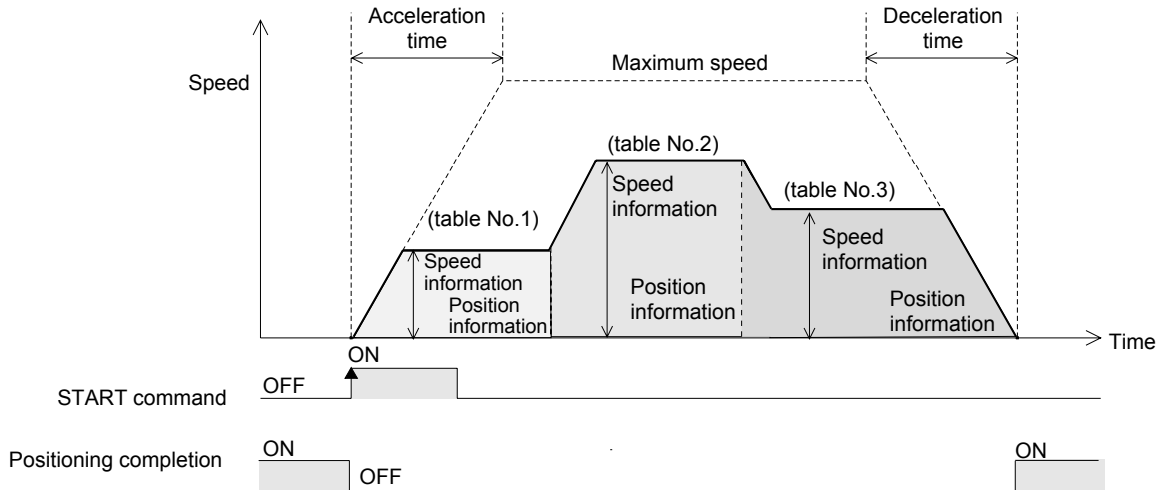

- 1) Set the operation information, speed information, and position (address) information for each table.
 - X-, Y-axis table information: Sets Multi-speed operation to Operation information.
 - XY-axes table information: Sets X-axis multi-speed operation or Y-axis multi-speed operation to Operation information individually.
(Even if performing multi-speed operation using XY-axes table information, the X-axis and the Y-axis operate independently of each other.)
- 2) Set "table operation (individual)" or "table operation (simultaneous)" in accordance with the table information used in "operation pattern selection."
- 3) Set the table number which specifies multi-speed operation to "table operation start number", and set the START command from OFF to ON.
The system will start positioning operation for the specified table number. (The positioning completion signal is set to OFF.)
- 4) The operation continuously executes the table positioning until the END command. (above figure)
- 5) The work piece decelerates to stop at the specified position (address) in the table before the END command. When the operation ends, the positioning completion signal turns ON.
→ For the parameters, control data and monitor data, refer to Chapter 11
→ For details on the table operation, refer to Chapter 10

	BFM Number		Data type	
	X-axis	X-axis		
Table information (X-axis)	BFM #1000 to #3999	-	Table information	
Table information (Y-axis)	-	BFM #4000 to #6999	Table information	
Table information (XY-axis)	BFM #7000 to #12999		Table information	
Table operation (individual)	Operation pattern selection	BFM #520 b9	BFM #620 b9	Control data
Table operation (simultaneous)	Operation pattern selection	BFM #520 b10	BFM #620 b10	Control data
Table operation start number		BFM #521	BFM #621	Control data
STOP command	Operation command 1	BFM #518 b1	BFM #618 b1	Control data
START command	Operation command 1	BFM #518 b9	BFM #618 b9	Control data
Simultaneous START flag	Operation command 1	BFM #518 b10		Control data

- 1 Introduction
- 2 System configuration
- 3 Specifications
- 4 Installation
- 5 Wiring
- 6 Memory Config and data operation
- 7 Before starting positioning operation
- 8 Manual control
- 9 Positioning Control
- 10 Table Operation

		BFM Number		Data type
		X-axis	Y-axis	
m code OFF	Operation command 1	BFM #518 b11	BFM #618 b11	Control data
Change command in operation disabled	Operation command 1	BFM #518 b12	BFM #618 b12	Control data
Speed change command in positioning operation	Operation command 1	BFM #518 b13	BFM #618 b13	Control data
Remaining distance operation cancel command	Operation command 2	BFM #519 b0	BFM #619 b0	Control data
Acceleration/deceleration time change command (Ver. 1.30 or later)	Operation command 2	BFM #519 b5	BFM #619 b5	Control data
Ring operation rotation direction for absolute address (Ver. 1.10 or later)		BFM #530	BFM #630	Control data
X-START(Input terminal)		-	-	Input terminal
Y-START(Input terminal)		-	-	Input terminal
m code number		BFM #9	BFM #109	Monitor data
Number of the table in operation		BFM #16	BFM #116	Monitor data
Positioning completion	Status information	BFM #28 b6	BFM #128 b6	Monitor data
READY/BUSY	Status information	BFM #28 b0	BFM #128 b0	Monitor data
Standby for remaining travel distance at stop	Status information	BFM #28 b7	BFM #128 b7	Monitor data
During table operation execution	Status information	BFM #28 b15	BFM #128 b15	Monitor data
Received target address (Ver. 1.20 or later)		BFM #25,#24	BFM #125,#124	Monitor data
Received target speed (Ver. 1.20 or later)		BFM #27,#26	BFM #127,#126	Monitor data
Current address (user)		BFM #1,#0	BFM #101,#100	Monitor data
Current address (pulse)		BFM #3,#2	BFM #103,#102	Monitor data
Real current address (user) (Ver. 1.20 or later)		BFM #21,#20	BFM #121,#120	Monitor data
Real current address (pulse) (Ver. 1.20 or later)		BFM #23,#22	BFM #123,#122	Monitor data
Operation speed present value		BFM #11,#10	BFM #111,#110	Monitor data
System of units (user unit)	Operation parameter 1	BFM #14000 b1,b0	BFM #14200 b1,b0	Positioning parameters
Unit of measurement for the user units	Operation parameter 1	BFM #14000 b3,b2	BFM #14200 b3,b2	Positioning parameters
Position data magnification	Operation parameter 1	BFM #14000 b5,b4	BFM #14200 b5,b4	Positioning parameters
Acceleration/deceleration mode	Operation parameter 1	BFM #14000 b11	BFM #14200 b11	Positioning parameters
STOP mode	Operation parameter 1	BFM #14000 b15	BFM #14200 b15	Positioning parameters
Servo end check enabled/disabled	Operation parameter 2	BFM #14002 b0	BFM #14202 b0	Positioning parameters
Servo ready check enabled/disabled	Operation parameter 2	BFM #14002 b1	BFM #14202 b1	Positioning parameters
Ring counter setting (Ver. 1.10 or later)	Operation parameter 2	BFM #14002 b3	BFM #14202 b3	Positioning parameters
Pulse rate		BFM #14005,#14004	BFM #14205,#14204	Positioning parameters
Feed rate		BFM #14007,#14006	BFM #14207,#14206	Positioning parameters
Maximum speed		BFM #14009,#14008	BFM #14209,#14208	Positioning parameters
Acceleration time		BFM #14018	BFM #14218	Positioning parameters
Deceleration time		BFM #14020	BFM #14220	Positioning parameters
Servo end evaluation time		BFM #14032	BFM #14232	Positioning parameters
Ring counter upper limit value (Ver. 1.10 or later)		BFM #14101,#14100	BFM #14301,#14300	Positioning parameters
Positioning completion signal output waiting time (Ver. 1.20 or later)		BFM #14106	BFM #14306	Positioning parameters
Acceleration time 2 (Ver. 1.30 or later)		BFM #14108	BFM #14308	Positioning parameters
Deceleration time 2 (Ver. 1.30 or later)		BFM #14110	BFM #14310	Positioning parameters

POINT

- In multi-speed operation, preparation for the next table number operation is performed simultaneously with the current operation.
If a travel distance to shift the operation speed is less than the pulses to accelerate/decelerate, or if the travel time is too short (at 50 ms or less), the current operation does not continue and temporarily stops.
- When using m code in multi-speed operation, use the With mode.
With the m code in After mode, operation does not continue from the table since the 20SSC-H suspends the operation shift to the next table until the m code turns OFF .
- Multi-speed operation ends if another operation information is performed during the multi-speed operation.
- Multi-speed operation operates independently in the X-axis and the Y-axis.
Even if performing multi-speed operation using XY-axes table information, only the setup for X-axis multi-speed operation or Y-axis multi-speed operation is used.

Setting example of XY-axes table information

No.	Command code	Address x:[PLS] y:[PLS]	Speed fx:[Hz] fy:[Hz]	Arc center i:[PLS] j:[PLS]	Arc radius r:[PLS]	Time [10ms]	Jump No.	m code
0	X-axis operation at multi-step speed	x: 5000	fx: 1000					-1
1	X-axis operation at multi-step speed	x: 15000	fx: 2000					-1
2	X-axis operation at multi-step speed	x: 30000	fx: 3000					-1
⋮	⋮	⋮	⋮	⋮	⋮	⋮	⋮	⋮
10	Y-axis operation at multi-step speed	y: 15000	fy: 3000					-1
11	Y-axis operation at multi-step speed	y: 20000	fy: 1000					-1
12	Y-axis operation at multi-step speed	y: 30000	fy: 3000					-1

2. Operation information

Set multi-speed operation, absolute address specification, relative address specification and the End command in the operation information.

→ For details, refer to Chapter 10

3. Speed information

The actual operation speed is "operation speed 1 × override setting."

Operation speed 1 can be changed using the operation speed change function except under the following conditions.

→ For change of the operation speed, refer to Section 7.6

- During deceleration operation
- When the speed change disable during operation signal is ON.

4. Position (address) information

The absolute/relative address can be specified in the operation information.

With the specified absolute address: Specifies a target address (position) using address 0 as the base.

With the specified relative address: Specifies a travel amount from the current address.

5. Rotation Direction

With the specified absolute address: The rotation direction depends on whether the position (address) information is larger or smaller than the current address.

With the specified relative address: The rotation direction is decided by the sign (positive/negative) of position (address) information.

1 Introduction
2 System configuration
3 Specifications
4 Installation
5 Wiring
6 Memory Config and data operation
7 Before starting positioning operation
8 Manual control
9 Positioning Control
10 Table Operation

6. Speed switching

Speed switching is classified into "standard switching" and "front-load switching". In the FX3U-20SSC-H, the speed is switched by standard switching. (Refer to the figure below.)

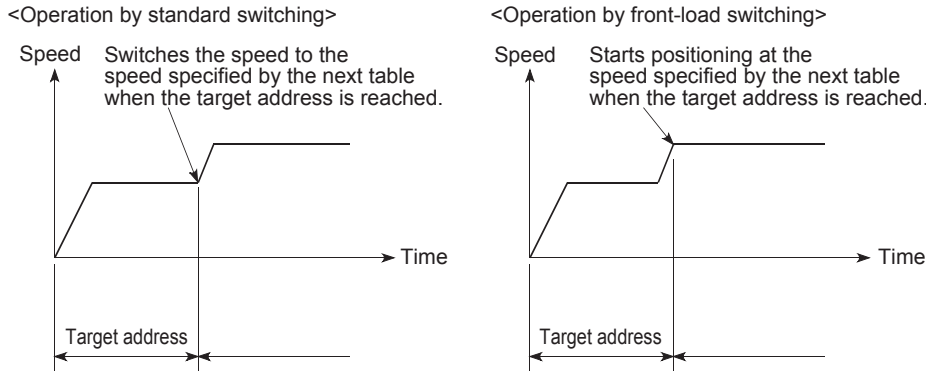

9.9 Linear Interpolation Operation

- For details on the operation speed change, refer to Section 7.6
- For details on the torque limit, refer to Subsection 7.9.3
- For details on the STOP command, refer to Section 7.4
- For details on the table operation, refer to Chapter 10

1. Operation

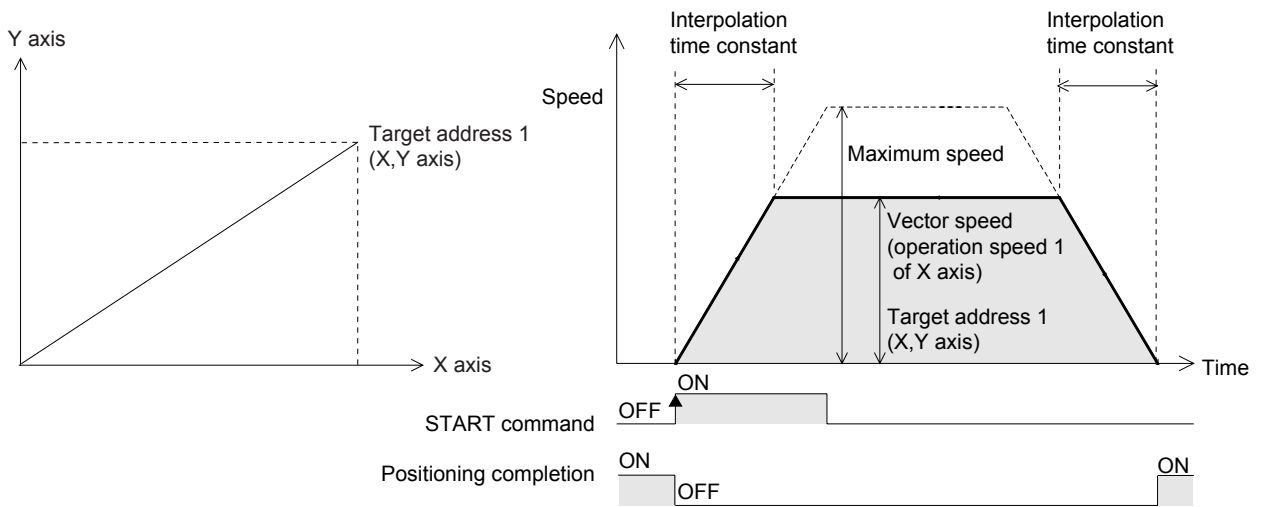

- 1) Set the operation speed 1 for the X-axis and the target address 1 for the X/Y-axis.
- 2) Select the linear interpolation operation from the X-axis and Y-axis operation patterns and turn ON the START command for the X-axis. The linear interpolation operation shown above will operate at the specified vector speed (X-axis operation speed 1). (The positioning completion signal is turned OFF.) The START command of the Y-axis is ignored.
- 3) The work piece stops at the XY coordinate in target address 1, and the operation ends, turning the positioning completion signal ON.

→ For the parameters, control data and monitor data, refer to Chapter 11

		BFM Number		Data type
		X-axis	Y-axis	
Target address 1		BFM #501,#500	BFM #601,#600	Control data
Operation speed 1		BFM #503,#502	BFM #603,#602 ^{*1}	Control data
Linear interpolation	Operation pattern selection	BFM #520 b7	BFM #620 b7	Control data
STOP command	Operation command 1	BFM #518 b1	BFM #618 b1 ^{*1}	Control data
Relative/absolute address specification	Operation command 1	BFM #518 b8	BFM #618 b8 ^{*1}	Control data

		BFM Number		Data type
		X-axis	Y-axis	
START command	Operation command 1	BFM #518 b9	BFM #618 b9 ^{*1}	Control data
Change command in operation disabled	Operation command 1	BFM #518 b12	BFM #618 b12 ^{*1}	Control data
Speed change command in positioning operation	Operation command 1	BFM #518 b13	BFM #618 b13 ^{*1}	Control data
Remaining distance operation cancel command	Operation command 2	BFM #519 b0	BFM #619 b0 ^{*1}	Control data
X-START (Input terminal)		-	-	Input terminal
Positioning completion	Status information	BFM #28 b6	BFM #128 b6	Monitor data
READY/BUSY	Status information	BFM #28 b0	BFM #128 b0	Monitor data
Standby for remaining travel distance at stop	Status information	BFM #28 b7	BFM #128 b7	Monitor data
Received target address (Ver.1.20 or later)		BFM #25,#24	BFM #125,#124	Monitor data
Received target speed (Ver.1.20 or later)		BFM #27,#26	BFM #127,#126 ^{*1}	Monitor data
Current address (user)		BFM #1,#0	BFM #101,#100	Monitor data
Current address (pulse)		BFM #3,#2	BFM #103,#102	Monitor data
Real current address (user) (Ver.1.20 or later)		BFM #21,#20	BFM #121,#120	Monitor data
Real current address (pulse) (Ver.1.20 or later)		BFM #23,#22	BFM #123,#122	Monitor data
Operation speed present value		BFM #11,#10	BFM #111,#110 ^{*1}	Monitor data
System of units (user unit)	Operation parameter 1	BFM #14000 b1,b0	BFM #14200 b1,b0	Positioning parameters
Unit of measurement for the user units	Operation parameter 1	BFM #14000 b3,b2	BFM #14200 b3,b2	Positioning parameters
Position data magnification	Operation parameter 1	BFM #14000 b5,b4	BFM #14200 b5,b4	Positioning parameters
Acceleration/deceleration mode ^{*2}	Operation parameter 1	BFM #14000 b11	BFM #14200 b11	Positioning parameters
STOP mode	Operation parameter 1	BFM #14000 b15	BFM #14200 b15	Positioning parameters
Servo end check enabled/disabled	Operation parameter 2	BFM #14002 b0	BFM #14202 b0	Positioning parameters
Servo ready check enabled/disabled	Operation parameter 2	BFM #14002 b1	BFM #14202 b1	Positioning parameters
Interpolation gear ratio selection ^{*3} (Ver.1.20 or later)	Operation parameter 2	BFM #14002 b14		Positioning parameters
Pulse rate ^{*3}		BFM #14005,#14004	BFM #14205,#14204	Positioning parameters
Feed rate ^{*3}		BFM #14007,#14006	BFM #14207,#14206	Positioning parameters
Maximum speed		BFM #14009,#14008	BFM #14209,#14208 ^{*1}	Positioning parameters
Interpolation time constant		BFM #14022	BFM #14222 ^{*1}	Positioning parameters
Servo end evaluation time		BFM #14032	BFM #14232	Positioning parameters
Positioning completion signal output waiting time (Ver.1.20 or later)		BFM #14106	BFM #14306	Positioning parameters

- *1. Shaded columns are invalid for interpolation operation.
- *2. In interpolation operation, the system performs trapezoidal acceleration/deceleration even if approximate S-shaped acceleration/deceleration is selected.
- *3. For cautions on setting the pulse rate and feed rate in interpolation operation, refer to the following.
→ **Refer to Subsection 7.11.3**

POINT

- When using linear interpolation operation, the operation pattern selection should set in both axes as linear interpolation.
If the same operation pattern is not set in both axes, the following operation is executed.
 - 1) When linear interpolation is set to the operation pattern of the X-axis and a different operation pattern is set to the Y-axis
The operation pattern of the Y-axis is disregarded, and linear interpolation operation is executed.
 - 2) When an operation pattern different than linear interpolation is set to the operation pattern of the X-axis and linear interpolation is set to the Y-axis
X-axis: Operates by the operation pattern set in the X-axis.
Y-axis: Does not operate.
- The positioning completion signal turns ON if the travel distance is 0.
If the travel distance is 0 or the travel time is too short, however, it is impossible for the sequence program to detect the positioning completion signal turning OFF.*4
*4. Turning OFF of the positioning completion signal can be detected when the positioning completion signal output waiting time is set if the version is Ver. 1.20 or later.
→ **For details on the Positioning completion signal output waiting time, refer to Subsection 7.9.11**
- When interpolation operations are consecutively repeated in a table operation, the 20SSC-H provides continuous pass operation.
→ **For details on the continuous pass operation, refer to Section 10.10**
- Pulse rate and feed rate
In versions earlier than Ver. 1.20, make sure that the ratio between the pulse rate and the feed rate is equivalent between the X-axis and the Y-axis.
In versions Ver. 1.20 or later, if the ratio between the pulse rate and the feed rate is not equivalent between the X-axis and the Y-axis, set "interpolation gear ratio selection" to "X/Y-axis."
→ **For selection of the interpolation gear ratio, refer to Subsection 7.11.3**

2. Operation speed

The actual operation speed (vector speed) is "X-axis operation speed 1 x X-axis override setting."

Operation speed 1 for the X-axis can be changed using the operation speed change function except under the following conditions.

→ **For change of the operation speed, refer to Section 7.6**

- During deceleration operation
- When the speed change disable during operation signal is ON.

3. Address specification

The absolute/relative address can be specified.

With the specified absolute address: Specifies a target address (position) using address 0 as the base.

With the specified relative address: Specifies a travel amount from the current address.

4. Rotation Direction

With the specified absolute address: The rotation direction depends on whether the target address 1 is larger or smaller than the current address.

With the specified relative address: The rotation direction is decided by the sign (positive/negative) of target address 1.

9.10 Linear Interpolation Operation (Interrupt Stop)

- For details on the operation speed change, refer to Section 7.6
- For details on the torque limit, refer to Subsection 7.9.3
- For details on the STOP command, refer to Section 7.4
- For details on the table operation, refer to Chapter 10

1. Operation

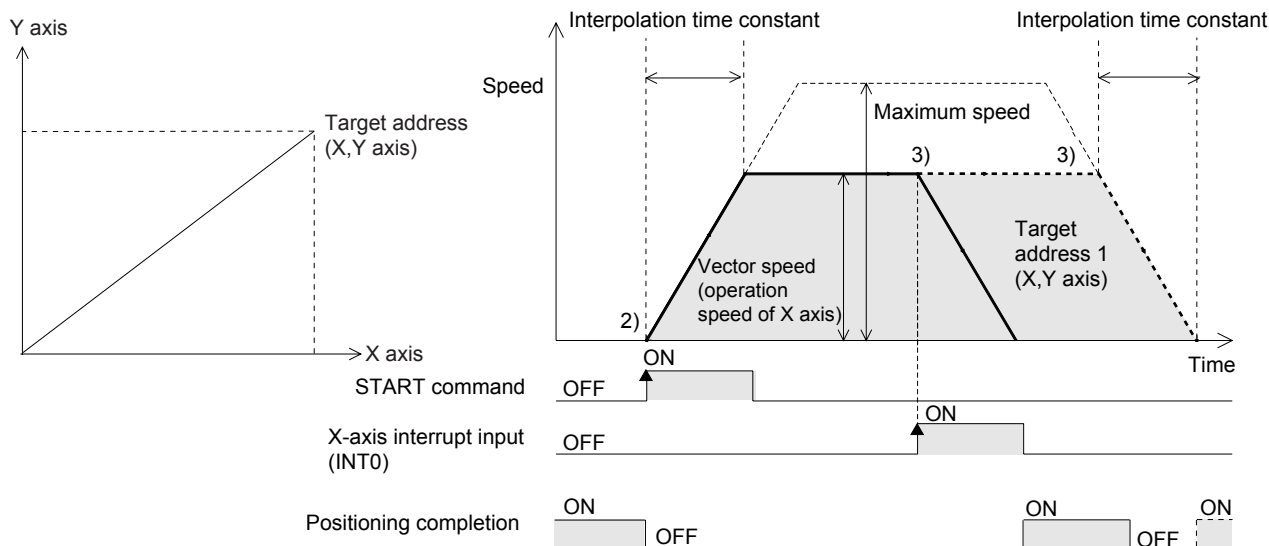

- 1) Set the operation speed 1 for the X-axis and target address 1 (maximum travel distance) for the X/Y-axis.
- 2) Select the linear interpolation operation (interrupt stop) from the X-axis and Y-axis operation patterns and turn ON the START command for the X-axis. The linear interpolation operation (interrupt stop) shown above will operate at the specified vector speed (X-axis operation speed 1). (The positioning completion signal is turned OFF.)
The START command of the Y-axis is ignored.
- 3) At interrupt input (INT0) ON before the XY coordinate in target address 1, the work piece decelerates to stop, and the operation ends, turning the positioning completion signal ON.
When the interrupt input (INT0) does not turn ON before the XY coordinate in target address 1, the work piece moves to target address 1, and the operation ends, turning the positioning completion signal ON.
In a 20SSC-H Ver. 1.30 or later, the current address when an interrupt input (INT0) occurs is stored in the "current address when an interrupt occurs (INT0)."

→ For the parameters, control data and monitor data, refer to Chapter 11

		BFM Number		Data type
		X-axis	Y-axis	
Target address 1		BFM #501,#500	BFM #601,#600	Control data
Operation speed 1		BFM #503,#502	BFM #603,#602 ^{*1}	Control data
Linear interpolation (interrupt stop)	Operation pattern selection	BFM #520 b8	BFM #620 b8	Control data
STOP command	Operation command 1	BFM #518 b1	BFM #618 b1 ^{*1}	Control data
Relative/absolute address specification	Operation command 1	BFM #518 b8	BFM #618 b8 ^{*1}	Control data
START command	Operation command 1	BFM #518 b9	BFM #618 b9 ^{*1}	Control data
Change command in operation disabled	Operation command 1	BFM #518 b12	BFM #618 b12 ^{*1}	Control data
Speed change command in positioning operation	Operation command 1	BFM #518 b13	BFM #618 b13 ^{*1}	Control data
Remaining distance operation cancel command	Operation command 2	BFM #519 b0	BFM #619 b0 ^{*1}	Control data
X-START(Input terminal)		-	-	Input terminal
X-INT0(Input terminal)		-	-	Input terminal
Positioning completion	Status information	BFM #28 b6	BFM #128 b6	Monitor data
READY/BUSY	Status information	BFM #28 b0	BFM #128 b0	Monitor data

- 1 Introduction
- 2 System configuration
- 3 Specifications
- 4 Installation
- 5 Wiring
- 6 Memory Config¹ and data operation
- 7 Before starting positioning operation
- 8 Manual control
- 9 Positioning Control
- 10 Table Operation

		BFM Number		Data type
		X-axis	Y-axis	
Standby for remaining travel distance at stop	Status information	BFM #28,b7	BFM #128,b7	Monitor data
Received target address (Ver.1.20 or later)		BFM #25,#24	BFM #125,#124	Monitor data
Received target speed (Ver.1.20 or later)		BFM #27,#26	BFM #127,#126 ^{*1}	Monitor data
Current address (user)		BFM #1,#0	BFM #101,#100	Monitor data
Current address (pulse)		BFM #3,#2	BFM #103,#102	Monitor data
Real current address (user) (Ver.1.20 or later)		BFM #21,#20	BFM #121,#120	Monitor data
Real current address (pulse) (Ver.1.20 or later)		BFM #23,#22	BFM #123,#122	Monitor data
Operation speed present value		BFM #11,#10	BFM #111,#110 ^{*1}	Monitor data
Current address when an interrupt occurs (INT0) (Ver.1.30 or later) ^{*2}		BFM #35,#34	BFM #135,#134	Monitor data
System of units (user unit)	Operation parameter 1	BFM #14000 b1,b0	BFM #14200 b1,b0	Positioning parameters
Unit of measurement for the user units	Operation parameter 1	BFM #14000 b3,b2	BFM #14200 b3,b2	Positioning parameters
Position data magnification	Operation parameter 1	BFM #14000 b5,b4	BFM #14200 b5,b4	Positioning parameters
Acceleration/deceleration mode ^{*3}	Operation parameter 1	BFM #14000 b11	BFM #14200 b11	Positioning parameters
STOP mode	Operation parameter 1	BFM #14000 b15	BFM #14200 b15	Positioning parameters
Servo end check enabled/disabled	Operation parameter 2	BFM #14002 b0	BFM #14202 b0	Positioning parameters
Servo ready check enabled/disabled	Operation parameter 2	BFM #14002 b1	BFM #14202 b1	Positioning parameters
Interpolation gear ratio selection ^{*4} (Ver.1.20 or later)	Operation parameter 2	BFM #14002 b14		Positioning parameters
Pulse rate ^{*4}		BFM #14005,#14004	BFM #14205,#14204	Positioning parameters
Feed rate ^{*4}		BFM #14007,#14006	BFM #14207,#14206	Positioning parameters
Maximum speed		BFM #14009,#14008	BFM #14209,#14208 ^{*1}	Positioning parameters
Interpolation time constant		BFM #14022	BFM #14222 ^{*1}	Positioning parameters
Servo end evaluation time		BFM #14032	BFM #14232	Positioning parameters
Positioning completion signal output waiting time (Ver.1.20 or later)		BFM #14106	BFM #14306	Positioning parameters

*1. Shaded columns are invalid for interpolation operation.

*2. The error in the calculation of user units is included in the value of the current address when an interrupt occurs.

*3. In interpolation operation, the system performs trapezoidal acceleration/deceleration even if approximate S-shaped acceleration/deceleration is selected.

*4. For cautions on setting the pulse rate and feed rate in interpolation operation, refer to the following.

→ **Refer to Subsection 7.11.3**

Note

- When using linear interpolation operation (interrupt stop), the operation pattern selection should set in both axes as linear interpolation (interrupt stop).
If the same operation pattern is not set in both axes, the following operation is executed.
 - 1) When linear interpolation (interrupt stop) is set to the operation pattern of the X-axis and a different operation pattern is set to the Y-axis
The operation pattern of the Y-axis is disregarded, and linear interpolation operation (interrupt stop) is executed.
 - 2) When an operation pattern different than linear interpolation (interrupt stop) is set to the operation pattern of the X-axis and linear interpolation (interrupt stop) is set to the Y-axis
X-axis: Operates by the operation pattern set in the X-axis.
Y-axis: Does not operate.
- When interpolation operations are consecutively repeated in a table operation, the 20SSC-H provides continuous pass operation.
→ **For details on the continuous pass operation, refer to Section 10.10**
- Pulse rate and feed rate
In versions earlier than Ver. 1.20, make sure that the ratio between the pulse rate and the feed rate is equivalent between the X-axis and the Y-axis.
In versions Ver. 1.20 or later, if the ratio between the pulse rate and the feed rate is not equivalent between the X-axis and the Y-axis, set "interpolation gear ratio selection" to "X/Y-axis."
→ **For selection of the interpolation gear ratio, refer to Subsection 7.11.3**

2. Operation speed

The actual operation speed (vector speed) is "X-axis operation speed 1 x X-axis override setting."

The operation speed 1 for the X-axis can be changed using the operation speed change function except under the following conditions.

→ **For change of the operation speed, refer to Section 7.6**

- During deceleration operation
- When the speed change disable during operation signal is ON.

3. Address specification

The absolute/relative address can be specified.

With the specified absolute address: Specifies a target address (position) using address 0 as the base.

With the specified relative address: Specifies a travel amount from the current address.

4. Rotation Direction

With the specified absolute address: The rotation direction depends on whether the target address 1 is larger or smaller than the current address.

With the specified relative address: The rotation direction is decided by the sign (positive/negative) of target address 1.

9.11 Circular Interpolation Operation

The circular interpolation operation is a positioning procedure, available only in the table operation.

The circular interpolation operation has the center coordinate specification/radius specification formats.

For details on controlling by table operation, and changing the operation speed, refer to the following sections.

- For details on the table operation, refer to Chapter 10
- For details on the operation speed change, refer to Section 7.6
- For details on the torque limit, refer to Subsection 7.9.3
- For details on the STOP command, refer to Section 7.4
- For details on the radius specification, refer to Subsection 9.11.2

9.11.1 Circular interpolation [center coordinate specification]

The work piece moves from the start point to the target address, following the circular arc locus around the specified center coordinate.

1. Operation

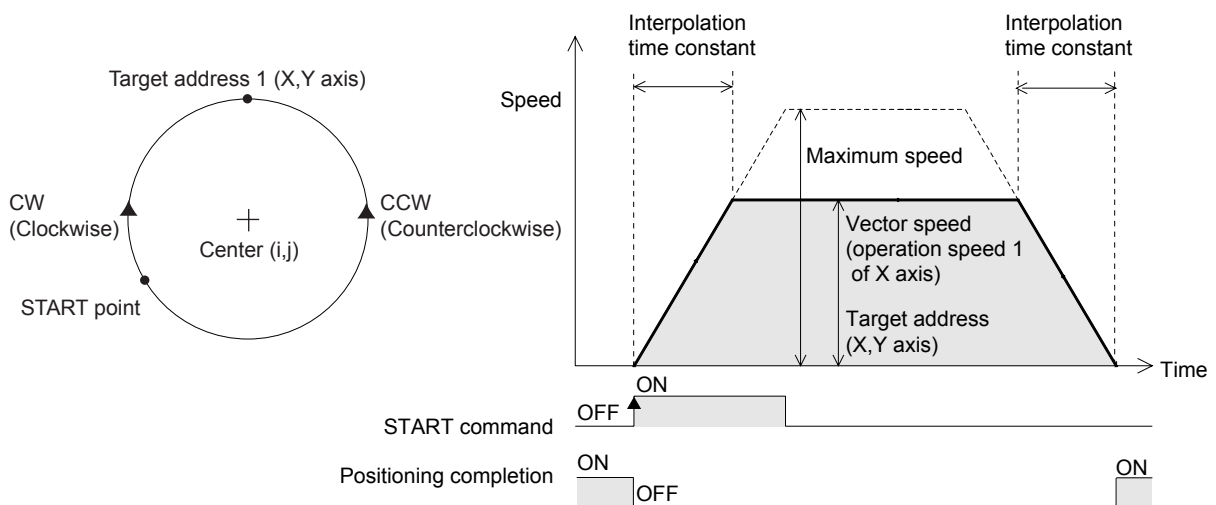

- 1) Set table information, X-axis speed, X/Y axis position (address) information and center coordinate in the XY table information.
- 2) Set "table operation (simultaneous)" in the operation pattern selection.
- 3) When turning the X-axis START command ON at the table operation start number with the specified circular interpolation (center, CW direction) / (center, CCW direction), the work piece moves to the target position at the specified speed, following the circle's center coordinate.
- 4) The work piece stops at the XY coordinate in target address 1, and the operation ends, turning the positioning completion signal ON.

→ For the parameters, control data and monitor data, refer to Chapter 11

→ For details on the table operation, refer to Chapter 10

		BFM Number		Data type
		X-axis	Y-axis	
Table information (XY-axis)		BFM #7000 to #12999		Table information
Table operation (simultaneous)	Operation pattern selection	BFM #520 b10	BFM #620 b10	Control data
Table operation start number		BFM #521	BFM #621 ^{*1}	Control data
STOP command	Operation command 1	BFM #518 b1	BFM #618 b1 ^{*1}	Control data
START command	Operation command 1	BFM #518 b9	BFM #618 b9 ^{*1}	Control data
m code OFF	Operation command 1	BFM #518 b11	BFM #618 b11 ^{*1}	Control data
Change command in operation disabled	Operation command 1	BFM #518 b12	BFM #618 b12 ^{*1}	Control data
Speed change command in positioning operation	Operation command 1	BFM #518 b13	BFM #618 b13 ^{*1}	Control data

		BFM Number		Data type
		X-axis	Y-axis	
Remaining distance operation cancel command	Operation command 2	BFM #519 b0	BFM #619 b0 ^{*1}	Control data
X-START(Input terminal)		-	-	Input terminal
m code number		BFM #9	BFM #109 ^{*1}	Monitor data
Number of the table in operation		BFM #16	BFM #116 ^{*1}	Monitor data
Positioning completion	Status information	BFM #28 b6	BFM #128 b6	Monitor data
READY/BUSY	Status information	BFM #28 b0	BFM #128 b0	Monitor data
Standby for remaining travel distance at stop	Status information	BFM #28 b7	BFM #128 b7	Monitor data
Received target address (Ver.1.20 or later)		BFM #25,#24	BFM #125,#124	Monitor data
Received target speed (Ver.1.20 or later)		BFM #27,#26	BFM #127,#126 ^{*1}	Monitor data
Current address (user)		BFM #1,#0	BFM #101,#100	Monitor data
Current address (pulse)		BFM #3,#2	BFM #103,#102	Monitor data
Real current address (user) (Ver.1.20 or later)		BFM #21,#20	BFM #121,#120	Monitor data
Real current address (pulse) (Ver.1.20 or later)		BFM #23,#22	BFM #123,#122	Monitor data
Operation speed present value		BFM #11,#10	BFM #111,#110 ^{*1}	Monitor data
System of units (user unit)	Operation parameter 1	BFM #14000 b1,b0	BFM #14200 b1,b0	Positioning parameters
Unit of measurement for the user units	Operation parameter 1	BFM #14000 b3,b2	BFM #14200 b3,b2	Positioning parameters
Position data magnification	Operation parameter 1	BFM #14000 b5,b4	BFM #14200 b5,b4	Positioning parameters
Acceleration/deceleration mode ^{*2}	Operation parameter 1	BFM #14000 b11	BFM #14200 b11	Positioning parameters
STOP mode	Operation parameter 1	BFM #14000 b15	BFM #14200 b15	Positioning parameters
Servo end check enabled/disabled	Operation parameter 2	BFM #14002 b0	BFM #14202 b0	Positioning parameters
Servo ready check enabled/disabled	Operation parameter 2	BFM #14002 b1	BFM #14202 b1	Positioning parameters
Interpolation gear ratio selection ^{*3} (Ver.1.20 or later)	Operation parameter 2	BFM #14002 b14		Positioning parameters
Pulse rate ^{*3}		BFM #14005,#14004	BFM #14205,#14204	Positioning parameters
Feed rate ^{*3}		BFM #14007,#14006	BFM #14207,#14206	Positioning parameters
Maximum speed		BFM #14009,#14008	BFM #14209,#14208 ^{*1}	Positioning parameters
Interpolation time constant		BFM #14022	BFM #14222 ^{*1}	Positioning parameters
Servo end evaluation time		BFM #14032	BFM #14232	Positioning parameters
Positioning completion signal output waiting time (Ver.1.20 or later)		BFM #14106	BFM #14306	Positioning parameters

- *1. Shaded columns are invalid for interpolation operation.
- *2. In interpolation operation, the system performs trapezoidal acceleration/deceleration even if approximate S-shaped acceleration/deceleration is selected.
- *3. For cautions on setting the pulse rate and feed rate in interpolation operation, refer to the following.
→ **Refer to Subsection 7.11.3**

Note

- The center coordinate is always handled as a relative address from the start point.
- When setting the same address for the start and target points, the work piece moves in a perfect circle. The center coordinate specification is available in the perfect circle operation.
- Pulse rate and feed rate
Set ratios that are the same for the pulse rate to the feed rate for the X-axis and the Y-axis if the version is earlier than Ver.1.20. Set the interpolation gear ratio selection function in the X- axis, Y-axis when the ratio of the pulse rate to the feed rate differs between the X-axis and the Y-axis for versions Ver.1.20 or later.
→ **For details on the interpolation gear ratio selection, refer to Subsection 7.11.3**
- During continuous pass operation
If the circular path is too short and the travel time from the start point to the target point is shorter than the interpolation time constant, the operation temporarily stops and shifts to the next interpolation operation.
- When interpolation operations are consecutively repeated in a table operation, the 20SSC-H provides continuous pass operation.
→ **For details on the continuous pass operation, refer to Section 10.10**

2. Operation information

Set a circular interpolation operation ("center, CW direction" or "center, CCW direction") and an absolute/relative address in the operation information.

3. Speed information

The actual operation speed (vector speed) is "X-axis operation speed 1 x X-axis override setting."

The operation speed 1 for the X-axis can be changed using the operation speed change function except under the following conditions.

→ **For change of the operation speed, refer to Section 7.6**

- During deceleration operation
- When the speed change disable during operation signal is ON.

4. Position (address) information

The absolute/relative address can be specified in the operation information.

With the specified absolute address: Specifies a target address (position) using address 0 as the base.

With the specified relative address: Specifies a travel amount from the current address.

5. Circle information (center coordinate)

Set the center coordinate (i, j) by a relative address from the start point.

9.11.2 Circular interpolation [radius specification]

The work piece moves in a circular arc with a specified radius from the start point to the target address.

1. Operation

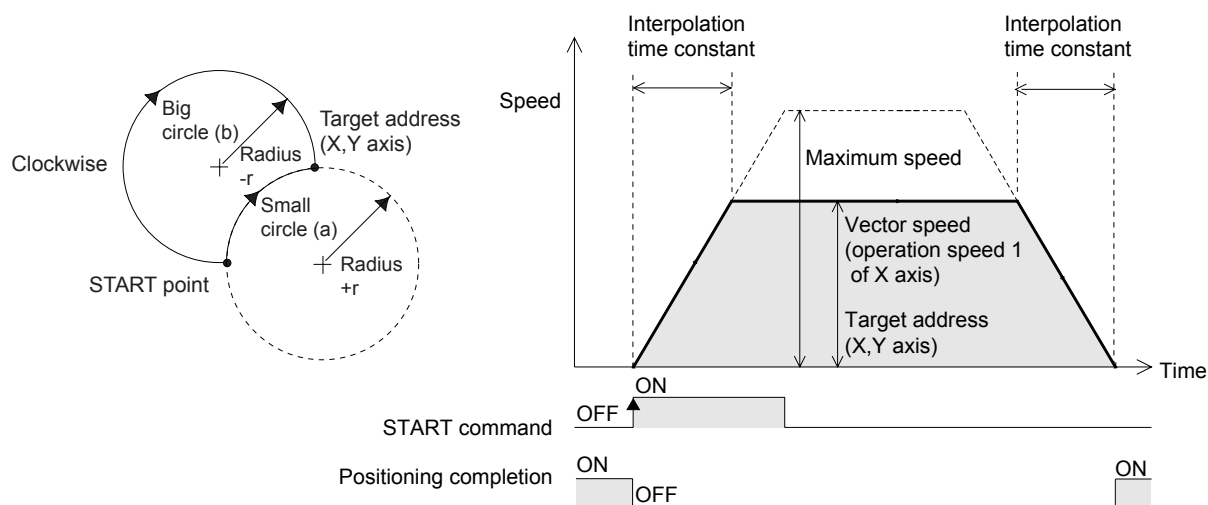

- 1) Set the table information, X-axis speed, X/Y axis position (address) and radius in the XY table information.
- 2) When turning the X-axis START command ON at the table operation start number with the specified circular interpolation (radius, CW direction) / (radius, CCW direction), the work piece moves to the target position at the specified speed, following the circle's center coordinate calculated from the start point, target position and radius.
- 3) The work piece stops at the XY coordinate in the target address 1, and the operation ends, turning the positioning completion signal ON.

→ For the parameters, control data and monitor data, refer to Chapter 11

→ For details on the table operation, refer to Chapter 10

		BFM Number		Data type
		X-axis	Y-axis	
Table information (XY-axis)		BFM #7000 to #12999		Table information
Table operation (simultaneous)	Operation pattern selection	BFM #520 b10	BFM #620 b10	Control data
Table operation start number		BFM #521	BFM #621 ^{*1}	Control data
STOP command	Operation command 1	BFM #518 b1	BFM #618 b1 ^{*1}	Control data
START command	Operation command 1	BFM #518 b9	BFM #618 b9 ^{*1}	Control data
m code OFF	Operation command 1	BFM #518 b11	BFM #618 b11 ^{*1}	Control data
Change command in operation disabled	Operation command 1	BFM #518 b12	BFM #618 b12 ^{*1}	Control data
Speed change command in positioning operation	Operation command 1	BFM #518 b13	BFM #618 b13 ^{*1}	Control data
Remaining distance operation cancel command	Operation command 2	BFM #519 b0	BFM #619 b0 ^{*1}	Control data
X-START(Input terminal)		-	-	Input terminal
m code number		BFM #9	BFM #109 ^{*1}	Monitor data
Number of the table in operation		BFM #16	BFM #116 ^{*1}	Monitor data
Positioning completion	Status information	BFM #28 b6	BFM #128 b6	Monitor data
READY/BUSY	Status information	BFM #28 b0	BFM #128 b0	Monitor data
Standby for remaining travel distance at stop	Status information	BFM #28 b7	BFM #128 b7	Monitor data
Received target address (Ver.1.20 or later)		BFM #25,#24	BFM #125,#124	Monitor data
Received target speed (Ver.1.20 or later)		BFM #27,#26	BFM #127,#126 ^{*1}	Monitor data
Current address (user)		BFM #1,#0	BFM #101,#100	Monitor data

		BFM Number		Data type
		X-axis	Y-axis	
Current address (pulse)		BFM #3,#2	BFM #103,#102	Monitor data
Real current address (user) (Ver.1.20 or later)		BFM #21,#20	BFM #121,#120	Monitor data
Real current address (pulse) (Ver.1.20 or later)		BFM #23,#22	BFM #123,#122	Monitor data
Operation speed present value		BFM #11,#10	BFM #111,#110 ^{*1}	Monitor data
System of units (user unit)	Operation parameter 1	BFM #14000 b1,b0	BFM #14200 b1,b0	Positioning parameters
Unit of measurement for the user units	Operation parameter 1	BFM #14000 b3,b2	BFM #14200 b3,b2	Positioning parameters
Position data magnification	Operation parameter 1	BFM #14000 b5,b4	BFM #14200 b5,b4	Positioning parameters
Acceleration/deceleration mode ^{*2}	Operation parameter 1	BFM #14000 b11	BFM #14200 b11	Positioning parameters
STOP mode	Operation parameter 1	BFM #14000 b15	BFM #14200 b15	Positioning parameters
Servo end check enabled/disabled	Operation parameter 2	BFM #14002 b0	BFM #14202 b0	Positioning parameters
Servo ready check enabled/disabled	Operation parameter 2	BFM #14002 b1	BFM #14202 b1	Positioning parameters
Interpolation gear ratio selection ^{*3} (Ver.1.20 or later)	Operation parameter 2	BFM #14002 b14		Positioning parameters
Pulse rate ^{*3}		BFM #14005,#14004	BFM #14205,#14204	Positioning parameters
Feed rate ^{*3}		BFM #14007,#14006	BFM #14207,#14206	Positioning parameters
Maximum speed		BFM #14009,#14008	BFM #14209,#14208 ^{*1}	Positioning parameters
Interpolation time constant		BFM #14022	BFM #14222 ^{*1}	Positioning parameters
Servo end evaluation time		BFM #14032	BFM #14232	Positioning parameters
Positioning completion signal output waiting time (Ver.1.20 or later)		BFM #14106	BFM #14306	Positioning parameters

*1. Shaded columns are invalid in interpolation operation.

*2. In interpolation operation, the system performs trapezoidal acceleration/deceleration even if approximate S-shaped acceleration/deceleration is selected.

*3. For cautions on setting the pulse rate and feed rate in interpolation operation, refer to the following.

→ **Refer to Subsection 7.11.3**

Note

- The radius is specified as r. When r is a positive value, the small circle (a) path is selected and when it is negative, the big circle (b) path is selected.
- Pulse rate and feed rate
During the circular interpolation operation, the radius value is kept constant and pulses are allocated to the X and Y axes. If the ratio of the pulse rate to the feed rate differs between the X-axis and Y-axis, the circle becomes deformed. Set the interpolation gear ratio selection function in the X- axis, Y-axis when the ratio differs between the X-axis and the Y-axis if the version is Ver. 1.20 or later.
→ **For details on the interpolation gear ratio selection, refer to Subsection 7.11.3**
- Use the center coordinate specification in a perfect circle operation.
- During continuous pass operation
If the circular path is too short and the travel time from the start point to the target point is shorter than the interpolation time constant, the operation temporarily stops, and shifts to the next interpolation operation.
- When interpolation operations are consecutively repeated in a table operation, the 20SSC-H provides continuous pass operation.
→ **For details on the continuous pass operation, refer to Section 10.10**
- Setting error (error code: 6) may occur when the conversion of the starting point, target position, and radius into pulse units do not make a circle.
In this case, please use center coordinate specification.

2. Operation information

Set a circular interpolation operation ("radius, CW direction" or "radius, CCW direction") and an absolute/relative address in the operation information.

→ For details, refer to Chapter 10

3. Speed information

The actual operation speed (vector speed) is "X-axis operation speed 1 x X-axis override setting."

The operation speed 1 for the X-axis can be changed using the operation speed change function except under the following conditions.

→ For change of the operation speed, refer to Section 7.6

- During deceleration operation
- When the speed change disable during operation signal is ON.

4. Position (address) information

The absolute/relative address can be specified in the operation information.

With the specified absolute address: Specifies a target address (position) using address 0 as the base.

With the specified relative address: Specifies a travel amount from the current address.

5. Circle information (radius)

Set the radius of a circle with by r.

With specified positive (+) value: Operates the small circle (a) path.

With specified negative (-) value: Operates the big circle (b) path.

1

Introduction

2System
configuration**3**

Specifications

4

Installation

5

Wiring

6Memory Config.
and data
operation**7**Before starting
positioning
operation**8**

Manual control

9Positioning
Control**10**

Table Operation

9.12 Reciprocal movement instruction (Ver.1.10 or later)

→ For change of the operation speed and target address, refer to Section 7.6

→ For details on the torque limit, refer to Subsection 7.9.3

→ For details on the STOP command, refer to Section 7.4

→ For setting of ring operation in the current address, refer to Section 7.8

1. Operation

When "reciprocal movement instruction" is set in the operation pattern selection, the system starts reciprocal movements, and performs as follows in accordance with the status of the open signal (INT0), close signal (INT1) and closing/opening operation.

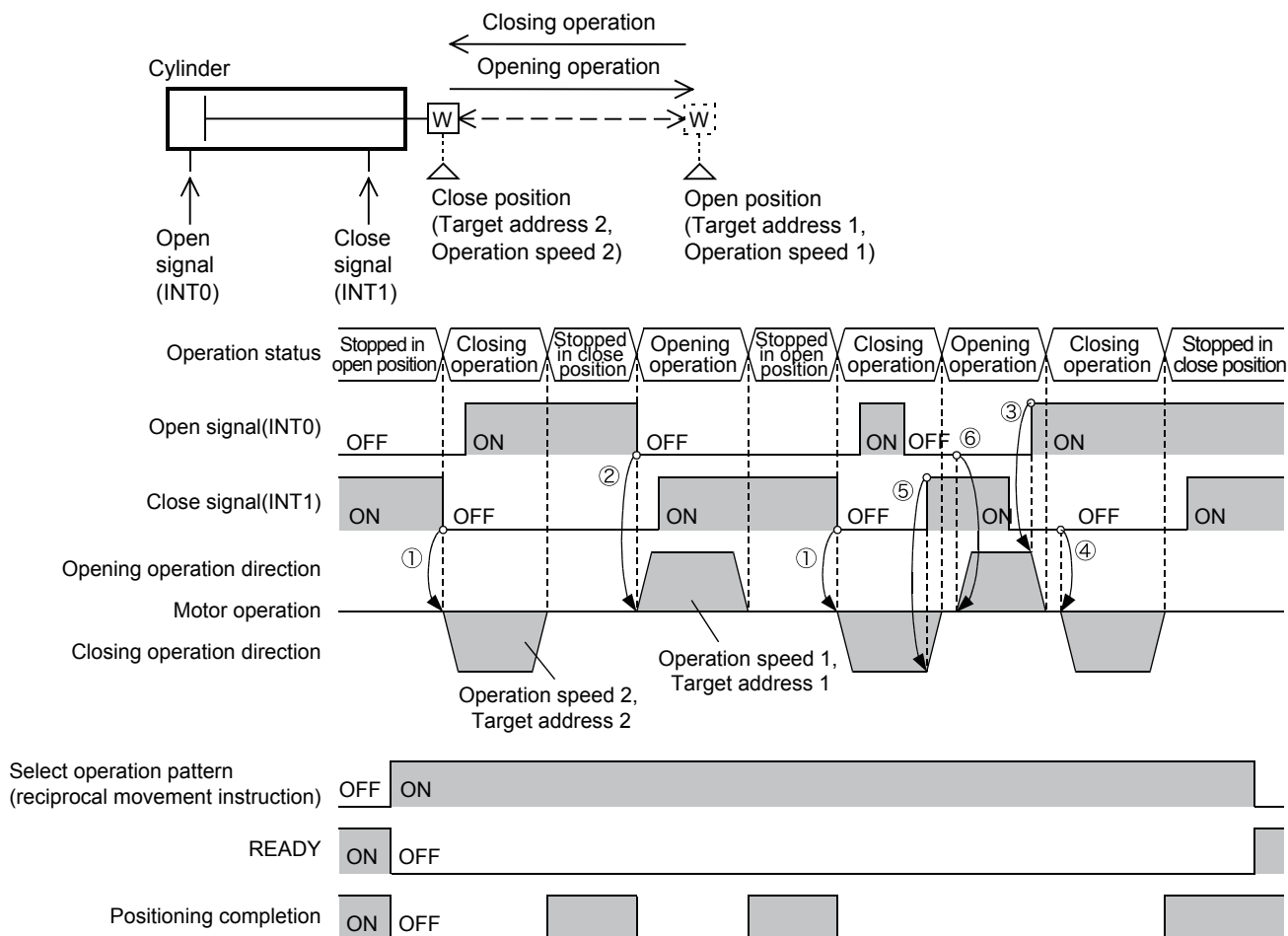

- Stopped in the open position
 - Close signal (INT1) = ON: The system remains stopped in the open position.
 - Close signal (INT1) = OFF: The system starts closing operation (① above). (The system starts to move toward target address 2 at operation speed 2.)
- Stopped in the close position
 - Open signal (INT0) = ON: The system remains stopped in the close position.
 - Open signal (INT0) = OFF: The system starts opening operation (② above). (The system starts to move toward target address 1 at operation speed 1.)

- Opening operation
When the open signal is set to ON from OFF, the system decelerates and stops opening operation (③ above).
After deceleration stop, the system performs as follows in accordance with the status of the open signal (INT0) and close signal (INT1).
 - Close signal (INT1) = OFF: The system starts closing operation (④ above).
(The system starts to move toward target address 2 at operation speed 2.)
 - Close signal (INT1) = ON, open signal (INT0) = ON: The system remains stopped in the stopped position.
 - Close signal (INT1) = ON, open signal (INT0) = OFF: The system starts opening operation.
(The system starts to move toward target address 1 at operation speed 1.)
- Closing operation
When the close signal is set to ON from OFF, the system decelerates and stops closing operation (⑤ above).
After deceleration stop, the system performs as follows in accordance with the status of the open signal (INT0) and close signal (INT1).
 - Open signal (INT0) = OFF: The system starts opening operation (⑥ above).
(The system starts to move toward target address 1 at operation speed 1.)
 - Open signal (INT0) = ON, close signal (INT1) = ON: The system remains stopped in the stopped position.
 - Open signal (INT0) = ON, close signal (INT1) = OFF: The system starts closing operation. (The system starts to move toward target address 2 at operation speed 2.)

→ For the parameters, control data and monitor data, refer to Chapter 11

		BFM Number		Data type
		X-axis	Y-axis	
Target address 1		BFM #501,#500	BFM #601,#600	Control data
Operation speed 1		BFM #503,#502	BFM #603,#602	Control data
Target address 2		BFM #505,#504	BFM #605,#604	Control data
Operation speed 2		BFM #507,#506	BFM #607,#606	Control data
Reciprocal movement instruction (Ver.1.10 or later)	Operation pattern selection	BFM #520 b11	BFM #620 b11	Control data
STOP command	Operation command 1	BFM #518 b1	BFM #618 b1	Control data
Simultaneous START flag	Operation command 1	BFM #518 b10		Control data
Change command in operation disabled	Operation command 1	BFM #518 b12	BFM #618 b12	Control data
Speed change command in positioning operation	Operation command 1	BFM #518 b13	BFM #618 b13	Control data
Target position change command in positioning operation	Operation command 1	BFM #518 b14	BFM #618 b14	Control data
Remaining distance operation cancel command	Operation command 2	BFM #519 b0	BFM #619 b0	Control data
Acceleration/deceleration time change command (Ver.1.30 or later)	Operation command 2	BFM #519 b5	BFM #619 b5	Control data
Ring operation rotation direction for absolute address (Ver.1.10 or later)		BFM #530	BFM #630	Control data
X-INT0(Input terminal)		-	-	Input terminal
Y-INT0(Input terminal)		-	-	Input terminal
X-INT1(Input terminal)		-	-	Input terminal
Y-INT1(Input terminal)		-	-	Input terminal
Positioning completion	Status information	BFM #28 b6	BFM #128 b6	Monitor data
READY/BUSY	Status information	BFM #28 b0	BFM #128 b0	Monitor data

		BFM Number		Data type
		X-axis	Y-axis	
Standby for remaining travel distance at stop	Status information	BFM #28,b7	BFM #128,b7	Monitor data
Received target address (Ver.1.20 or later)		BFM #25,#24	BFM #125,#124	Monitor data
Received target speed (Ver.1.20 or later)		BFM #27,#26	BFM #127,#126	Monitor data
Current address (user)		BFM #1,#0	BFM #101,#100	Monitor data
Current address (pulse)		BFM #3,#2	BFM #103,#102	Monitor data
Real current address (user) (Ver.1.20 or later)		BFM #21,#20	BFM #121,#120	Monitor data
Real current address (pulse) (Ver.1.20 or later)		BFM #23,#22	BFM #123,#122	Monitor data
Operation speed present value		BFM #11,#10	BFM #111,#110	Monitor data
System of units (user unit)	Operation parameter 1	BFM #14000 b1,b0	BFM #14200 b1,b0	Positioning parameters
Unit of measurement for the user units	Operation parameter 1	BFM #14000 b3,b2	BFM #14200 b3,b2	Positioning parameters
Position data magnification	Operation parameter 1	BFM #14000 b5,b4	BFM #14200 b5,b4	Positioning parameters
Acceleration/deceleration mode	Operation parameter 1	BFM #14000 b11	BFM #14200 b11	Positioning parameters
STOP mode	Operation parameter 1	BFM #14000 b15	BFM #14200 b15	Positioning parameters
Servo end check enabled/disabled	Operation parameter 2	BFM #14002 b0	BFM #14202 b0	Positioning parameters
Servo ready check enabled/disabled	Operation parameter 2	BFM #14002 b1	BFM #14202 b1	Positioning parameters
Ring counter setting (Ver.1.10 or later)	Operation parameter 2	BFM #14002 b3	BFM #14202 b3	Positioning parameters
Pulse rate		BFM #14005,#14004	BFM #14205,#14204	Positioning parameters
Feed rate		BFM #14007,#14006	BFM #14207,#14206	Positioning parameters
Maximum speed		BFM #14009,#14008	BFM #14209,#14208	Positioning parameters
Acceleration time		BFM #14018	BFM #14218	Positioning parameters
Deceleration time		BFM #14020	BFM #14220	Positioning parameters
Servo end evaluation time		BFM #14032	BFM #14232	Positioning parameters
Ring counter upper limit value (Ver. 1.10 or later)		BFM #14101,#14100	BFM #14301,#14300	Positioning parameters
Positioning completion signal output waiting time (Ver.1.20 or later)		BFM #14106	BFM #14306	Positioning parameters
Acceleration time 2 (Ver.1.30 or later)		BFM #14108	BFM #14308	Positioning parameters
Deceleration time 2 (Ver.1.30 or later)		BFM #14110	BFM #14310	Positioning parameters

Note

- When the 20SSC-H completes positioning in the open or close position, the positioning completion signal turns ON.
- The READY status remains OFF while the 20SSC-H is operating, and turns ON when the 20SSC-H finishes operation.
- The motor decelerates and stops when the operation pattern selection (reciprocal movement instruction) is set to OFF.
- When changing the address to a newly specified one during control using the target address change function, the target address after change becomes valid when the target address 1 or target address 2 is changed at the same time.
 - When changing the target address (open position) during the opening operation, change the target address 1 at the same time.
 - When changing the target address (close position) during the closing operation, change the target address 2 at the same time.
- When using the reciprocal movement instruction in ring operation, set the ring operation direction for absolute address to "0: Direction for shorter rotation."

2. Operation speed

The actual operation speed is decided by the following calculation formulas.

- Operation speed1 × Override setting
- Operation speed2 × Override setting

The actual operation speed 1 and operation speed 2 can be changed using the operation speed change function except under the following conditions.

→ **For change of the operation speed, refer to Section 7.6**

- During deceleration operation
- When the speed change disable during operation signal is ON.

3. Address specification

Specified address are handled as absolute address.
(The absolute/relative address specification is ignored.)

4. Rotation Direction

The rotation direction is determined by the relationship among the current address, target address 1 and target address 2.

1

Introduction

2

System
configuration

3

Specifications

4

Installation

5

Wiring

6

Memory Config.
and data
operation

7

Before starting
positioning
operation

8

Manual control

9

Positioning
Control

10

Table Operation

10. Table Operation

10.1 Outline of Table Operation

This section describes the table information setting and table operation motions.

For details on the positioning commands available with the table operation, refer to the following.

→ For details on each positioning operation, refer to Chapter 9

About the table operation

The "table operation" executes preset positioning operation patterns from the table information. Positioning operations are consecutively executed and may be arranged in any order. A few positioning operations are only available in table operation.

Positioning operations for table operation only

- Multi-speed operation
- Circular interpolation
- Continuous pass operation

10.1.1 Applicable positioning operations for table operation

- | | |
|--|---|
| <ul style="list-style-type: none"> • Applicable positioning operations for table operation <ul style="list-style-type: none"> - 1-speed positioning operation - Interrupt 1-speed constant quantity feed - 2-speed positioning operation - Interrupt 2-speed constant quantity feed - Interrupt stop - Multi-speed operation - Linear interpolation^{*1} - Linear interpolation (interrupt stop)^{*1} - Circular interpolation^{*1} - Mechanical zero return | <ul style="list-style-type: none"> • Inapplicable positioning operations for table operation <ul style="list-style-type: none"> - Variable speed operation - Manual pulse generator - JOG operation - Reciprocal movement instruction (Ver.1.10 or later) |
|--|---|

*1. When interpolation operations are consecutively repeated in a table operation, the 20SSC-H provides continuous pass operation.

→ For details on continuous operation, refer to Section 10.10

10.1.2 Types of table information and number of registered tables

Type of table information	Number of registered tables	Table number
X-axis table information	300 tables	0 to 299
Y-axis table information	300 tables	0 to 299
XY-axis table information	300 tables	0 to 299

10.1.3 Table information setting items

1. Setting items and contents

Setting item	Content	Type of table information		
		X-axis	Y-axis	XY-axis
Operation information*1	Sets a positioning operation in the table operation along with a current address change, etc. <ul style="list-style-type: none"> - No processing - m code - End - 1-speed positioning - Interrupt 1-speed constant quantity feed - 2-speed positioning - Interrupt 2-speed constant quantity feed - Interrupt stop - Multi-speed operation (requires multiple tables) - Linear interpolation - Linear interpolation (interrupt stop) - Circular interpolation (center, CW direction) - Circular interpolation (center, CCW direction) - Circular interpolation (radius, CW direction) - Circular interpolation (radius, CCW direction) - Mechanical zero return - Current address change - Absolute address specification - Relative address specification - Dwell - Jump 	✓	✓	✓
Position information (x,y)	Sets the following items depending on the settings in the operation information. <ul style="list-style-type: none"> • In positioning operations Set the target address Setting range: -2,147,483,648 to 2,147,483,647 (user unit)*2 Set the value within -2,147,483,648 to 2,147,483,647PLS in converted pulse data. • In current address changes Set the new current address. Setting range: -2,147,483,648 to 2,147,483,647 (user unit)*2 Set the value within -2,147,483,648 to 2,147,483,647PLS in converted pulse data. • In Dwell Set a dwell time. Setting range: 0 to 32767(×10ms) • In Jump Set the jump No. table. Setting range: 0 to 299 	✓	✓	✓
Speed information (fx,f,fy)	Set the operation speed. Setting range: 1 to 50,000,000 (user unit)*2 Set the value within 1 to 50,000,000Hz in converted pulse data.	✓	✓	✓
Circle information (i,r,j)	Set the center coordinate and radius of the circle during circular interpolation operation. Setting range: -2,147,483,648 to 2,147,483,647 (user unit)*2 Set the value within -2,147,483,648 to 2,147,483,647PLS in converted pulse data.	-	-	✓
m code information*3	Sets m codes. <ul style="list-style-type: none"> • No m code-1 • After-mode m code 0 to 9999 • With-mode m code 10000 to 32767 	✓	✓	✓

- *1. Set a numeric value suitable for each operation to the operation information stored in the buffer memory.
→ For set values and setting items in operation information, refer to the next page
- *2. For details on the user units, refer to the following.
→ Refer to Section 7.10
- *3. The m code is an auxiliary command to support positioning data in execution.
For details on m code, refer to the following.
→ Refer to Section 10.9

1 Introduction

2 System configuration

3 Specifications

4 Installation

5 Wiring

6 Memory Config. and data operation

7 Before starting positioning operation

8 Manual control

9 Positioning Control

10 Table Operation

2. Operation information and setting items

Set the numeric value corresponding to each operation to the operation information in the buffer memory. The table below shows the target table information, set value and other setting items (position information, speed information, circle information and "m" code information) for each item in the operation information.

Operation information				Setting target table information			Other setting items							Remarks
							Position information		Speed information		Circle information		m code information	
Name	Operation target axis	Symbol	Setting value	X-axis	Y-axis	XY-axis	x	y	fx/f	fy	i/r	j		
No processing	-	NOP	-1	✓	✓	✓	-	-	-	-	-	-	-	No operation
m code	-	NOP	-1	✓	✓	✓	-	-	-	-	-	-	✓	Sets the m code only.
End	-	END	0	✓	✓	✓	-	-	-	-	-	-	-	Terminates the table operation.
1-speed positioning operation	X-axis	DRV_X	1	✓	-	✓	✓	-	✓	-	-	-	✓	For the positioning operation details, refer to Section 9.2.
	Y-axis	DRV_Y	2	-	✓	✓	-	✓	-	✓	-	-	✓	
	XY-axis	DRV_XY	3	-	-	✓	✓	✓	✓	✓	-	-	✓	
Interrupt constant quantity feed	X-axis	SINT_X	4	✓	-	✓	✓	-	✓	-	-	-	✓	For the positioning operation details, refer to Section 9.3.
	Y-axis	SINT_Y	5	-	✓	✓	-	✓	-	✓	-	-	✓	
	XY-axis	SINT_XY	6	-	-	✓	✓	✓	✓	✓	-	-	✓	
2-speed positioning operation (2 table rows used)	X-axis	DRV2_X	7	✓	-	✓	✓	-	✓	-	-	-	✓	For the positioning operation details, refer to Section 9.4.
		DRV2_Y	8	-	✓	✓	-	✓	-	✓	-	-	✓	
	XY-axis	DRV2_XY	9	-	-	✓	✓	✓	✓	✓	-	-	✓	
							✓	✓	✓	✓	-	-	-	
Interrupt constant quantity feed (2 table rows used)	X-axis	DINT_X	10	✓	-	✓	✓	-	✓	-	-	-	✓	For the positioning operation details, refer to Section 9.5.
		DINT_Y	11	-	✓	✓	-	✓	-	✓	-	-	✓	
	XY-axis	DINT_XY	12	-	-	✓	✓	✓	✓	✓	-	-	✓	
							✓	✓	✓	✓	-	-	-	
Interrupt stop	X-axis	INT_X	13	✓	-	✓	✓	-	✓	-	-	-	✓	For the positioning operation details, refer to Section 9.6.
	Y-axis	INT_Y	14	-	✓	✓	-	✓	-	✓	-	-	✓	
	XY-axis	INT_XY	15	-	-	✓	✓	✓	✓	✓	-	-	✓	
Multi-speed operation (requires multiple tables used)	X-axis	DRVC_X	16	✓	-	✓	✓	-	✓	-	-	-	✓	For the positioning operation details, refer to Section 9.8.
	Y-axis	DRVC_Y	17	-	✓	✓	-	✓	-	✓	-	-	✓	
Linear interpolation	XY-axis	LIN	19	-	-	✓	✓	✓	✓	-	-	-	✓	For the positioning operation details, refer to Section 9.9.
Linear interpolation (Interrupt stop)	XY-axis	LIN_INT	20	-	-	✓	✓	✓	✓	-	-	-	✓	For the positioning operation details, refer to Section 9.10.
Circular interpolation (center, CW direction)	XY-axis	CW_i	21	-	-	✓	✓	✓	✓	-	✓	✓	✓	For the positioning operation details, refer to Subsection 9.11.1.
Circular interpolation (center, CCW direction)	XY-axis	CCW_i	22	-	-	✓	✓	✓	✓	-	✓	✓	✓	

Operation information				Setting target table information			Other setting items							Remarks
							Position information		Speed information		Circle information		m code information	
Name	Operation target axis	Symbol	Setting value	X-axis	Y-axis	XY-axis	x	y	fx/f	fy	i/r	j		
Circular interpolation (radius, CW direction)	XY-axis	CW_r	23	-	-	✓	✓	✓	✓	-	✓	-	✓	For the positioning operation details, refer to Subsection 9.11.2.
Circular interpolation (radius, CCW direction)	XY-axis	CCW_r	24	-	-	✓	✓	✓	✓	-	✓	-	✓	
Mechanical zero return operation	X-axis	DRVZ_X	25	✓	-	✓	-	-	-	-	-	-	✓	For the positioning operation details, refer to Section 8.1.
	Y-axis	DRVZ_Y	26	-	✓	✓	-	-	-	-	-	-	✓	
	XY-axis	DRVZ_XY	27	-	-	✓	-	-	-	-	-	-	✓	
Changes the current address	X-axis	SET_X	90	✓	-	✓	✓	-	-	-	-	-	✓	Changes the current address (user). Refer to Subsection 7.9.9.
	Y-axis	SET_Y	91	-	✓	✓	-	✓	-	-	-	-	✓	
	XY-axis	SET_XY	92	-	-	✓	✓	✓	-	-	-	-	✓	
Absolute address	-	ABS	93	✓	✓	✓	-	-	-	-	-	-	✓	When this command is issued, the position information (x, y) of the table operation becomes an absolute address, which specifies positions from the (0, 0) point. (absolute address is specified by default)
Relative address	-	INC	94	✓	✓	✓	-	-	-	-	-	-	✓	When this command is issued, the position information (x, y) of the table operation becomes a relative address based on the current address.
Dwell	-	TIM	95	✓	-	-	✓	-	-	-	-	-	✓	The 20SSC-H waits for the specified time period. Use this to specify waiting time for shifting operations.
				-	✓	-	-	✓	-	-	-	-	✓	
				-	-	✓	✓	-	-	-	-	-	✓	
Jump	-	JMP	96	✓	-	-	✓	-	-	-	-	-	-	Jumps to the specified table number. Jumping from an X-axis table to a Y-axis table is not allowed.
				-	✓	-	-	✓	-	-	-	-	-	
				-	-	✓	✓	-	-	-	-	-	-	

10.1.4 Table operation execution procedure

The following shows the procedure for executing a table operation.

1 Set the operation pattern and table start No. in the control data.

Item	BFM number		Content
	X-axis	Y-axis	
Operation pattern selection	BFM #520	BFM #620	b9 : Table operation (individual) Table operation is executed by X-axis table data and Y-axis table data. b10: Table operation (simultaneous) Table operation is executed by XY-axis table data.
Table operation start No.	BFM #521	BFM #621	Specify the table No. of the table operation to be executed. When setting the table operation (simultaneous) in the operation patterns, set the X-axis table operation start No. only. Setting range : 0 to 299

Note

When operating with XY-axis table information, both axes should be set as using table operation (simultaneous).

If the same operation pattern is not in both axes, the following operation is executed.

- 1) When table operation (simultaneous) is set to the operation pattern of the X-axis and a different operation pattern is set to the Y-axis
The operation pattern of the Y-axis is disregarded, and table operation (simultaneous) is executed.
- 2) When an operation pattern different than table operation (simultaneous) is set to the operation pattern of the X-axis and table operation (simultaneous) is set to the Y-axis
X-axis: Operates by the operation pattern set in the X-axis.
Y-axis: Does not operate.

Writing table operation data

Write table operation data to buffer memory beforehand, following the procedure below:

- Transfer the table information from the 20SSC-H flash memory to buffer memories (only while power ON)
→ **Refer to Chapter 6**
- Write (transfer) table data to buffer memories with FX Configurator-FP.
→ **For details on operation, refer to the FX Configurator-FP Operation Manual**
- Write table information by a sequence program.
→ **For an explanation of applied instructions, refer to the Programming Manual**
- Change (write) table information by the test function in programming tool's BFM monitor.
→ **For details on operation, refer to the programming tool Manual**

2 Reboot the START command to begin the table operation.

When operating with XY-axis table information, turn the START command of the X-axis from OFF to ON.

3 The 20SSC-H executes table operation in numerical order from the table operation start No.

The 20SSC-H executes table operation patterns in numerical order until the table No. with END command is reached in the operation information.

4 The table operation finishes when the table No. with the END command is executed.

10.2 How to Set Table Information

The 20SSC-H has 2 procedures to set table information, via FX Configurator-FP or by a sequence program.

Setting table information by sequence program

To set table information by a sequence program, write each setting to the 20SSC-H buffer memory with TO, or move instructions (MOV, etc.) for direct specification.
For details on buffer memory assignments, refer to the following.

→ Refer to Section 10.3 and 11.5

Note

It is strongly recommended to set and store table information in the flash memory via FX Configurator-FP. When table information is set by sequence program, a considerable amount of the sequence program and devices are used, which makes the program complicated and increases the scan time.

Setting table information on FX Configurator-FP

Set value with the X-axis, Y-axis, XY-axis table information edit windows in FX Configurator-FP. For details on operation with FX Configurator-FP, refer to the following manual.

→ FX Configurator-FP Operation Manual

- Operation method
 - 1) Double-click "File name"→"Edit"→"X-axis table information", "Y-axis table information" or "XY-axis table information" in the file data list.
 - 2) The selected X-axis table information, Y-axis table information or XY-axis table information edit window is displayed.

Note

Note that the procedures to set the table information from FX Configurator-FP and a sequence program are different.

- The position of the operation information is different.
 - a) Position information d) m code information
 - b) Speed information e) Circle information
 - c) Operation information

1) X-axis, Y-axis table information

- Buffer memory

Table No.	a)	b)	c)	d)
	Position information	Speed information	Operation information	m code information
0	5000	5000	7 ^{*3}	-1
1	2000	2500	7 ^{*3}	-1
2	100 ^{*1}	-	95	-1
3	0 ^{*2}	-	96	-1
4	-	-	0	-
5	0	200000	1	-1
6	-	-	0	-

*1, *2. The setting method for the following information is different.

- Dwell time
 - Buffer memory : Set in position information.
 - FX Configurator-FP: Set in Time.
- Jump point table No.
 - Buffer memory : Set in position information.
 - FX Configurator-FP: Set in Jump No.

- FX Configurator-FP

No.	Command code	a)	b)	*1	*2	d)
		Address [PLS]	Speed [Hz]	Time [10ms]	Jump No.	m code
0	Positioning at 2-step speed	5000	5000			-1
1	Positioning at 2-step speed	2000	2500			-1
2	Dwell			100		-1
3	Jump				0	
4	End					
5	Positioning at 1-step speed	0	200000			-1
6	End					
7						
∞						

*3. In 2-speed positioning operation and interrupt 2-speed constant quantity feed operation, two setting rows are required.

2) XY-axis table information
- Buffer memory

Table No.	a)		b)		e)		c)	d)
	Position information		Speed information		Circle information		Operation information	m code information
	X-axis	Y-axis	X-axis	Y-axis	X-axis	Y-axis		
0	5000	5000	5000	5000	-	-	g ²	-1
1	2000	2000	2500	2500	-	-	g ²	-1
2	100 ^{*1}	-	-	-	-	-	95	-1
3	-	-	-	-	-	-	0	-
4	-	-	-	-	-	-	-1	-
5	0	-	5000	-	-	-	1	-1
6	-	0	-	5000	-	-	2	-1
7	-	-	-	-	-	-	0	-

*1. The setting method for the following information is different.

- Dwell time
Buffer memory : Set in position information.
FX Configurator-FP: Set in Time
- Jump point table No.
Buffer memory : Set in position information.
FX Configurator-FP: Set in Jump No.

- FX Configurator-FP

No.	Command code	a)		b)		e)		Time [10ms]	Jump No.	m code
		x [PLS]	y [PLS]	fx [Hz]	fy [Hz]	i [PLS]	j [PLS]			
0	XY-axis positioning at 2-step speed	xc: 5000	yc: 5000	fx: 5000	fy: 5000					-1
1	XY-axis positioning at 2-step speed	xc: 2000	yc: 2000	fx: 2500	fy: 2500					-1
2	Dwell							100		-1
3	End									
4										
5	X-axis positioning at 1-step speed	xc: 0		fx: 5000						-1
6	Y-axis positioning at 1-step speed		yc: 0		fy: 5000					-1
7	End									
8										

*2. In 2-speed positioning operation and interrupt 2-speed constant quantity feed operation, two setting rows are required.

- 1 Introduction
- 2 System configuration
- 3 Specifications
- 4 Installation
- 5 Wiring
- 6 Memory Config¹ and data operation
- 7 Before starting positioning operation
- 8 Manual control
- 9 Positioning Control
- 10 Table Operation

10.3 Tables and BFM No. Allocation

Stores the table operation information to the 20SSC-H buffer memory. There are 2 BFM types, one for operation by individual axis (X/Y axis) and the other for XY-axis simultaneous operation.

Table No.	Items		BFM No.		
			X-axis table information	Y-axis table information	XY-axis table information
0	Position information	Position data x	BFM #1001, #1000	-	BFM #7001, #7000
		Position data y	-	BFM #4001, #4000	BFM #7003, #7002
	Speed information	Speed data f, fx	BFM #1003, #1002	-	BFM #7005, #7004
		Speed data fy	-	BFM #4003, #4002	BFM #7007, #7006
	Circle information	Center coordinate i, radius r	-	-	BFM #7009, #7008
		Center coordinate j	-	-	BFM #7011, #7010
	Operation information		BFM #1004	BFM #4004	BFM #7012
m code information		BFM #1005	BFM #4005	BFM #7013	
:					
299	Position information	Position data x	BFM #3991, #3990	-	BFM #12981, #12980
		Position data y	-	BFM #6991, #6990	BFM #12983, #12982
	Speed information	Speed data f, fx	BFM #3993, #3992	-	BFM #12985, #12984
		Speed data fy	-	BFM #6993, #6992	BFM #12987, #12986
	Circle information	Center coordinate i, radius r	-	-	BFM #12989, #12988
		Center coordinate j	-	-	BFM #12991, #12990
	Operation information		BFM #3994	BFM #6994	BFM #12992
m code information		BFM #3995	BFM #6995	BFM #12993	

Note

- The save command (BFM #523 b2 to b4) writes and stores the BFM table information in the 20SSC-H flash memory.
→ For a program example, refer to Subsection 7.1.9
- The default value for table information is "-1."
- The 20SSC-H stores the table number in execution in the executing table number (BFM #16, #116).

Caution for setting

Selecting the following patterns in the operation information requires two table rows.

- 2-speed Positioning operation
- Interrupt 2-speed constant quantity feed

In the case of X-axis, Y-axis table information

Table No.	Position information	Speed information	Operation information	m code information
0	500	500	7	-1
1	3000	300	7	-1
⋮	⋮	⋮	⋮	⋮
10	5000	500	7	-1
11	3000	1000	3	-1

One positioning operation is performed using two table rows. (*1)

When only 1 table row is set, the next table row (table No.11) is judged to be the 2nd speed of table No.10 and the operation is performed using that table information. (*2)

In the case of XY-axis table information

Table No.	Position information		Speed information		Circle data		Operation information	m code information
	X-axis	Y-axis	X-axis	Y-axis	X-axis	Y-axis		
0	5800	10000	5000	6000	-	-	9	-1
1	3000	5000	1000	1200	-	-	9	-1
⋮	⋮	⋮	⋮	⋮	⋮	⋮	⋮	⋮
10	500	1000	500	600	-	-	9	-1
11	800	1500	1000	1200	-	-	3	-1

*1

*2

10.4 Current Position Change

This operation information item changes the current address (user/pulse) value to the one specified in the position (address) information.

10.5 Absolute Address Specification

This operation information item sets the position data for subsequent table operations to be based on an absolute address system with a defined (0, 0) point.

Note

- When table operation begins, the position information data is handled by the absolute address specification (default). To use position information data with relative addresses, the operation information of positioning control must be set beforehand.
- The arc center (i , j), radius r, Interrupt 1-speed constant quantity feed, and Interrupt 2-speed constant quantity feed setting items are handled as relative addresses.

10.6 Relative address specification

This operation information item sets the position data of subsequent table operations to a relative address based on the current address.

Point

When table operation begins, the position information data is handled by the absolute address specification (default). To use position information data with relative addresses, the operation information of positioning control must be set beforehand.

10.7 Jump

When executing this operation information item, the operation jumps to the specified table No.. Note that the table No. does not jump from X-axis table information to Y-axis table information. Write the table No. of the jump point in the position information buffer memory location(s) for the applicable table information.

(With FX Configurator-FP, set the table No. of the jump point by the Jump No.)

10.8 Dwell

When executing this operation information, operation waits for the specified time. A dwell is used as a wait to move between operations.

Set the dwell time in the position information buffer memory location(s) for the applicable table information.

(With FX Configurator-FP, set the dwell by the Time.)

1

Introduction

2

System
configuration

3

Specifications

4

Installation

5

Wiring

6

Memory Config.
and data
operation

7

Before starting
positioning
operation

8

Manual control

9

Positioning
Control

10

Table Operation

10.9 m code

The m code is an auxiliary command to support positioning data in execution. When an m code turns ON in table operation, the 20SSC-H stores the table No. in monitor data as an m code number, while also turning ON the m code ON flag in status information. There are two modes for m code, after mode and with mode, and each mode has a different ON timing.

Mode	Content	m code No.
after mode	The m code turns ON when the operation of table information is completed.	0 to 9999
with mode	The m code turns ON when the operation information begins.	10000 to 32767

10.9.1 after mode

The specified m code turns ON after the operation.

1. Operation

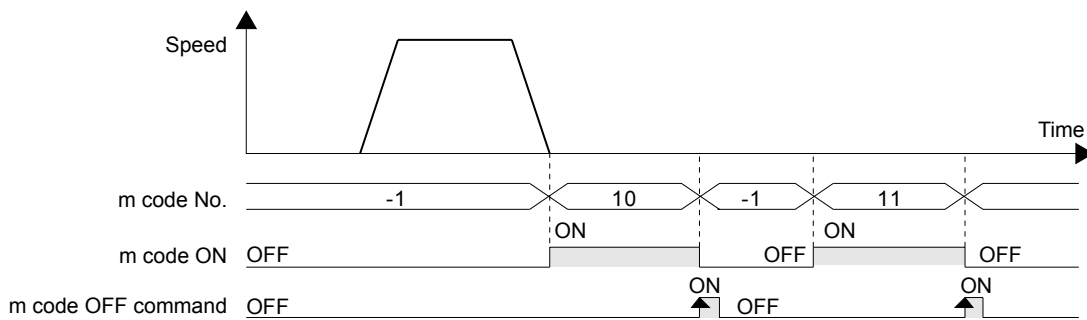

Table No.	Operation information	m code information
0	1 (1-speed positioning)	10 (after mode)
1	-1 (no processing)	11 (after mode)
2	0 (END)	-1

- 1) When the table No. 0 operation with m code "10" ends, the m code ON flag in the status information turns ON, and the 20SSC-H stores "10" in the m code No. of monitor data.
- 2) At m code OFF, the m code ON flag and m code itself turns OFF, and the 20SSC-H stores "-1" in the m code No. of monitor data.
- 3) At m code OFF, the 20SSC-H executes the next table No..

→ For the parameters, control data and monitor data, refer to Chapter 11

		BFM number		Data type
		X-axis	Y-axis	
m code OFF command	Operation command 1	BFM #518 b11	BFM #618 b11	Control data
m code number		BFM #9	BFM #109	Monitor data
Number of the table in operation		BFM #16	BFM #116	Monitor data
m code ON	Status information	BFM #28 b8	BFM #128 b8	Monitor data

Note

- With after-mode m codes in multi-speed operations and continuous pass operations, the operation does not continue the table since the 20SSC-H suspends the operation until m code OFF.
- With "0" in m code information, the 20SSC-H turns to standby mode. With start command or m code OFF command, the m code turns OFF.
- To turn only the m code ON without performing positioning operation, set "m code" to the operation information of the table information, and set the m code information.

2. Available m code Nos.

To use m code in the after mode, set the m code in the range from 0 to 9999 for the m code information.

10.9.2 with mode

The specified m code turns ON when the operation starts.

1. Operation

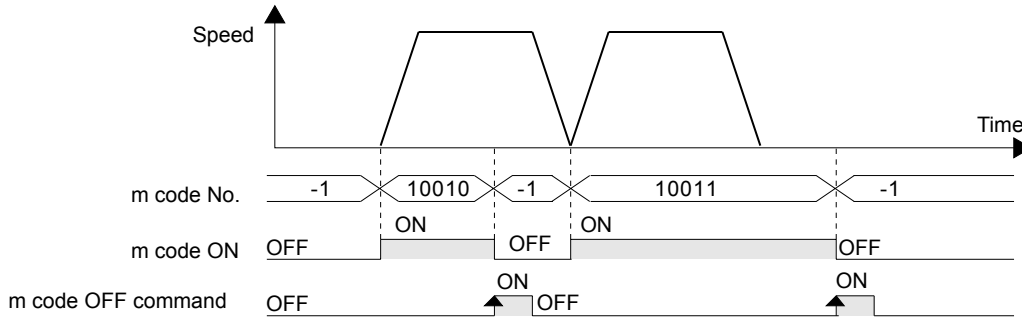

Table No.	Operation information	m code information
0	1 (1-speed positioning)	10010 (with mode)
1	1 (1-speed positioning)	10011 (with mode)
2	0 (END)	-1

- 1) The 20SSC-H stores "10010" in the m code No. of monitor data while also starting table No. 0 with "10010" and turning ON the m code ON flag in the status information.
- 2) At m code OFF, the m code ON flag and m code itself turns OFF, and the 20SSC-H stores "-1" in the m code No. of monitor data.
- 3) The next table No. cannot be executed unless the m code OFF command has been activated.

→ For the parameters, control data and monitor data, refer to Chapter 11

		BFM number		Data type
		X-axis	Y-axis	
m code OFF command	Operation command 1	BFM #518 b11	BFM #618 b11	Control data
m code number		BFM #9	BFM #109	Monitor data
Number of the table in operation		BFM #16	BFM #116	Monitor data
m code ON	Status information	BFM #28 b8	BFM #128 b8	Monitor data

Note

- With a "10000" in the m code information, the 20SSC-H turns to standby mode. With the start command or m code OFF command, the m code turns OFF.
- The 20SSC-H continues operating during multi-speed operation and continuous pass operation without m code OFF commands. The specified m codes also turn ON in consecutive order.

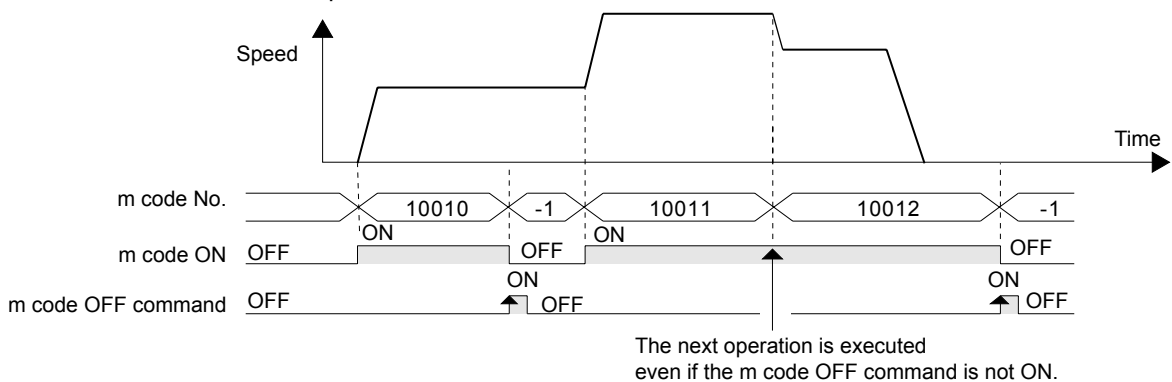

2. Available m code Nos.

To use the m code in the with mode, set the m code in the range from 10000 to 32767.

1 Introduction
2 System configuration
3 Specifications
4 Installation
5 Wiring
6 Memory Config. and data operation
7 Before starting positioning operation
8 Manual control
9 Positioning Control
10 Table Operation

10.10 Continuous Pass Operation

Continuously executing interpolation operation (linear interpolation, circular interpolation) results in a continuous pass operation.

1. Operations valid for continuous pass operation

- Operations that result in continuous pass operation
 - Linear interpolation
 - Circular interpolation
- Operations that do not result in continuous pass operation
 - Variable speed operation
 - Manual pulse generator
 - JOG operation
 - 1-speed positioning operation
 - Interrupt 1-speed constant quantity feed
 - 2-speed positioning operation
 - Interrupt 2-speed constant quantity feed
 - Interrupt stop
 - Multi-speed operation
 - Linear interpolation (interrupt stop)
 - Mechanical zero return
 - Dwell
 - End

Note

- The number of continuous passes is not limited.
- Continuous pass operation continues if interpolation operations include the following:
 - No processing
- Continuous pass operation is not executed if the program contains the following types of instructed interpolation operation:
 - Interpolation operation conditions which disable continuous pass operation
 - a) Interpolation operation in which the m code is set in After mode
 - b) Interpolation operation in which the travel time of the operation is 50 ms or less
 - c) Interpolation operation in which the travel time of the operation is "interpolation time constant × 2" or less
 - System operation when continuous pass operation is disabled

Condition	Operation
Interpolation operation in which the m code is set in After mode	The system waits for the m code OFF command. When the m code OFF command is set to ON, the system operation will transition to the next table.
Interpolation operation in which the travel time of the operation is 50 ms or less	The system does not perform continuous pass operation (in which inflection points make a smooth curve), but the system operation will transition to the next table when positioning is completed. → For details, refer to Subsection 7.11.4
Interpolation operation in which the travel time of the operation is "interpolation time constant × 2" or less	

2. Content of continuous pass operation

- Consecutive interpolation instructions do not stop, and inflection points become smooth curves. The radius of curvature varies depending on the interpolation time constant. A larger interpolation time constant makes a larger radius of curvature.
- To draw a precise locus, apply circular interpolation operations.
- When the speeds between each interpolation operation differ, the velocity becomes a composite speed with the one at the next step.

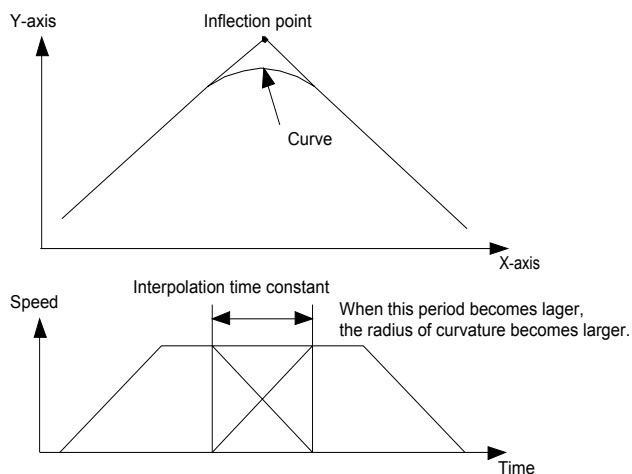
**1**

Introduction

2System
configuration**3**

Specifications

4

Installation

5

Wiring

6Memory Config¹
and data
operation**7**Before starting
positioning
operation**8**

Manual control

9Positioning
Control**10**

Table Operation

11. Buffer Memory (Parameters & Monitored Data)

11.1 Positioning Parameters

The positioning parameters to set speed and units of measurement.
The BFM's in positioning parameters are readable/writable.

→ For the parameter setting method, refer to Section 7.1

For X-axis: BFM #14000 to #14199

For Y-axis: BFM #14200 to #14399

Caution

Do not use unlisted BFM's for changing values not described in this section.

Timing at which positioning parameters are reflected in operations

- When the power is turned ON, positioning parameters stored in the flash memory are transferred to the BFM, and the transferred positioning parameters become valid.
- If positioning parameters are changed in a sequence program, the changed positioning parameters will become valid from the next positioning operation when the positioning parameter enable command (b4 of BFM #519/619) is set to ON from OFF.
 - For details of the positioning parameter enable command, refer to Subsection 11.4.1
 - For the positioning parameter update method, refer to Subsection 7.1.7
- When positioning parameters are set in FX Configurator-FP and written to the 20SSC-H, the written positioning parameters will become valid from the next positioning operation.
 - For setting of parameters, refer to Subsection 7.1.2

11.1.1 Operation parameters 1 [BFM #14000, BFM #14200]

BFM Number		Bit Number	Description	Default
X-axis	Y-axis			
BFM #14000	BFM #14200	b0	System of units (user unit) ^{*1} (b1,b0)=00: motor system (b1,b0)=01: mechanical system (b1,b0)=10: composite system (b1,b0)=11: composite system	H0000
		b1		
		b2	User unit setting ^{*1} (b3,b2)=00: μm, cm/min (b3,b2)=01: 10 ⁻⁴ inch, inch/min (b3,b2)=10: mdeg, 10deg/min (b3,b2)=11: not available	
		b3		
		b4	Position data magnification ^{*2} Position data can be multiplied by 1, 10, 100, and 1000 times. (b5,b4)=00: 1 time (b5,b4)=01: 10 times (b5,b4)=10: 100 times (b5,b4)=11: 1000 times	
		b5		
		b6 to b9	Not available	
		b10	Zero return direction 1: In zero return, starts operation toward the increasing current value direction. 0: In zero return, starts operation toward the decreasing current value direction. →For details on the zero return operation, refer to Section 8.1	
b11	Acceleration/deceleration mode 1: Operates in approximate S-shaped acceleration/deceleration. (Trapezoidal ACC/DEC in interpolations) 0: Operates in trapezoidal acceleration/deceleration. →For details on the acceleration/deceleration mode, refer to Section 7.2			

BFM Number		Bit Number	Description	Default
X-axis	Y-axis			
BFM #14000	BFM #14200	b12	DOG switch input logic Sets DOG switch input logic for 20SSC-H. 1: NC-contact (operates at input OFF) 0: NO-contact (operates at input ON) →For details on the DOG mechanical zero return operation, refer to Subsection 8.1.2	H0000
		b13	Count start timing for zero-phase signal 1: DOG forward end (at OFF-to-ON transition of DOG input) The front end of DOG triggers the zero-phase signal count. 0: DOG backward end (at ON-to-OFF transition of DOG input) The back end of DOG triggers the zero-point signal count. →For details on the DOG mechanical zero return operation, refer to Subsection 8.1.2	
		b14	Not available	
		b15	STOP mode 1: Suspends the operation, and the START command starts the operation for the remaining travel distance. 0: Ends the operation, canceling the remaining distance. In table operations, operation is terminated. →For details on the stop command, refer to Section 7.4	

*1. User unit setting

Positioning and speed units are customizable as user units.

The combination of the system of units (b1,b0) and unit setting bits (b3,b2) give the following settings.

→ For details on the user units, refer to Section 7.10

Unit Setting Bit Status		System of units Bit Status		System of units	Unit	
b3	b2	b1	b0		Positioning Unit	Speed Unit
-	-	0	0	Motor system units	PLS	Hz
0	0	0	1	Mechanical system units	μm	cm/min
0	1	0	1		10 ⁻⁴ inch	inch/min
1	0	0	1		mdeg	10deg/min
0	0	1	0/1	Composite system units	μm	Hz
0	1	1	0/1		10 ⁻⁴ inch	
1	0	1	0/1		mdeg	

Note

Motor system units and mechanical system units require pulse/feed rate settings.

*2. The positioning data with position data magnification are as follows:

- Mechanical zero-point address
- Software limit (upper)
- Software limit (lower)
- Target address1
- Target address2
- Target position change value (address)
- Current address (user)
- Current address (pulse)
- Table information (position data)
- Table information (circular data)

Example:

The actual address (or travel distance) with target address 1 "123" and position data magnification "1000" are as follows:

Motor system units: $123 \times 1000 = 123000$ (pulse)

Mechanical system units, composite system units: $123 \times 1000 = 123000$ (μm, mdeg, 10⁻⁴inch)
= 123 (mm, deg, 10⁻¹inch)

11.1.2 Operation parameters 2 [BFM #14002, BFM #14202]

BFM Number		Bit Number	Description	Default
X-axis	Y-axis			
BFM #14002	BFM #14202	b0	<p>Enables or disables the servo end check function. → For details on the servo end check, refer to Subsection 7.9.2</p> <p>1: Enable At an in-position signal, is determined the positioning operation completion 0: Disable</p>	H0007
		b1	<p>Enables or disables the servo ready check function. → For details on the servo ready check, refer to Subsection 7.9.1</p> <p>1: Enable Checks the ready signal ON/OFF at operation start / while operation 0: Disable</p>	
		b2	<p>Enables or disables the OPR interlock function. → For details on the OPR interlock, refer to Subsection 7.9.10</p> <p>1: Enable Disables the START command without zero return completion Enables the START command with zero return completion (zero return completed: ON) 0: Disable</p>	
		b3	<p>Enables or disables the ring counter setting. (Ver.1.10 or later) → For details on the ring counter setting, refer to Section 7.8</p> <p>1: Enables the ring operation. 0: Disables the ring operation.</p>	
		b4	<p>Set the stop method when the Stop command turns ON (Ver.1.20 or later) → For details on sudden stop / Normal deceleration stop, refer to Section 7.5</p> <p>1: Sudden stop 0: Normal deceleration stop</p>	
		b5	<p>Set the stop method when the software limit turns ON (Ver.1.20 or later) → For details on sudden stop / Normal deceleration stop, refer to Section 7.5</p> <p>1: Sudden stop 0: Normal deceleration stop</p>	
		b6	<p>Set the stop method when the PLC limit turns ON (Ver.1.20 or later) → For details on sudden stop / Normal deceleration stop, refer to Section 7.5</p> <p>1: Sudden stop 0: Normal deceleration stop</p>	
		b7	<p>Set the stop method when the Servo amplifier stroke limit turns ON (Ver.1.20 or later) → For details on sudden stop / Normal deceleration stop, refer to Section 7.5</p> <p>1: Sudden stop 0: Normal deceleration stop</p>	
		b8	<p>Set the servo ON/OFF status to be selected when the servo amplifier is started up (in Ver. 1.30 or later). 1: Servo OFF*¹ The servo OFF status is selected when the servo amplifier is started up. It is necessary to specify the servo ON status in a sequence program. → For details of the servo ON/OFF status selection at startup, refer to Subsection 7.9.6 0: Servo ON The servo ON status is automatically selected when the servo amplifier is started up. (The servo amplifier operates in the same way as versions earlier than Ver. 1.30.)</p>	
b9 to b13	Not available			

BFM Number		Bit Number	Description	Default
X-axis	Y-axis			
BFM #14002	BFM #14202	b14 ^{*2}	Sets the interpolation gear ratio selection (Ver.1.20 or later) → For details on interpolation gear ratio selection, refer to Subsection 7.11.3 1: X-axis, Y-axis 0: X-axis	H0007
		b15	Set the servo parameters transfer source when the servo amplifier series is selected. (Ver.1.10 or later) → For details on servo parameter transfer, refer to Subsection 6.2.3 and Section 7.1 1: Transfers data stored in the buffer memory to the servo amplifier. 0: Transfers data stored in the flash memory to the servo amplifier.	

- *1. If started up with the "servo OFF" setting, specify the servo ON status using the following procedure.
→ **For details, refer to Subsection 7.9.6**
- 1) Confirm that "unit ready" in the status information is ON.
 - 2) Confirm that "ready ON" in the servo status is ON.
 - 3) Set the servo OFF command to OFF to set the servo amplifier to the servo ON status.
When the servo amplifier switches to the servo ON status, "servo ON" in the servo status turns ON.
- *2. BFM # 14202 (b14) is not available.

11.1.3 Pulse rate [BFM #14005, #14004, BFM #14205, #14204]

This parameter sets the number of pulses to rotate the servo motors once. "Mechanical system units" and "Composite system units" require this setting, "Motor system units" ignores it.

→ **For details on the system of units, refer to Section 7.10**

BFM Number		Description	Default
X-axis	Y-axis		
BFM #14005, #14004	BFM #14205, #14204	Setting range: 1 to 200,000,000 PLS/REV	K262,144

11.1.4 Feed rate [BFM #14007, #14006, BFM #14207, #14206]

This parameter sets the travel distance per revolution of the motor. "Mechanical system units" and "Composite system units" require this setting, "Motor system units" ignores it.

→ **For details on the system of units, refer to Section 7.10**

BFM Number		Description	Default
X-axis	Y-axis		
BFM #14007, #14006	BFM #14207, #14206	Setting range: 1 to 200,000,000 ($\mu\text{m}/\text{REV}$, $10^{-4}\text{inch}/\text{REV}$, mdeg/REV)	K52,428,800

11

Buffer Memory

12

Program Example

13

Diagnostics

A

List of Parameters and Data

B

Version Information

11.1.5 Maximum speed [BFM #14009, #14008, BFM #14209, #14208]

This parameter sets the maximum speed for each operation.

→ For details on the maximum speed, refer to Section 7.2

BFM Number		Description	Default
X-axis	Y-axis		
BFM #14009, #14008	BFM #14209, #14208	Setting range: 1 to 2,147,483,647(user unit) ^{*1} The value must be within the range from 1 to 50,000,000 Hz when converted to pulse data ^{*1} .	K4,000,000

*1. Refer to the section shown below for details on the user units and converted pulse data.

→ Refer to Section 7.10

Note

Set JOG speed, zero return speed (high speed), zero return speed (creep), operation speed 1 and operation speed 2 at or below the maximum speed. If the operation speed exceeds the maximum speed, the 20SSC-H operates at the maximum speed.

Cautions in setting

Set the maximum speed at or below the maximum rotation speed of the servo motor.

The formula to calculate the rotation speed of the servo motor from the pulse (Converted pulse data) is as follows.

→ For details on the converted pulse data, refer to Section 7.10

Servo motor rotational speed (r/min) =

Operation speed converted into pulse (Hz) × 60 ÷ resolution per revolution of servo motor

Servo Amplifier	Resolution per Revolution of Servo Motor (PLS/REV)
MR-J3-□B,MR-J3W-□B,MR-J3-□BS,MR-J4(W2)-□B(J3 compatibility mode)	262,144

11.1.6 JOG speed [BFM #14013, #14012, BFM #14213, #14212]

This parameter sets the speed for Forward JOG and Reverse JOG operations.

→ For details on the JOG operations, refer to Section 8.2

BFM Number		Description	Default
X-axis	Y-axis		
BFM #14013, #14012	BFM #14213, #14212	Setting range: 1 to 2,147,483,647 (user unit) ^{*1} Set the value within 1 to 50,000,000Hz in converted pulse data ^{*1} .	K2,000,000

*1. Refer to the section shown below for details on the user units and converted pulse data.

→ Refer to Section 7.10

Note

- Set the JOG speed at or below the maximum speed.
When the JOG speed exceeds the maximum speed, the 20SSC-H operates at the maximum speed.
- Speed change commands in positioning operation change the JOG speed into a preset value.

11.1.7 JOG Instruction evaluation time [BFM #14014, BFM #14214]

This parameter sets the evaluation time for the forward/reverse JOG command to determine whether the control is inching or continuous.

For forward/reverse commands that are ON for longer than the JOG evaluation time, the 20SSC-H executes continuous operation. For forward/reverse commands that are ON for shorter than the JOG evaluation time, the 20SSC-H executes inching operation.

→ For details on the JOG operations, refer to Section 8.2

BFM Number		Description	Default
X-axis	Y-axis		
BFM #14014	BFM #14214	Setting range: 0 to 5000 ms	K300

POINT

The JOG instruction evaluation time "0 ms" gives continuous operation only.

11.1.8 Acceleration time [BFM #14018, BFM #14218]

This parameter sets a time for the operation speed to reach the maximum speed from zero. In a 20SSC-H Ver. 1.30 or later, "acceleration time" and "acceleration time 2" are offered as the acceleration time except for interpolation operation. Use the acceleration/deceleration time change command in operation command 2 to select acceleration time or acceleration time 2 to be used for actual positioning operation.

→ For details on the acceleration time, refer to Section 7.2

→ For setting of the acceleration time 2, refer to Subsection 11.1.25

→ For changeover of the acceleration/deceleration time, refer to Section 7.7

BFM Number		Description	Default
X-axis	Y-axis		
BFM #14018	BFM #14218	Setting range: 1 to 5000 ms	K200

Note

- The acceleration time becomes 1 ms when set at 0 ms or less, and becomes 5000 ms when set at 5001 ms or more.
- Set the time within the range from 64 (greater than 64) to 5000 ms in the approximate S-shaped acceleration/deceleration.

11.1.9 Deceleration time [BFM #14020, BFM #14220]

This parameter sets the time for the operation speed to reach zero from the maximum.

In a 20SSC-H Ver. 1.30 or later, "deceleration time" and "deceleration time 2" are offered as the acceleration time except for interpolation operation. Use the acceleration/deceleration time change command in operation command 2 to select deceleration time or deceleration time 2 to be used for actual positioning operation.

→ For details on the deceleration time, refer to Section 7.2

→ For setting of the deceleration time 2, refer to Subsection 11.1.26

→ For changeover of the acceleration/deceleration time, refer to Section 7.7

BFM Number		Description	Default
X-axis	Y-axis		
BFM #14020	BFM #14220	Setting range: 1 to 5000 ms	K200

Note

- The acceleration time becomes 1 ms when set at 0 ms or less, and becomes 5000 ms when set at 5001 ms or more.
- Set the time within the range from 64 (greater than 64) to 5000 ms in the approximate S-shaped acceleration/deceleration.

11.1.10 Interpolation time constant [BFM #14022, BFM #14222]

This parameter sets the time to reach the operation speed from zero (acceleration) or to reach zero from the operation speed (deceleration).

→ For details on the interpolation time constant, refer to Section 7.2

BFM Number		Description	Default
X-axis	Y-axis		
BFM #14022	BFM #14222	Setting range: 1 to 5000 ms	K100

Note

The acceleration time becomes 1 ms when set at 0 ms or less, and becomes 5000 ms when set at 5001 ms or more.

11.1.11 Zero return speed (High Speed) [BFM #14025, #14024, BFM #14225, #14224]

This parameter sets the mechanical zero return operation speed (high speed) [DOG, Stopper #1].

→ For details on the mechanical zero return, refer to Section 8.1

BFM Number		Description	Default
X-axis	Y-axis		
BFM #14025, #14024	BFM #14225, #14224	Setting range: 1 to 2,147,483,647 (user unit) ^{*1} Set the value within 1 to 50,000,000Hz in converted pulse data ^{*1} .	K4,000,000

*1. Refer to the section shown below for details on the user units and converted pulse data.

→ Refer to Section 7.10

Note

- Set the zero return speed (high speed) at or below the maximum speed.
When the zero return speed (high speed) exceeds the maximum speed, the 20SSC-H operates at the maximum speed.
- Speed change commands in positioning operation change the zero return speed (high speed) into a preset value.

11.1.12 Zero return speed (Creep) [BFM #14027, #14026, BFM #14227, #14226]

This parameter sets the mechanical zero return operation speed (creep) [DOG, Stopper #1, #2].

→ For details on the mechanical zero return, refer to Section 8.1

BFM Number		Description	Default
X-axis	Y-axis		
BFM #14027, #14026	BFM #14227, #14226	Setting range: 1 to 2,147,483,647 (user unit) ^{*1} Set the value within 1 to 50,000,000Hz in converted pulse data ^{*1} .	K100,000

*1. Refer to the section shown below for details on the user units and converted pulse data.

→ Refer to Section 7.10

Note

- Set the zero return speed (creep) at or below the maximum speed and zero return speed (high speed).
When the zero return speed (creep) exceeds the maximum speed, the 20SSC-H operates at the maximum speed.
- Set the speed as slow as possible to achieve the best stop position accuracy.

11.1.13 Mechanical zero-point address [BFM #14029, #14028, BFM #14229, #14228]

This parameter sets the current value address at zero return operation completion.

After mechanical zero return completion, the 20SSC-H writes the current address to this parameter.

→ For details on the mechanical zero return, refer to Section 8.1

BFM Number		Description	Default
X-axis	Y-axis		
BFM #14029, #14028	BFM #14229, #14228	Setting range ^{*1} : -2,147,483,648 to 2,147,483,647 (user unit) ^{*2} Set the value within -2,147,483,648 to 2,147,483,647PLS in converted pulse data ^{*2}	K0

*1. Set a value within the range from 0 to the ring value during the ring operation.

*2. Refer to the section shown below for details on the user units and converted pulse data.

→ Refer to Section 7.10

11.1.14 Zero-phase signal count [BFM #14030, BFM #14230]

This parameter sets the number of zero-phase signal counts in the mechanical zero return operation (DOG type).

The mechanical zero return ends at the specified number of zero-phase signal count.

→ For details on the mechanical zero return, refer to Section 8.1

BFM Number		Description	Default
X-axis	Y-axis		
BFM #14030	BFM #14230	Setting range: 0 to 32767 PLS	K1

Note

- With the value "0" set in mechanical zero return operation [DOG], the 20SSC-H immediately stops when the zero-phase signal count starts. In this case, the operation abruptly stops from the zero return speed (creep/high speed). Observe the following items to protect peripheral devices from damage.
 - Set the zero return speed (creep) as slow as possible for safety.
 - Change the trigger of the zero-point signal count at the DOG backward end.
 - Design the DOG to allow the machine to gently decelerate to the zero return speed (creep) before the zero-phase signal count.

11.1.15 Zero return mode [BFM #14031, BFM #14231]

This parameter selects mechanical zero return operations.

→ For details on the zero return operation, refer to Section 8.1

BFM Number		Description	Default
X-axis	Y-axis		
BFM #14031	BFM #14231	0: DOG 1: Data set type 2: Stopper #1 3: Stopper #2	K0

11.1.16 Servo end evaluation time [BFM #14032, BFM #14232]

This parameter sets the evaluation time for the servo end check.

→ For details on the servo end check, refer to Subsection 7.9.2

BFM Number		Description	Default
X-axis	Y-axis		
BFM #14032	BFM #14232	Setting range: 1 to 5000 ms	K5000

Note

- To apply this function, set b0 in the operation parameter 2 to ON.
 - For details on the operation parameters 2, refer to Subsection 11.1.2
- For a servo end evaluation time setting outside of the range, see the following:
 - Becomes 1 ms when set at 0 ms or less.
 - Becomes 5000 ms when set at 5001 ms or more.

11.1.17 Software limit (upper) [BFM #14035, #14034, BFM #14235, #14234] Software limit (lower) [BFM #14037, #14036, BFM #14237, #14236]

This parameter sets each address value for the software limit.

The software limit is an operating limit from the current address after zero return operation completion, which becomes enabled upon completion of the zero return operation.

→ For details on the software limit, refer to Subsection 7.3.3

BFM Number		Description	Default
X-axis	Y-axis		
BFM #14035, #14034	BFM #14235, #14234	Sets the software limit (upper) Setting range: -2,147,483,648 to 2,147,483,647 (user unit) ^{*1} Set the value within -2,147,483,648 to 2,147,483,647PLS in the converted pulse data ^{*1} .	K0
BFM #14037, #14036	BFM #14237, #14236	Sets the software limit (lower) Setting range: -2,147,483,648 to 2,147,483,647 (user unit) ^{*1} Set the value within -2,147,483,648 to 2,147,483,647PLS in the converted pulse data ^{*1} .	K0

*1. Refer to the section shown below for details on the user units and converted pulse data.

→ Refer to Section 7.10

POINT

The relationship between the upper and lower software limits must be as follows:

- When enabling the software limit
Software limit (upper) is larger than Software limit (lower)
- When disabling the software limit
Software limit (upper) is equal to Software limit (lower)
Software limit (upper) is smaller than Software limit (lower)

11.1.18 Torque limit value [BFM #14038, BFM #14238]

This parameter sets the torque limit for the servo motor and magnifies the servo motor torque in the range from 0.1 to 1000.0%. For a target move with a torque limit, refer to the section shown below.

→ For details on the torque limit function, refer to Subsection 7.9.3

BFM Number		Description	Default
X-axis	Y-axis		
BFM #14038	BFM #14238	Setting range: 1 to 10000 (× 0.1%)	K3000

11.1.19 Zero return torque limit [BFM #14040, BFM #14240]

This parameter sets the torque limit value (torque generated by the servo motor) for mechanical zero return at the zero return speed (creep) in the range from 0.1 to 1000.0%.

The torque limit at the zero return speed (high speed) is determined by the torque limit value or torque output set value.

→ For details on the torque limit function, refer to Subsection 7.9.3

BFM Number		Description	Default
X-axis	Y-axis		
BFM #14040	BFM #14240	Setting range: 1 to 10000 (× 0.1%)	K3000

11.1.20 External input selection [BFM #14044, BFM #14244]

BFM Number		Bit Number	Description	Default
X-axis	Y-axis			
BFM #14044	BFM #14244	b0	Sets the FLS, RLS signals from the servo amplifier to be used/not used →For instructions on how to use forward/reverse rotation limit, refer to Section 7.3 1: Use Use forward/reverse rotation limits from the servo amplifier and those from the PLC. 0: Not use Use only forward/reverse rotation limits from the PLC.	H0100
		b1	Sets the DOG signals from the servo amplifier to be used/not used →For details on the mechanical zero return, refer to Section 8.1 1: Use Use DOG signals from the servo amplifier. 0: Not use Use DOG signals from the 20SSC-H. The "b12" in command parameter1 sets the 20SSC-H DOG signal. →For details on the operation parameters 1, refer to Subsection 11.1.1	
		b2 to b7	Not available	
		b8	Sets the FLS/RLS signal logic of the servo motor 1: NC-contact (servo amplifier) 0: NO-contact (servo amplifier)	
		b9	Sets the DOG signal logic of the servo motor 1: NC-contact (servo amplifier) 0: NO-contact (servo amplifier)	
		b10 to b15	Not available	

11.1.21 Ring counter upper limit value [BFM #14101, #14100, BFM #14301, #14300]

Sets the ring value to enable ring operation for the current address. (Ver.1.10 or later)

BFM Number		Description	Default
X-axis	Y-axis		
BFM #14101, #14100	BFM #14301, #14300	Setting range : 1 to 359,999,999 (user unit)*1 Set the value within 1 to 359,999,999 PLS in the converted pulse data*1.	K359,999

*1. For details on the user units, refer to the following.

→ Refer to Section 7.10

11.1.22 Sudden stop deceleration time [BFM #14102, BFM #14302]

Set the time to reach 0 speed from the maximum speed at sudden stop. (Ver.1.20 or later)

→ For details on the sudden stop deceleration time, refer to Section 7.5

BFM Number		Description	Default
X-axis	Y-axis		
BFM #14102	BFM #14302	Setting range: 1 to 5000 ms	K200

POINT

- The sudden stop deceleration time becomes 1 ms when set at 0 ms or less, and becomes 5000 ms when set at 5001 ms or more.

11.1.23 Sudden stop interpolation time constant [BFM #14104, BFM #14304]

Set the time to reach 0 speed from the operation speed at sudden stop (interpolation operation).
(Ver.1.20 or later)

→ For details on the sudden stop interpolation time constant, refer to Section 7.5

BFM Number		Description	Default
X-axis	Y-axis		
BFM #14104	BFM #14304	Setting range: 1 to 5000 ms	K100

POINT

- The sudden stop interpolation time constant becomes 1 ms when set at 0 ms or less, and becomes 5000 ms when set at 5001 ms or more.

11.1.24 Positioning completion signal output waiting time [BFM #14106, BFM #14306]

Set the time after positioning is completed until the positioning completion flag turns ON. (Ver.1.20 or later)

→ For details on the positioning completion signal output waiting time, refer to Subsection 7.9.11

BFM Number		Description	Default
X-axis	Y-axis		
BFM #14106	BFM #14306	Setting range: 0 to 5000 ms	K0

POINT

- When the positioning operation time is shorter than a PLC scan, the sequence program can only detect the positioning completion signal if the positioning completion signal output waiting time is set to a time longer than the scan time.
- Becomes 5000 ms when set at 5001 ms or more.
- If positioning is completed and an error occurs during the positioning completion signal output waiting time, the positioning completion signal remains OFF.
- The setting of the positioning completion signal output waiting time is invalid during table operation.

11.1.25 Acceleration time 2 [BFM #14108, BFM #14308]

This parameter sets the time for the operation speed to reach the maximum speed from zero.

The acceleration time except in interpolation operation consists of two types, "acceleration time" and "acceleration time 2." Use the acceleration/deceleration time change command in operation command 2 to select which type should be used for actual positioning operation (Ver. 1.30 or later).

→ For the acceleration time, refer to Section 7.2

→ For setting of the acceleration time, refer to Subsection 11.1.8

→ For changeover of the acceleration/deceleration time, refer to Section 7.7

BFM Number		Description	Default
X-axis	Y-axis		
BFM #14108	BFM #14308	Setting range: 1 to 5000 ms	K200

Note

- The acceleration time becomes 1 ms when set at 0 ms or less, and becomes 5000 ms when set at 5001 ms or more.
- Set the time within the range from 64 (greater than 64) to 5000 ms in approximate S-shaped acceleration/deceleration.

11.1.26 Deceleration time 2 [BFM #14110, BFM #14310]

This parameter sets the time for the operation speed to reach zero from the maximum speed.

The deceleration time except in sudden stop and interpolation operation consists of two types, "deceleration time" and "deceleration time 2."

Use the acceleration/deceleration time change command in operation command 2 to select which type should be used for actual positioning operation (Ver. 1.30 or later).

→ For the deceleration time, refer to Section 7.2

→ For setting of the deceleration time, refer to Subsection 11.1.9

→ For changeover of the acceleration/deceleration time, refer to Section 7.7

BFM Number		Description	Default
X-axis	Y-axis		
BFM #14110	BFM #14310	Setting range: 1 to 5000 ms	K200

Note

- The set value smaller than "0 ms" is handled as "1 ms", and the set value larger than "5001 ms" is handled as "5000 ms."
- When using approximate S-shaped acceleration/deceleration, set a value within the range from 64 to 5000 ms (not less than 64 ms).

11

Buffer Memory

12

Program Example

13

Diagnostics

A

List of Parameters and Data

B

Version Information

11.2 Servo Parameters

Various parameters for the servo amplifier can be set. The following buffer memories in the servo parameters are readable and writable.

For details on the servo amplifier parameters in the table below with their parameter numbers, refer to the manual of the servo amplifier.

→ **For details of servo parameters, refer to the manual of the connected servo amplifier**

For X-axis: BFM #15000 to #15199

For Y-axis: BFM #15200 to #15399

CAUTION

- Do not use unlisted BFM's for changing values not described in this section.
- The MR-J3W-□B can be used within the functional range of the MR-J3-□B.
→ **For caution on setting parameter of the MR-J3W-□B, refer to Section 7.1**
- The MR-J3-□BS can be used within the functional range of the semi closed loop system.
→ **For caution on setting parameter of the MR-J3-□BS, refer to Section 7.1**
- The MR-J4(W2)-□B can be used within the functional range of the "J3 compatibility mode".
→ **For caution on setting parameter of the MR-J4(W2)-□B, refer to Section 7.1**

Timing at which servo parameters are reflected in operations

When servo parameters are transferred to the connected servo amplifier, they will become valid from the next positioning operation.

→ **For the transfer timing of servo parameters to the servo amplifier, refer to Subsection 6.2.3**

- Set or change servo parameters, and transfer them to the servo amplifier. It is necessary to turn OFF the power once and then turn it ON again or a perform system reset to transfer servo parameters to the servo amplifier.
→ **For the parameter setting method, refer to Section 7.1**
- The following servo parameters stored in the buffer memory are transferred to the servo amplifier when the servo parameter transfer command (X-axis: b9 of BFM #519, Y-axis: b9 of BFM #619) is set to ON from OFF. Transferred servo parameters will become valid from the next positioning operation.
→ **For the transfer method, refer to Subsection 7.1.8**
 - Auto tuning mode
 - Ratio of load inertia moment to servo motor inertia moment
 - Speed control gain
 - Auto tuning response
 - Model control gain
 - Speed integral compensation
 - Feed forward gain
 - Position control gain
 - Speed differential compensation

11.2.1 Servo parameters (Basic settings)

BFM Number		Servo Amplifier Parameter No.	Name	Description	Default
X-axis	Y-axis				
BFM #15000	BFM #15200	-	Servo series	Specify the series name of the servo amplifier connected to the 20SSC-H. 0: None 1: MR-J3-B ^{*1} 3: MR-J3-BS ^{*2} CAUTION The servo series name must be specified. 20SSC-H at factory default value "0" does not communicate with servo amplifiers.	K0

*1. When connecting the MR-J3W-□B, set "1: MR-J3-B" as the servo series.

*2. The MR-J3-BS can be set for 20SSC-H blocks Ver.1.40 or later.
When connecting the MR-J4W2-□B, set "3: MR-J3-BS" as the servo series.

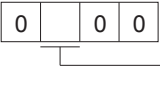
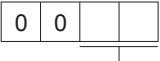
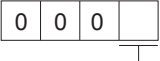
BFM Number		Servo Amplifier Parameter No.	Name	Description	Default															
X-axis	Y-axis																			
BFM #15001	BFM #15201	PA01	Control mode (Ver.1.40 or later)	Select the control loop composition.  Control type selection <table border="1"> <thead> <tr> <th>Setting value</th> <th>Control loop composition</th> <th>350% maximum torque setting of HF-KP servo motor</th> </tr> </thead> <tbody> <tr> <td>0</td> <td>Standard control</td> <td>Invalid</td> </tr> <tr> <td>3</td> <td>Standard control</td> <td>Valid</td> </tr> <tr> <td>4</td> <td>High-response control</td> <td>Invalid</td> </tr> <tr> <td>5</td> <td>High-response control</td> <td>Valid</td> </tr> </tbody> </table>	Setting value	Control loop composition	350% maximum torque setting of HF-KP servo motor	0	Standard control	Invalid	3	Standard control	Valid	4	High-response control	Invalid	5	High-response control	Valid	H0000
Setting value	Control loop composition	350% maximum torque setting of HF-KP servo motor																		
0	Standard control	Invalid																		
3	Standard control	Valid																		
4	High-response control	Invalid																		
5	High-response control	Valid																		
BFM #15002	BFM #15202	PA02*1	Regenerative brake option	Select which regenerative brake option to use, or not use.  Revival option selection 00: Regenerative brake resistor not used - For servo amplifier of 100W, regenerative resistor is not used. - For servo amplifier of 200 to 7kW, built-in regenerative resistor is used. - Supplied regenerative resistors or regenerative option is used with the servo amplifier of 11k to 22kW. - For a drive unit of 30kW or more, select regenerative option by the converter unit. 01: FR-BU / FR-RC 02: MR-RB032 03: MR-RB12 04: MR-RB32 05: MR-RB30 06: MR-RB50(Cooling fan is required) 08: MR-RB31 09: MR-RB51(Cooling fan is required) 80: MR-RB1H-4 81: MR-RB3M-4(Cooling fan is required) 82: MR-RB3G-4(Cooling fan is required) 83: MR-RB5G-4(Cooling fan is required) 84: MR-RB34-4(Cooling fan is required) 85: MR-RB54-4(Cooling fan is required) FA: When the supplied regenerative resistor is cooled by the cooling fan to increase performance with a servo amplifier of 11k to 22kW.	H0000															
BFM #15003	BFM #15203	PA03	Absolute position detection system	Select whether or not to use the absolute position detection system.  Absolute position detection system setting 0: Disable (use in incremental system) 1: Enable (use in absolute position detection system)	H0000															

*1. When using MR-J3W-□B or MR-J4W2-□B, both axes should have the same setup. (X-axis, Y-axis)

11 Buffer Memory

12 Program Example

13 Diagnostics

A List of Parameters and

B Version Information

*2. Servo forced stop selection

Setting value	EM1/EM2 selection	Deceleration method when EM1 or EM2 becomes valid	Deceleration method when an alarm occurs
00	Forced stop 2 (EM2)	The electromagnetic brake interlock (MBR) turns off after the forced stop deceleration.	The electromagnetic brake interlock (MBR) turns off after the forced stop deceleration.
10	Forced stop 2 (EM2)	The electromagnetic brake interlock (MBR) turns off simultaneously with the start of the forced stop deceleration.	The electromagnetic brake interlock (MBR) turns off simultaneously with the start of the forced stop deceleration.
30	Forced stop 1 (EM1)	The electromagnetic brake interlock (MBR) turns off without the forced stop deceleration.	The electromagnetic brake interlock (MBR) turns off without the forced stop deceleration.
01	Not using EM1 or EM2	-	The electromagnetic brake interlock (MBR) turns off after the forced stop deceleration.
11		-	The electromagnetic brake interlock (MBR) turns off simultaneously with the start of the forced stop deceleration.
31		-	The electromagnetic brake interlock (MBR) turns off without the forced stop deceleration.

*3. Foced stop and forced stop deceleration function selection

Setting value	EM2/EM1 selection	Deceleration method	
		EM2 or EM1 is off	Alarm occurred
00	EM1	The electromagnetic brake interlock (MBR) turns off without the forced stop deceleration.	The electromagnetic brake interlock (MBR) turns off without the forced stop deceleration.
20	EM2	The electromagnetic brake interlock (MBR) turns off after the forced stop deceleration.	The electromagnetic brake interlock (MBR) turns off after the forced stop deceleration.
01	Not using EM2 or EM1	-	The electromagnetic brake interlock (MBR) turns off without the forced stop deceleration.
21	Not using EM2 or EM1	-	The electromagnetic brake interlock (MBR) turns off after the forced stop deceleration.

11.2.2 Servo parameters (Gain/Filter settings)

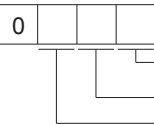
BFM Number		Servo Amplifier Parameter No.	Name	Description	Default
X-axis	Y-axis				
BFM #15019	BFM #15219	PB01	Adaptive tuning mode (Adaptive filter 2)	Select the adaptive filter tuning mode. 0: Filter OFF 1: Filter tuning mode (adaptive filter) 2: Manual mode	K0
BFM #15020	BFM #15220	PB02	Vibration suppression control tuning mode (advanced vibration suppression control)	Select the vibration suppression control tuning mode. 0: Vibration suppression control OFF 1: Vibration suppression control tuning mode 2: Manual mode	K0
BFM #15022	BFM #15222	PB04	Feed forward gain	Set the feed forward gain coefficient to be used for positioning control. Setting range: 0 to 100%	K0
BFM #15024	BFM #15224	PB06	Ratio of load inertia moment to servo motor inertia moment	Set the ratio of load inertia moment to servo motor inertia moment. Setting range: 0 to 3000 ($\times 0.1$ times)	K70
BFM #15025	BFM #15225	PB07	Model loop gain	Set the response gain up to the target position. Setting range: 1 to 2000 rad/s	K24
BFM #15026	BFM #15226	PB08	Position loop gain	Set the gain of the position loop. Setting range: 1 to 1000 rad/s	K37
BFM #15027	BFM #15227	PB09	Speed loop gain	Set the gain of the speed loop. Setting range: 20 to 50000 rad/s	K823
BFM #15028	BFM #15228	PB10	Speed integral compensation	Set the integral time constant of the speed loop. Setting range: 1 to 10000 ($\times 0.1$ ms)	K337
BFM #15029	BFM #15229	PB11	Speed differential compensation	Set the differential compensation. Setting range: 0 to 1000	K980
BFM #15030	BFM #15230	PB12	Overshoot amount compensation (Ver.1.40 or later)	Set the control ratio against the friction torque. Setting range: 0 to 100%	K0
BFM #15031	BFM #15231	PB13	Machine resonance suppression filter 1	Set the notch frequency of the machine resonance suppression filter 1. (Set the frequency in accordance with the mechanical resonance frequency.) Setting range: 100 to 4500 Hz	K4500
BFM #15032	BFM #15232	PB14	Notch shape selection 1	Specify the notch shape used for the machine resonance suppression filter 1 (Notch shape selection 1).  • Notch Depth Notch Width 0: Deep (-40db) 0: Standard ($\alpha=2$) 1: \uparrow (-14db) 1: \uparrow ($\alpha=3$) 2: \downarrow (-8db) 2: \downarrow ($\alpha=4$) 3: Shallow (-4db) 3: Wide ($\alpha=5$)	H0000
BFM #15033	BFM #15233	PB15	Machine resonance suppression filter 2	Set the notch frequency of the machine resonance suppression filter 2. (Set the frequency in accordance with the mechanical resonance frequency.) Setting range: 100 to 4500 Hz	K4500
BFM #15034	BFM #15234	PB16	Notch shape selection 2	Specify the notch shape used for the machine resonance suppression filter 2 (Notch shape selection 2).  • Select the machine resonance suppression filter 2 0: Disable 1: Enable • Notch Depth Notch Width 0: Deep (-40db) 0: Standard ($\alpha=2$) 1: \uparrow (-14db) 1: \uparrow ($\alpha=3$) 2: \downarrow (-8db) 2: \downarrow ($\alpha=4$) 3: Shallow (-4db) 3: Wide ($\alpha=5$)	H0000

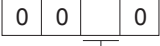
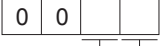
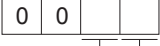
BFM Number		Servo Amplifier Parameter No.	Name	Description	Default
X-axis	Y-axis				
BFM #15036	BFM #15236	PB18	Low pass filter setting	Set the low pass filter. Setting range: 100 to 18000 rad/s	K3141
BFM #15037	BFM #15237	PB19	Vibration suppression control vibration frequency setting	Set the vibration frequency for vibration suppression control to suppress low-frequency machine vibration, such as enclosure vibration. Setting range: 1 to 1000 ($\times 0.1$ Hz)	K1000
BFM #15038	BFM #15238	PB20	Vibration suppression control resonance frequency setting	Set the resonance frequency for vibration suppression control to suppress low-frequency machine vibration, such as enclosure vibration. Setting range: 1 to 1000 ($\times 0.1$ Hz)	K1000
BFM #15041	BFM #15241	PB23	Low pass filter selection	Select the procedure to set the low pass filter.  0: Automatic setting 1: Manual setting (specify a number for the low pass filter setting)	H0000
BFM #15042	BFM #15242	PB24	Slight vibration suppression control selection	Select the slight vibration suppression control.  <ul style="list-style-type: none"> Slight vibration suppression control selection 0: Disable 1: Enable PI-PID switch over selection 0: Enables PI control 3: Enables PID control all the time 	H0000
BFM #15044	BFM #15244	PB26	Gain changing selection	Select the gain changing selections/conditions.  <ul style="list-style-type: none"> Gain changing selection 0: Disable 1: Settings designated by a gain change command take effect 2: Set command frequency as a trigger to change gain 3: Set droop pulses as a trigger to change gain 4: Set servo motor speed as a trigger to change gain Gain changing condition 0: Valid when a value is bigger than the set value 1: Valid when a value is smaller than the set value 	H0000
BFM #15045	BFM #15245	PB27	Gain changing condition	Set the value for gain changing condition. Setting range: 0 to 9999 (kpps, PLS, r/min)	K10
BFM #15046	BFM #15246	PB28	Gain changing time constant	Set the time constant for changing gain. Setting range: 0 to 100 ms	K1
BFM #15047	BFM #15247	PB29	Gain changing Ratio of load inertia moment to servo motor inertia moment	Set the ratio of load inertia moment to servo motor inertia moment when gain changing is valid. Setting range: 0 to 3000 ($\times 0.1$ times)	K70
BFM #15048	BFM #15248	PB30	Gain changing Position loop gain	Set the position loop gain when the gain changing is valid. Setting range: 1 to 2000 rad/s	K37
BFM #15049	BFM #15249	PB31	Gain changing Speed loop gain	Set the speed loop gain when the gain changing is valid. Setting range: 20 to 50000 rad/s	K823
BFM #15050	BFM #15250	PB32	Gain changing Speed integral compensation	Set the speed integral compensation when the gain changing is valid. Setting range: 1 to 50000 ($\times 0.1$ ms)	K337
BFM #15051	BFM #15251	PB33	Gain changing Vibration suppression control vibration frequency setting	Set the vibration frequency for vibration suppression control when the gain changing is valid. Setting range: 1 to 1000 ($\times 0.1$ Hz)	K1000

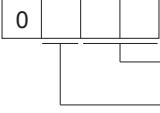
BFM Number		Servo Amplifier Parameter No.	Name	Description	Default
X-axis	Y-axis				
BFM #15052	BFM #15252	PB34	Gain changing Vibration suppression control resonance frequency setting	Set the resonance frequency for vibration suppression control when the gain changing is valid. Setting range: 1 to 1000 (× 0.1 Hz)	K1000
BFM #15063	BFM #15263	PB45	Vibration suppression control filter 2 (Ver.1.40 or later)	<p>Set the vibration suppression control filter 2 setting frequency selection and notch depth selection.</p>  <ul style="list-style-type: none"> • Vibration suppression control filter 2 setting frequency selection 0: Disable 1: 2250 Hz } } 5F: 4.5 Hz • Notch depth selection 0: Deep (-40.0db) } } F: Shallow (-0.6db) 	H0000

11.2.3 Servo parameters (Advanced setting)

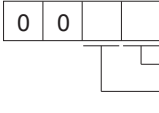
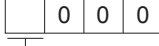
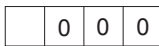
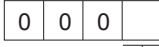
BFM Number		Servo Amplifier Parameter No.	Name	Description	Default
X-axis	Y-axis				
BFM #15064	BFM #15264	PC01	Error excessive alarm level	Set error excessive alarm level with rotation amount of servo motor. Setting range: 1 to 200 REV	K3
BFM #15065	BFM #15265	PC02	Electromagnetic brake sequence output	Set the delay time from when the electronic brake interlock (MBR) turns off until the base drive circuit is shut-off. Setting range: 0 to 1000 ms	K0
BFM #15066	BFM #15266	PC03	Encoder output pulse selection	Select the encoder output pulse direction and encoder pulse output setting.  Encoder output pulse direction 0: 90 degrees in CCW direction (A-phase) 1: 90 degrees in CW direction (A-phase) Encoder output pulse setting 0: With output pulses 1: With output division ratio	H0000
BFM #15067	BFM #15267	PC04	Function selection C-1	Select the encoder cable communication system selection.  Encoder cable communication system selection 0: Two-wire type 1: Four-wire type	H0000
BFM #15068	BFM #15268	PC05	Function selection C-2	Enable or disable the motor-less operation. 0: Disable 1: Enable	K0
BFM #15069	BFM #15269	PC06	Function selection C-3 (Ver.1.40 or later)	Select the error excessive alarm level setting.  Error excessive alarm level setting selection 0: 1REV 1: 0.1REV 2: 0.01REV 3: 0.001REV	H0000
BFM #15070	BFM #15270	PC07	Zero speed	Set the output range of the zero speed signal (ZSP). Setting range: 0 to 10000 r/min	K50
BFM #15072	BFM #15272	PC09*1	Analog monitor 1 output	Select a signal to be output to the analog monitor 1.  Analog monitor 1 (M01) output selection 0: Servo motor speed ($\pm 8V$ at the maximum) 1: Torque ($\pm 8V$ at the maximum) ^B 2: Servo motor speed (+8V at the maximum) 3: Torque (+8V at the maximum) ^B 4: Current command ($\pm 8V$ at the maximum) 5: Speed command ($\pm 8V$ at the maximum) 6: Droop pulses ($\pm 10V/1 \times 10^2$ PLS) ^A 7: Droop pulses ($\pm 10V/1 \times 10^3$ PLS) ^A 8: Droop pulses ($\pm 10V/1 \times 10^4$ PLS) ^A 9: Droop pulses ($\pm 10V/1 \times 10^5$ PLS) ^A A: Feedback position ($\pm 10V/1 \times 10^6$ PLS) ^{A+C} B: Feedback position ($\pm 10V/1 \times 10^7$ PLS) ^{A+C} C: Feedback position ($\pm 10V/1 \times 10^8$ PLS) ^{A+C} D: Bus voltage (+8V / 400V) E: Speed command 2 ($\pm 8V$ at the maximum) *A: Encoder pulse unit *B: Outputs 8V as the maximum torque *C: Can be used for the absolute position detection system	H0000

*1. When using MR-J3W-□B, both axes should have the same setup. (X-axis, Y-axis)

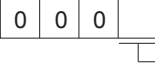
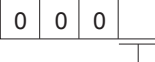
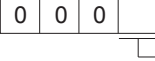
BFM Number		Servo Amplifier Parameter No.	Name	Description	Default
X-axis	Y-axis				
BFM #15073	BFM #15273	PC10*1	Analog monitor 2 output	Select a signal to be output to the analog monitor 2.  Analog monitor 2 (MO2) output selection 0: Servo motor speed ($\pm 8V$ at the maximum) 1: Torque ($\pm 8 V$ at the maximum) ^B 2: Servo motor speed (+8V at the maximum) 3: Torque (+8 V at the maximum) ^B 4: Current command ($\pm 8 V$ at the maximum) 5: Speed command ($\pm 8V$ at the maximum) 6: Droop pulses ($\pm 10 V/1 \times 10^2$ PLS) ^A 7: Droop pulses ($\pm 10 V/1 \times 10^3$ PLS) ^A 8: Droop pulses ($\pm 10 V/1 \times 10^4$ PLS) ^A 9: Droop pulses ($\pm 10 V/1 \times 10^5$ PLS) ^A A: Feedback position ($\pm 10 V/1 \times 10^6$ PLS) ^{A+C} B: Feedback position ($\pm 10 V/1 \times 10^7$ PLS) ^{A+C} C: Feedback position ($\pm 10 V/1 \times 10^8$ PLS) ^{A+C} D: Bus voltage (+8 V / 400 V) E: Speed command 2 ($\pm 8 V$ at the maximum) *A: Encoder pulse unit *B: Outputs 8 V as the maximum torque *C: Can be used for the absolute position detection system	H0001
BFM #15074	BFM #15274	PC11*1	Analog monitor 1 offset	Set the offset voltage of the analog monitor 1 (MO1) output. Setting range: -999 to 999 mV	K0
BFM #15075	BFM #15275	PC12*1	Analog monitor 2 offset	Set the offset voltage of the analog monitor 2 (MO2) output. Setting range: -999 to 999 mV	K0
BFM #15076	BFM #15276	PC13	Analog monitor feedback position output standard data Low (Ver.1.40 or later)	Set the standard position of feedback output with analog monitor 1 (MO1) or 2 (MO2). Setting range: -9999 to 9999 PLS	K0
BFM #15077	BFM #15277	PC14	Analog monitor feedback position output standard data High (Ver.1.40 or later)	Set the standard position of feedback output with analog monitor 1 (MO1) or 2 (MO2). Setting range: -9999 to 9999 ($\times 10000$ PLS)	K0
BFM #15080	BFM #15280	PC17	Function selection C-4	Select the home position setting condition in the absolute position detection system. 0: Need to pass motor Z-phase after power on 1: Not need to pass motor Z-phase after power on	K1
BFM #15083	BFM #15283	PC20*2	Function selection C-7 (Ver.1.40 or later)	Setting when undervoltage alarm occurs  Setting when undervoltage alarm occurs 0: Waveform of power supply voltage is not distorted 1: Set "1" if undervoltage alarm occurs because of distorted power supply voltage waveform when using power regenerative converter or power regeneration common converter	H0000
BFM #15084	BFM #15284	PC21	Alarm history clear (Ver.1.40 or later)	Used to clear the alarm history.  Alarm history clear 0: Disable 1: Enable	H0000
BFM #15087	BFM #15287	PC24	Forced stop deceleration time constant (Ver.1.40 or later)	Only the MR-J3-□BS and MR-J4(W2)-□B Set deceleration time constant for forced stop deceleration. Setting range: 0 to H1FFF	H0000
BFM #15094	BFM #15294	PC31	Vertical axis freefall prevention compensation amount (Ver.1.40 or later)	Only the MR-J3-□BS and MR-J4(W2)-□B Set the compensation amount of the vertical axis freefall prevention function. Setting range: HF63C to H09C4 REV	H0000

*1. When using MR-J3W-□B, both axes should have the same setup. (X-axis, Y-axis)

*2. When using MR-J4W2-□B, both axes should have the same setup. (X-axis, Y-axis)

11.2.4 Servo parameters (I/O setting)

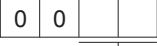
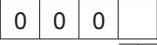
BFM Number		Servo Amplifier Parameter No.	Name	Description	Default
X-axis	Y-axis				
BFM #15102	BFM #15302	PD07	Output signal device selection 1 (CN3-13)	<p>Specify a signal assigned (output) to the CN3-13 connector of the servo amplifier.</p>  <p>Select CN3-13 pin output device</p> <p>00: Always OFF 01: RDY (ready ON) 02: RD (servo ON) 03: ALM (error) 04: INP (In-position) ^{*A} 05: MBR (electronic brake interlock) 06: DB (external dynamic brake) 07: TLC (torque is limited) 08: WNG (warning) 09: BWNG (battery warning) 0A: Always OFF^B 0B: For manufacturer setting^{*C} 0C: ZSP (zero speed) 0D: For manufacturer setting^{*C} 0E: For manufacturer setting^{*C} 0F: CDPS (selecting a variable gain) 10: For manufacturer setting^{*C} 11: ABSV (losing the absolute position) ^{*A} 12 to 3F: For manufacturer setting^{*C}</p> <p>^{*A}: Always OFF in speed control mode ^{*B}: Becomes SA (speed achieved) in speed control mode ^{*C}: Never specify the values for the manufacturer setting.</p>	H0005
BFM #15103	BFM #15303	PD08 ^{*1}	Output signal device selection 2 (CN3-9)	<p>Specify a signal assigned (output) to the CN3-9 connector of the servo amplifier.</p>  <p>Select CN3-9 pin output device</p> <p>00: Always OFF 01: RDY (ready ON) 02: RD (servo ON) 03: ALM (error) 04: INP (In-position) ^{*A} 05: MBR (electronic brake interlock) 06: DB (external dynamic brake) 07: TLC (torque is limited) 08: WNG (warning) 09: BWNG (battery warning) 0A: Always OFF^B 0B: For manufacturer setting^{*C} 0C: ZSP (zero speed) 0D: For manufacturer setting^{*C} 0E: For manufacturer setting^{*C} 0F: CDPS (selecting a variable gain) 10: For manufacturer setting^{*C} 11: ABSV (losing the absolute position) ^{*A} 12 to 3F: For manufacturer setting^{*C}</p> <p>^{*A}: Always OFF in speed control mode ^{*B}: Becomes SA (speed achieved) in speed control mode ^{*C}: Never specify the values for the manufacturer setting.</p>	H0004

*1. When using MR-J4W2-□B, both axes should have the same setup. (X-axis, Y-axis)

11

Buffer Memory

12

Program Example

13

Diagnostics

A

List of Parameters and Data

B

Version Information

BFM Number		Servo Amplifier Parameter No.	Name	Description	Default
X-axis	Y-axis				
BFM #15104	BFM #15304	PD09*1	Output signal device selection 3 (CN3-15)	<p>Specify a signal assigned (output) to the CN3-15 connector of the servo amplifier.</p> <p><input type="text" value="0"/> <input type="text" value="0"/> <input type="text" value=""/> <input type="text" value=""/></p> <p>————— Select CN3-15 pin output device</p> <p>00: Always OFF 01: RDY (ready ON) 02: RD (servo ON) 03: ALM (error) 04: INP (In-position) *A 05: MBR (electronic brake interlock) 06: DB (external dynamic brake) 07: TLC (torque is limited) 08: WNG (warning) 09: BWNG (battery warning) 0A: Always OFF*^B 0B: For manufacturer setting*^C 0C: ZSP (zero speed) 0D: For manufacturer setting*^C 0E: For manufacturer setting*^C 0F: CDPS (selecting a variable gain) 10: For manufacturer setting*^C 11: ABSV (losing the absolute position) *A 12 to 3F: For manufacturer setting*^C</p> <p>*A: Always OFF in speed control mode *B: Becomes SA (speed achieved) in speed control mode *C: Never specify the values for the manufacturer setting.</p>	H0003
BFM #15109	BFM #15309	PD14	Function selection D-3 (Ver.1.40 or later)	<p>Select the warning (WNG) and trouble (ALM) output status at warning occurrence.</p> <p><input type="text" value="0"/> <input type="text" value="0"/> <input type="text" value=""/> <input type="text" value="0"/></p> <p>————— Selection of output device at warning occurrence</p> <p>0: ALM output signal is not turned off upon occurrence of the warning 1: ALM output signal is turned off upon occurrence of the warning*²</p>	H0000

- *1. When using MR-J4W2-□B, both axes should have the same setup. (X-axis, Y-axis)
- *2. Although ALM is turned off upon occurrence of the warning, the forced stop deceleration is performed. (For the MR-J3-□BS, MR-J4-□B)

11.3 Monitor Data

Operating conditions for the positioning system are stored as monitor data. The following buffer memories for monitor data are read-only memories except for the current address (user) [BFM #1, #0 (X-axis), BFM #101, #100 (Y-axis)].

For X-axis: BFM #0 to #99

For Y-axis: BFM #100 to #199

Caution

Do not use unlisted BFM for changing values not described in this section.

11.3.1 Current address (User) [BFM #1, #0, BFM #101, #100]

The current address data is stored in units specified by the user^{*1}.

BFM Number		Description	Value Format	Default
X-axis	Y-axis			
BFM #1,#0	BFM #101,#100	-2,147,483,648 to 2,147,483,647 (user unit) ^{*1}	Decimal	-

*1. Refer to the section shown below for details on the user units.

→ Refer to Section 7.10

POINT

- The stored address data is always handled as an absolute address.
- The unit of the value is a user-specified one and includes a magnification setting for position data. The unit and magnification setting can be specified by the operation parameters 1.
→ For details on the operation parameters 1, refer to Subsection 11.1.1
- It is possible to change the current address of a stopped axis to any address. Overwrite the current address (user) with a new address. The current address will be changed and its pulse data will be updated.
Set a value within the range from 0 to the ring value during the ring operation.
→ For details on the current address change function, refer to Subsection 7.9.9

11.3.2 Current address (Pulse) [BFM #3, #2, BFM #103, #102]

The current address is converted into pulses and stored.

BFM Number		Description	Value Format	Default
X-axis	Y-axis			
BFM #3,#2	BFM #103,#102	-2,147,483,648 to 2,147,483,647 PLS	Decimal	-

POINT

- The stored address data is always handled as an absolute address (converted pulse data).
→ For details on the converted pulse data, refer to Section 7.10
- It is possible to change the current address of a stopped axis to any address. Overwrite the current address (user) with a new address. The current address will be changed and its pulse data will be updated.
Set a value within the range from 0 to the ring value during the ring operation.
→ For details on the current address change function, refer to Subsection 7.9.9

11.3.3 Torque limit storing value [BFM #5, #4, BFM #105, #104]

Torque limit value used for the torque limit function is stored.

The torque limit value is a torque limit setting value, torque output setting value or zero return torque limit value.

→ For details on the torque limit function, refer to Subsection 7.9.3

BFM Number		Description	Value Format	Default
X-axis	Y-axis			
BFM #5,#4	BFM #105,#104	1 to 10,000(× 0.1%)	Decimal	-

11.3.4 Error BFM numbers [BFM #6, BFM #106]

If an error arises, the BFM numbers in which the error occurred are stored.

BFM Number		Description	Value Format	Default
X-axis	Y-axis			
BFM #6	BFM #106	-1: No error Others: BFM number in which an error occurred	Decimal	-

11.3.5 Terminal Information [BFM #7, BFM #107]

Each input terminal status of the 20SSC-H is allocated to a bit status corresponding to each of the input terminals.

BFM Number		Bit Number	Description	Value Format	Default
X-axis	Y-axis				
BFM #7	BFM #107	b0	Becomes ON while the START terminal is used.	Bit	-
		b1	Becomes ON while the DOG terminal is used.		
		b2	Becomes ON while the INT0 terminal is used.		
		b3	Becomes ON while the INT1 terminal is used.		
		b4	Becomes ON while the φA terminal is used.		
		b5	Becomes ON while the φB terminal is used.		
		b6 to b15	Not available		

11.3.6 Servo terminal information [BFM #8, BFM #108]

Each input terminal status of the servo amplifier is allocated with a bit status.

BFM Number		Bit Number	Description	Value Format	Default
X-axis	Y-axis				
BFM #8	BFM #108	b0	Becomes ON while the FLS terminal is used.	Bit	-
		b1	Becomes ON while the RLS terminal is used.		
		b2	Becomes ON while the DOG terminal is used.		
		b3 to b15	Not available		

Point

Allocation cannot be changed for input terminals (DI1 to DI3) of the servo amplifier. DI1 is fixed to "FLS", DI2 is fixed to "RLS", and DI3 is fixed to "DOG".

11.3.7 m code [BFM #9, BFM #109]

At m code ON, the m code number is stored.
At no m code ON, "-1" is stored.

→ For details on the m code, refer to Section 10.9

BFM Number		Description	Value Format	Default
X-axis	Y-axis			
BFM #9	BFM #109	-1 :m code is OFF 0 to 32767 :Stores the activated m code number	Decimal	-

11.3.8 Current value of operation speed [BFM #11, #10, BFM #111, #110]

The current value of the operation speed is stored.
The value becomes zero under suspension, or in operation with a manual pulse input.

BFM Number		Description	Value Format	Default
X-axis	Y-axis			
BFM #11,#10	BFM #111,#110	0 to 2,147,483,647 (user unit) ^{*1}	Decimal	-

*1. Refer to the section shown below for details on the user units.

→ Refer to Section 7.10

11.3.9 Current pulses input by manual pulse generator [BFM #13, #12, BFM #113, #112]

The number of input pulses from the manual pulse generator is stored.
Forward rotation increments the current number of pulses, and reverse rotation decrements it.
Magnification settings for the manual input pulses are not reflected in the stored value.

BFM Number		Description	Value Format	Default
X-axis	Y-axis			
BFM #13,#12	BFM #113,#112	-2,147,483,648 to 2,147,483,647 PLS	Decimal	-

11.3.10 Frequency of pulses input by manual pulse generator [BFM #15, #14, BFM #115, #114]

Manual pulse generator input frequency is stored.

BFM Number		Description	Value Format	Default
X-axis	Y-axis			
BFM #15,#14	BFM #115,#114	-100,000 to 100,000 Hz	Decimal	-

POINT

Magnification settings for the manual input pulses are not reflected on the stored value.

11.3.11 Table numbers in execution [BFM #16, BFM #116]

While performing a table operation, the table number in execution is stored.

BFM Number		Description	Value Format	Default
X-axis	Y-axis			
BFM #16	BFM #116	-1 : Not in execution 0-299 : Stores table number in execution	Decimal	-

11.3.12 Version information [BFM #17]

The version of 20SSC-H is stored.

BFM Number		Description	Value Format	Default
X-axis	Y-axis			
BFM #17	-	Ver.1.00 is stored as K100.	Decimal	-

11.3.13 Real current address (User) [BFM #21, #20, BFM #121, #120]

The Real current address data is stored in units specified by the user^{*1}. (Ver.1.20 or later)

BFM Number		Description	Value Format	Default
X-axis	Y-axis			
BFM #21,#20	BFM #121,#120	-2,147,483,648 to 2,147,483,647 (user unit) ^{*1}	Decimal	-

*1. Refer to the section shown below for details on the user units.

→ Refer to Section 7.10

POINT

- The real current address (user) is "Current address (user) - Deviation counter."
- Units specified by the user are adopted, and the position data magnification is included.

11.3.14 Real current address (Pulse) [BFM #23, #22, BFM #123, #122]

The Real current address is converted into pulses and stored. (Ver.1.20 or later)

BFM Number		Description	Value Format	Default
X-axis	Y-axis			
BFM #23,#22	BFM #123,#122	-2,147,483,648 to 2,147,483,647 PLS	Decimal	-

POINT

- The real current address (pulse) is "Current address (pulse) - Deviation counter."

11.3.15 Received target address [BFM #25, #24, BFM #125, #124]

The target address for the positioning operation currently being executed is stored in units specified by the user^{*1}. (Ver.1.20 or later)

BFM Number		Description	Value Format	Default
X-axis	Y-axis			
BFM #25,#24	BFM #125,#124	-2,147,483,648 to 2,147,483,647 (user unit) ^{*1}	Decimal	-

*1. Refer to the section shown below for details on the user units.

→ Refer to Section 7.10

POINT

- The target address for the table number currently being executed is stored during table operation.
- Variable speed operation is not supported.

11.3.16 Received target speed [BFM #27, #26, BFM #127, #126]

The target speed for the positioning operation currently being executed is stored in units specified by the user^{*1}. (Ver.1.20 or later)

BFM Number		Description	Value Format	Default
X-axis	Y-axis			
BFM #27,#26	BFM #127,#126	-2,147,483,648 to 2,147,483,647 (user unit) ^{*1}	Decimal	-

*1. Refer to the section shown below for details on the user units.

→ Refer to Section 7.10

POINT

- The target speed for the table number currently being executed is stored during table operation.

11.3.17 Status information [BFM #28, BFM #128]

Status of the 20SSC-H can be checked by ON/OFF statuses of each bit.

BFM Number		Bit Number	Description	Value Format	Default
X-axis	Y-axis				
BFM #28	BFM #128	b0	READY/BUSY Turns ON when the 20SSC-H is ready for a START command after normal completion of positioning, or when recovering from an error.	Bit	-
		b1	Outputting pulses for forward rotation. Turns ON while pulses for forward rotation are output.		
		b2	Outputting pulses for reverse rotation. Turns ON while pulses for reverse rotation are output.		
		b3	Completion of zero return operation. Turns ON upon completion of mechanical zero return operation, or when the current position is established by the absolute position detection system. Turns OFF at OFF-to-ON transition of a mechanical zero return command, at power-off (reset), or when an absolute position is lost during the absolute position detection system.		
		b4	Current value overflow. • This bit is set when the current address value falls outside the range of 32-bit data (-2,147,483,648 to 2,147,483,647). • Cleared by power-off or when a zero return command becomes active.		
		b5	Occurrence of an error. • This bit is set upon occurrence of an error from the 20SSC-H or the servo amplifier. • Cleared when an error reset command becomes active. →For details on the statuses at occurrence of errors, refer to Section 13.2		
		b6	Completion of positioning. This bit is set upon normal completion of positioning. ^{*1} Cleared when a START command becomes active, an error occurs, or an error reset command becomes active. When the 20SSC-H is stopped by a STOP command, the bit is kept in OFF status.		
		b7	Ready and waiting for remaining travel after stopping. This bit is set when the 20SSC-H goes into a standby state for the remaining travel upon a STOP command. Cleared by a START command, or when the remaining travel operation is canceled. →For details on the stop command, refer to Section 7.4		
		b8	m code is active. This bit is set when a m code becomes active. When a m code OFF command is received, the bit is cleared. →For details on the m code, refer to Section 10.9		

BFM Number		Bit Number	Description	Value Format	Default
X-axis	Y-axis				
BFM #28	BFM #128	b9	The unit is ready. This bit is set upon completion of 20SSC-H boot-up after power-on. (It is kept in ON state until the power is turned off.) All buffer memory values become valid after the bit is set.	Bit	-
		b10	Transferring servo parameters is in progress. This bit is ON state while transferring servo parameters with a transfer command. It is automatically cleared upon completion of the transfer. →For details on the servo parameters transfer, refer to Subsection 6.2.3 and Section 7.1		
		b11*2	Saving data into flash-memory is in progress. • This bit is ON while saving buffer memory data into flash-memory. • When finished storing the data, the bit is cleared. →For details on storing buffer memory into flash-memory, refer to Subsection 6.2.1 and Section 7.1		
		b12*2	Initialization of buffer memory is in progress. • This bit is ON while initializing data in buffer memories. • When finished initializing the data, the bit is cleared. →For details on initializing buffer memory, refer to Section 7.1		
		b13	Changing speed is in progress. • This bit is set upon receiving a speed change command during positioning operation. • Cleared upon completion of the speed change. →For details on the operation speed change command, refer to Subsection 7.6.2		
		b14	Changing a target address is in progress. This bit is set upon receiving a target address change command during positioning operation. Cleared upon completion of the change of target address. →For details on the target address change command, refer to Subsection 7.6.3		
		b15	Table operation is in progress. This bit is kept in ON status while performing table operation. (It is set by a START command and cleared when the operation is finished.)		

*1. Completion of positioning

1) Operations turning the "positioning completion" bit ON.

- | | |
|--|---|
| <ul style="list-style-type: none"> • Operations turning the "positioning completion" bit ON. <ul style="list-style-type: none"> - Mechanical zero return operation (DOG, stopper type) - 1-speed positioning operation - Interrupt 1-speed constant quantity feed - 2-speed positioning operation - Interrupt 2-speed constant quantity feed - Interrupt stop - Multi-speed operation - Linear interpolation - Linear interpolation (interrupt stop) - Circular interpolation - Reciprocal movement instruction (Ver.1.10 or later) | <ul style="list-style-type: none"> • Operations turning the "positioning completion" bit OFF. <ul style="list-style-type: none"> - Mechanical zero return operation (data set type) - JOG operation - Manual pulse generator operation - Variable speed operation |
|--|---|

2) When stopped at a STOP command

The "Positioning completion" bit does not turn ON at the target address.

*2. BFM #128 b11 and b12 are not available.

11.3.18 Error code [BFM #29, BFM #129]

If an error occurs, the error code is stored.

1. Buffer memories to store error information

If an error occurs, the buffer memories store error information as shown in the table below.

After removing the cause of the error, the system can recover from the error by an error reset command.

Item	Description
No. of BFM in which an error occurred	Number of buffer memory in which an error occurred is stored.
Status information	Becomes active upon detecting an error.
Error code	The error code is stored.
Servo parameter error number	The servo amplifier error code is stored.
Servo status	Turns ON when a servo amplifier error occurs.

2. Error codes

Error codes are stored in decimal format.

→ For details on the error codes, refer to Subsection 13.2.3

11.3.19 Model code [BFM #30]

The model code of the 20SSC-H is stored.

BFM Number		Description	Value Format	Default
X-axis	Y-axis			
BFM #30	-	The model code of the 20SSC-H is K5220.	Decimal	-

11.3.20 Status information 2 [BFM #32, BFM #132]

Status of the 20SSC-H can be checked by ON/OFF statuses of each bit.

BFM Number		Bit Number	Description	Value Format	Default
X-axis	Y-axis				
BFM #32	BFM #132	b0	Positioning parameter change completion flag (Ver. 1.20 or later) <ul style="list-style-type: none"> Turns ON when positioning parameter change is completed. Automatically turns OFF when the positioning parameters enable command turns OFF. 	Bit	H0000
		b1 to b15	Not available		

11.3.21 Current address when an interrupt occurs (INT0) [BFM #35, #34, BFM #135, #134], Current address when an interrupt occurs (INT1) [BFM #37, #36, BFM #137, #136]

The current address when an interrupt input (INT0/INT1) occurs in target positioning operation is stored in user units. (Ver. 1.30 or later)

BFM Number		Description	Value Format	Default
X-axis	Y-axis			
BFM #35, #34	BFM #135, #134	Current address when an interrupt input (INT0) occurs (in user units)	Decimal	-
BFM #37, #36	BFM #137, #136	Current address when an interrupt input (INT1) occurs (in user units)	Decimal	-

Target positioning operations.

Positioning operation	Current address when an interrupt occurs (INT0)	Current address when an interrupt occurs (INT1)
Interrupt 1-speed constant quantity feed	✓	-
Interrupt 1-speed constant Quantity feed (constant position stop mode)	✓	-
Interrupt 2-speed constant quantity feed	✓	✓
Interrupt stop operation	✓	-
Linear interpolation operation (interrupt stop)	✓	-

Note

The error in the calculation of user units is included in the value of the current address when an interrupt occurs.

11.3.22 Deviation counter value [BFM #51, #50, BFM #151, #150]

The deviation counter value of the servo amplifier is stored.

BFM Number		Description	Value Format	Default
X-axis	Y-axis			
BFM #51, #50	BFM #151, #150	Deviation counter value of the servo amplifier (PLS)	Decimal	-

11.3.23 Motor speed [BFM #53, #52, BFM #153, #152]

The present rotation speed of the servo motor is stored.

BFM Number		Description	Value Format	Default
X-axis	Y-axis			
BFM #53, #52	BFM #153, #152	The present rotation speed of the servo motor ($\times 0.1$ r/min)	Decimal	-

11.3.24 Motor current value [BFM #54, BFM #154]

A ratio of the present value of the rated servo motor current is stored.

BFM Number		Description	Value Format	Default
X-axis	Y-axis			
BFM #54	BFM #154	The value of the servo motor current ($\times 0.1\%$)	Decimal	-

11.3.25 Servo amplifier software number [BFM #61 to #56, BFM #161 to #156]

The software number of the servo amplifier is stored.
Updated at control power on to the servo amplifier.

BFM Number		Description	Value Format	Default
X-axis	Y-axis			
BFM #61 to #56	BFM #161 to #156	Servo amplifier software number	ASCII code	-

Note

The servo amplifier software number is stored in ASCII code as shown below.

Example: When the number is -B35W200_A0_ :

BFM Number	Monitor Value	ASCII Code	Servo amplifier software number
BFM #56	H422D	B -	-B35W200_A0_
BFM #57	H3533	5 3	
BFM #58	H3257	2 W	
BFM #59	H3030	0 0	
BFM #60	H4120	A SPACE	
BFM #61	H2030	SPACE 0	

11.3.26 Servo parameter error numbers [BFM #62, BFM #162]

Parameter numbers that cause servo parameter errors are stored.

BFM Number		Description	Value Format	Default
X-axis	Y-axis			
BFM #62	BFM #162	Servo parameter number	Decimal	-

Monitor Values and Servo Parameter Numbers

Stored value	Parameter No.	Stored value	Parameter No.	Stored value	Parameter No.	Stored value	Parameter No.	Stored value	Parameter No.	Stored value	Parameter No.
001	PA01	018	PA18	035	PB17	052	PB34	069	PC06	102	PD07
002	PA02	019	PB01	036	PB18	053	PB35	070	PC07	103	PD08
003	PA03	020	PB02	037	PB19	054	PB36	071	PC08	104	PD09
004	PA04	021	PB03	038	PB20	055	PB37	072	PC09	∴	∴
005	PA05	022	PB04	039	PB21	056	PB38	073	PC10	127	PD32
006	PA06	023	PB05	040	PB22	057	PB39	074	PC11		
007	PA07	024	PB06	041	PB23	058	PB40	075	PC12		
008	PA08	025	PB07	042	PB24	059	PB41	∴	∴		
009	PA09	026	PB08	043	PB25	060	PB42	080	PC17		
010	PA10	027	PB09	044	PB26	061	PB43	∴	∴		
011	PA11	028	PB10	045	PB27	062	PB44	095	PC32		
012	PA12	029	PB11	046	PB28	063	PB45	096	PD01		
013	PA13	030	PB12	047	PB29	064	PC01	097	PD02		
014	PA14	031	PB13	048	PB30	065	PC02	098	PD03		
015	PA15	032	PB14	049	PB31	066	PC03	099	PD04		
016	PA16	033	PB15	050	PB32	067	PC04	100	PD05		
017	PA17	034	PB16	051	PB33	068	PC05	101	PD06		

11.3.27 Servo status [BFM #64, #63, BFM #164, #163]

BFM Number		Bit Number	Description	Value Format	Default
X-axis	Y-axis				
BFM #63	BFM #163	b0	Zero-phase is passed The bit is set when the zero-phase of the encoder is passed.	Bit	-
		b1,b2	Not available		
		b3	Operating at zero speed This bit is set while the motor is driven at speeds lower than "zero speed."		
		b4 to b15	Not available		
BFM #64	BFM #164	b0	Ready ON This bit is set while the servo ready is ON.		
		b1	Servo ON This bit is set while the servo is ON. Cleared when the servo turns OFF.		
		b2 to b6	Not available		
		b7	An alarm has been raised This bit is set while an alarm is raised.		
		b8 to b11	Not available		
		b12	In-position This bit is set while droop pulses are within a range of "In-position."		
		b13	Torque is limited This bit is set while the servo amplifier is limiting torque.		
		b14	Losing an absolute position This bit is set while the servo amplifier is losing an absolute position.		
b15	A warning is occurring This bit is set while a warning is occurring at the servo amplifier.				

11.3.28 Regenerative load ratio [BFM #65, BFM #165]

The regenerative load ratio power to the maximum regenerative power is stored in percentage. With regenerative brake option, the regenerative power ratio to the allowable capacity is stored.

BFM Number		Description	Value Format	Default
X-axis	Y-axis			
BFM #65	BFM #165	Regenerative load ratio (%)	Decimal	-

11.3.29 Effective load torque [BFM #66, BFM #166]

The continuous effective load torque is stored. This parameter stores the average value of the load ratio to the rated torque (100%) from the past 15 seconds.

BFM Number		Description	Value Format	Default
X-axis	Y-axis			
BFM #66	BFM #166	Effective load torque (%)	Decimal	-

11.3.30 Peak torque ratio [BFM #67, BFM #167]

The maximum torque during operations is stored. This parameter stores the peak value to the rated torque (100%) from the past 15 seconds.

BFM Number		Description	Value Format	Default
X-axis	Y-axis			
BFM #67	BFM #167	Peak torque ratio (%)	Decimal	-

11.3.31 Servo warning code [BFM #68, BFM #168]

Warnings detected by the servo amplifier are stored.
Clear the cause of the warning.

- For details on the warnings, refer to the manual of the connected servo amplifier
→ For details on the warning codes, refer to Subsection 13.2.4

11.3.32 Motor feedback position [BFM #71, #70, BFM #171, #170]

Motor feedback positions are stored.

BFM Number		Description	Value Format	Default
X-axis	Y-axis			
BFM #71,#70	BFM #171,#170	Motor feedback position (PLS)	Decimal	-

11.3.33 Servo status 2 [BFM #72, BFM #172]

BFM Number		Bit Number	Description	Value Format	Default
X-axis	Y-axis				
BFM #72	BFM #172	b0	A parameter update completed flag <ul style="list-style-type: none"> This bit is set when an automatic update of servo parameters is completed. Cleared when a servo parameter save command or servo parameter initialization command is finished. 	Bit	-
		b1	Parameter updating flag <ul style="list-style-type: none"> This bit is ON while servo parameters are being updated. 		
		b2	Parameter update request flag <ul style="list-style-type: none"> This bit turns ON when the servo amplifier sends servo parameter update request. 		
		b3 to b15	Not available		

11.3.34 Flash memory write count [BFM #91, #90]

The number of times data is written to the flash memory is stored.

BFM Number		Description	Value Format	Default
X-axis	Y-axis			
BFM #91,#90	-	The number of writes to the flash memory	Decimal	-

Note

The maximum number of writes to the built-in flash memory is 100,000 times.

11.4 Control Data

The control data is user-specified data for controlling the positioning system.

For X-axis: BFM #500 to #599

For Y-axis: BFM #600 to #699

Caution

Do not use unlisted BFMs for changing values not described in this section.

Change of the target address and operation speed

Even if target address 1, target address 2, operation speed 1 and operation speed 2 are changed during positioning operation, the changed contents are not reflected immediately. The changed contents will become valid from the next positioning operation. However, the contents of operation speed 1 are reflected immediately in variable speed operation.

For the functions to change the target address and operation speed during operation, refer to the following.

→ For change of the operation speed and target address, refer to Section 7.6

→ For variable speed operation, refer to Section 9.7

11.4.1 Target address 1 [BFM #501, #500, BFM #601, #600]

This data item sets a target position or travel distance for the positioning operation distance as the target address 1.

BFM Number		Description	Default
X-axis	Y-axis		
BFM #501,#500	BFM #601,#600	Setting range: -2,147,483,648 to 2,147,483,647 [User unit] ^{*1} Set the value within -2,147,483,648 to 2,147,483,647 PLS in the converted pulse data	K0

*1. Refer to the section shown below for details on the user units.

→ Refer to Section 7.10

Note

- The positioning operation differs as follows depending on the procedure to specify the absolute address or relative address.
 - With absolute address: travels from the current position to the target position. The rotation direction depends on whether target address 1 is larger or smaller than the current address.
 - With relative address: moves by the specified travel distance from the current position. The rotation direction depends on the target address sign (+/-).
- The units of the value are user-specified and include the position data magnification.

11.4.2 Operation speed 1 [BFM #503, #502, BFM #603, #602]

This data item sets the operation speed 1 for positioning operations.

BFM Number		Description	Default
X-axis	Y-axis		
BFM #503,#502	BFM #603,#602	Setting range: 1 to 2,147,483,647 [User unit] ^{*1 *2} Set the value within 1 to 50,000,000Hz in converted pulse data.	K1

*1. Refer to the section shown below for details on the user units.

→ Refer to Section 7.10

*2. -2,147,483,648 to 2,147,483,647 with Variable Speed operation.

Note

- Set operation speed 1 lower than the maximum speed. If operation speed 1 exceeds the maximum speed, the 20SSC-H operates at the maximum speed.
- Use the override function or operation speed change function when changing the operation speed during operation.

→ For details of the override function, refer to Subsection 7.6.1

→ For details on the operation speed change function, refer to Subsection 7.6.2

11.4.3 Target address 2 [BFM #505, #504, BFM #605, #604]

This data item sets a target position or travel distance for the positioning operation distance as the target address 2.

BFM Number		Description	Default
X-axis	Y-axis		
BFM #505,#504	BFM #605,#604	Setting range: -2,147,483,648 to 2,147,483,647 [User unit] ^{*1} Set the value within -2,147,483,648 to 2,147,483,647 PLS in the converted pulse data	K0

*1. Refer to the section shown below for details on the user units.

→ Refer to Section 7.10

Note

- The positioning operation differs as follows depending on the procedure to specify the absolute address or relative address.
 - With absolute address: travels from the current position to the target position.
The rotation direction depends on whether target address 2 is larger or smaller than the current address.
 - With relative address: moves by the specified travel distance from the current position. The rotation direction depends on the target address sign (+/-).
- The units of the value are user-specified and include the position data magnification.

11.4.4 Operation speed 2 [BFM #507, #506, BFM #607, #606]

This data item sets the operation speed 2 for positioning operations.

BFM Number		Description	Default
X-axis	Y-axis		
BFM #507,#506	BFM #607,#606	Setting range: 1 to 2,147,483,647 [User unit] ^{*1} Set the value within 1 to 50,000,000 Hz in converted pulse data.	K1

*1. Refer to the section shown below for details on the user units.

→ Refer to Section 7.10

Note

- Set the operation speed 2 lower than the maximum speed.
If the operation speed 2 exceeds the maximum speed, the 20SSC-H operates at the maximum speed.
- Use the override function or operation speed change function when changing the operation speed during operation.
 - For details of the override operation, refer to Subsection 7.6.1
 - For details on the operation speed change function, refer to Subsection 7.6.2

11.4.5 Override setting [BFM #508, BFM #608]

This data item sets an override value for the override function.

→ For details on the override function, refer to Subsection 7.6.1

BFM Number		Description	Default
X-axis	Y-axis		
BFM #508	BFM #608	Setting range: 1 to 30000 (× 0.1%)	K1000

11.4.6 Torque output setting value [BFM #510, BFM #610]

This data item sets an output torque for the torque limit function.

→ For details on the torque limit function, refer to Subsection 7.9.3

BFM Number		Description	Default
X-axis	Y-axis		
BFM #510	BFM #610	Setting range: 0 to 10000 (× 0.1%)	K0

11.4.7 Speed change value [BFM #513, #512, BFM #613, #612]

This data item sets the velocity change value.

→ For details on the operation speed change function, refer to Subsection 7.6.2

BFM Number		Description	Default
X-axis	Y-axis		
BFM #513,#512	BFM #613,#612	Setting range: 1 to 2,147,483,647 [User unit] ^{*1} *2 Set the value within 1 to 50,000,000 Hz in converted pulse data.	K1

*1. Refer to the section shown below for details on the user units.

→ Refer to Section 7.10

*2. -2,147,483,648 to 2,147,483,647 with Variable Speed operation.

11.4.8 Target position change value (Address) [BFM #515, #514, BFM #615, #614]

This data item sets the target address for the target address change function.

→ For details on the target address change function, refer to Subsection 7.6.3

BFM Number		Description	Default
X-axis	Y-axis		
BFM #515,#514	BFM #615,#614	Setting range: -2,147,483,648 to 2,147,483,647 [User unit] ^{*1} Set the value within -2,147,483,648 to 2,147,483,647 PLS in the converted pulse data	K0

*1. Refer to the section shown below for details on the user units.

→ Refer to Section 7.10

11.4.9 Target position change value (Speed) [BFM #517, #516, BFM #617, #616]

This data item sets the operation speed for the target address change function.

→ For details on the target address change function, refer to Subsection 7.6.3

BFM Number		Description	Default
X-axis	Y-axis		
BFM #517,#516	BFM #617,#616	Setting range: 1 to 2,147,483,647 [User unit] ^{*1} Set the value within 1 to 50,000,000 Hz in converted pulse data.	K1

*1. Refer to the section shown below for details on the user units.

→ Refer to Section 7.10

11.4.10 Operation command 1 [BFM #518, BFM #618]

BFM Number		Bit Number	Setting Item	Description	Detection ^{*1}	Default
X-axis	Y-axis					
BFM #518	BFM #618	b0	Error reset	Set this to recover from errors and clear the following information. - Error BFM numbers (BFM #6, BFM #106) - Status information - Occurrence of an error (BFM #28 b5, BFM #128 b5) - Error code (BFM #29, BFM #129)	Edge	H0000
		b1	STOP command (deceleration stop)	When this bit is turned ON during positioning operation, operation decelerates to stop. →For details on the stop command, refer to Section 7.4	Level	
		b2	Forward rotation limit (LSF)	Set this to perform a deceleration stop while outputting pulses for forward rotation. →For details on the forward rotation limit (LSF), refer to Subsection 7.3.2	Level	
		b3	Reverse rotation limit (LSR)	Set this to perform a deceleration stop while outputting pulses for reverse rotation. →For details on the reverse rotation limit (LSR), refer to Subsection 7.3.2	Level	
		b4	Forward rotation JOG	Pulses for forward rotation are output while this is set. →For details on the JOG operations, refer to Section 8.2	Level	
		b5	Reverse rotation JOG	Pulses for reverse rotation are output while this is set. →For details on the JOG operations, refer to Section 8.2	Level	

BFM Number		Bit Number	Setting Item	Description	Detection*1	Default
X-axis	Y-axis					
BFM #518	BFM #618	b6	Mechanical zero return command	When this is set, mechanical zero return operation is started. →For details on the mechanical zero return, refer to Section 8.1	Edge	H0000
		b7	Not available	-	-	
		b8	Relative/Absolute address specification	OFF: An absolute address is used (moves to the specified target address based on the base position). ON: A relative address is used (moves by a specified amount of travel from the current address).	Level	
		b9	START command	Set this to start a positioning operation selected from the operation patterns.	Edge	
		b10*2	Simultaneous START flag	ON: Starts X and Y positioning operations simultaneously when a START command for X-axis becomes active. (includes JOG and zero return operations) OFF: X and Y positioning operations start individually by their respective START commands. (excludes interpolation and XY-table operations)	Level	
		b11	m code OFF	Set this to disable m codes. →For details on the m code, refer to Section 10.9	Edge	
		b12	Change commands during operations are disabled	Set this to disable an operation speed change command and target position change command during operations.	Level	
		b13	Speed change command during positioning operation	Changes the operation speed to the speed preset as a velocity change value during operation. →For details on the operation speed change, refer to Subsection 7.6.2	Edge	
		b14	Target position change command during positioning operation	Changes the target address to the address preset as a target position change value (address or speed) during operations. →For details on the target address change, refer to Subsection 7.6.3	Edge	
		b15	Not available	-	-	

*1. Timing of detection

- 1) Level detection: activated when the bit is set or cleared.
- 2) Edge detection: activated at OFF-to-ON transition.

*2. The simultaneous START flag is b10 in the X-axis operation command 1 (BFM #518).
Do not use b10 in the Y-axis operation command 1 (BFM #618).

Note

- Priority of start flag and stop flag
The STOP command has higher priority over the forward / reverse rotation JOGs and the START command.
- Handling of each flag ON/OFF state
 - The 20SSC-H retains stop and start flag ON/OFF states until power OFF.
 - The commands with level detection executes/stops at writing ON/OFF.
 - For commands with edge detection, create a program so that the bits are always turned OFF upon completion of ON operations.
(The second and subsequent cycles cannot be performed without turning the bits OFF.)

11

Buffer Memory

12

Program Example

13

Diagnostics

A

List of Parameters and Data

B

Version Information

11.4.11 Operation command 2 [BFM #519, BFM #619]

BFM Number		Bit Number	Setting Item	Description	Detection ^{*1}	Default
X-axis	Y-axis					
BFM #519	BFM #619	b0	Remaining travel cancel command	Set this to cancel the standby status for the remaining travel after the STOP command. →For details on the stop command, refer to Section 7.4	Edge	H0000
		b1 ^{*2}	System reset command (Ver.1.10 or later)	Turns ON for 100ms or more, and resets the 20SSC-H system when detecting this bit's falling edge. →For details of the system reset command, refer to Subsection 7.9.12	Edge	
		b2, b3	Not available	-	-	
		b4	Positioning parameters enable command	Set this to enable positioning parameters in the buffer memories. Whenever you make a change to positioning parameters, this bit must be set before starting operation.	Edge	
		b5	Acceleration/deceleration time change command (Ver.1.30 or later)	Select the acceleration/deceleration time setting (except for interpolation operation). →For details of changeover of the acceleration/deceleration time, refer to Section 7.7 OFF: Performs positioning operation using acceleration time and deceleration time. ON: Performs positioning operation using acceleration time 2 and deceleration time 2.	Level	
		b6	Mode selection for the Interrupt 1-speed constant quantity feed (Ver.1.10 or later)	OFF : Relative positioning by the specified travel distance ON : Absolute positioning by the specified address (constant position stop mode) →For details on the interrupt 1-speed constant quantity feed, refer to Section 9.3	Level	
		b7	Interrupt 1-speed Constant Quantity Feed (Constant position stop mode) shortest allowable stop (Ver.1.30 or later)	Enables (makes valid) interrupt 1-speed constant quantity feed (constant position stop mode) shortest allowable stop. →For details of the operation, refer to Subsection 9.3.2 OFF: Performs deceleration stop after detecting an interrupt input. ON: Performs deceleration stop using the shortest deceleration time set by 20SSC-H depending on the position where an interrupt input is detected.	Level	
		b8	Servo OFF command	Set this to turn the servo OFF. →For details on the servo ON/OFF state, refer to Subsection 7.9.5 0: servo ON 1: servo OFF	Level	
		b9	Servo parameters transfer command	Set this to transfer servo parameters in the buffer memories to the servo amplifier.	Edge	
		b10	Gain changing command	Changes the gain of the amplifier from the 20SSC-H. For details on changing gain, refer to the manual shown below. →MR-J3-□B Servo Amplifier Instruction Manual →MR-J3W-□B Servo Amplifier Instruction Manual →MR-J3-□B Safety Servo Amplifier Instruction Manual →MR-J4-□B Servo Amplifier Instruction Manual →MR-J4W2-□B Servo Amplifier Instruction Manual	Level	
		b11	Servo parameter update stop (Ver.1.10 or later)	Set this to disable update of servo parameters even when the servo amplifier gives servo parameter update request. →For details on the servo parameter update stop command, refer to Subsection 7.9.13	Level	
b12 to b15	Not available	-	-			

*1. Timing of detection

- 1) Level detection: activated when the bit is set or cleared.
- 2) Edge detection: activated at OFF-to-ON transition (b1: ON-to-OFF transition).

*2. BFM #619 b1 is not available.

POINT

- 1) When executing the system reset command
Write the model code (K5220) to the "control command enable/disable (BFM #522)" before executing the system reset command.
→ For system reset, refer to Subsection 7.9.12
→ For the control command enable/disable, refer to Subsection 11.4.14
- 2) Changing positioning parameters
When the 20SSC-H is powered ON, operation starts with the positioning parameters in the flash memory. When the buffer memory positioning parameters are changed via FX Configurator-FP or a sequence program, it is necessary to activate the positioning parameters enable command. Without activating the command, changes will not be reflected in actual operation. Changing the positioning parameters enable command must be done when both the Positioning Operation STOP and STOP command state is OFF in order for the changes to become valid.
- 3) Transferring servo parameters
 - a) The following servo parameters are transferred to the servo amplifier when activating the servo parameter transfer command.
The table below shows transferrable servo parameters depending on the setting of the auto tuning mode.

	Auto tuning mode setting status			
	Interpolation mode	Auto tuning mode 1	Auto tuning mode 2	Manual mode
Auto tuning mode	✓	✓	✓	✓
Auto tuning response	✓	✓	✓	✓
Feed forward gain	✓	✓	✓	✓
Ratio of load inertia moment to servo motor inertia moment	*1	*2	✓	✓
Model loop gain	✓	*2	*3	✓
Position loop gain	*1	*2	*3	✓
Speed loop gain	*1	*2	*3	✓
Speed integral compensation	*1	*2	*3	✓
Speed differential compensation	✓	✓	✓	✓

- *1. These parameters are automatically adjusted in the interpolation mode.
*2. These parameters are automatically adjusted in auto tuning mode 1.
*3. These parameters are automatically adjusted in auto tuning mode 2.
- b) During positioning operations or when the STOP command state is ON, the servo parameter transfer command is ignored.
 - c) "Transferring servo parameters" in the status information is ON during the transfer.
→ For details on the status information, refer to Subsection 11.3.17

11.4.12 Operation pattern selection [BFM #520, BFM #620]

BFM Number		Bit Number	Setting Item	Description	Detection*1	Default
X-axis	Y-axis					
BFM #520	BFM #620	b0	1-speed positioning operation	Set this to perform 1-speed positioning operation. →For details on the 1-speed positioning operation, refer to Section 9.2	Level	H0000
		b1	Interrupt 1-speed constant quantity feed	Set this to perform an interrupt 1-speed constant quantity feed. →For details on the interrupt 1-speed constant quantity feed, refer to Section 9.3		
		b2	2-speed positioning operation	Set this to perform 2-speed positioning operation. →For details on the 2-speed positioning operation, refer to Section 9.4		
		b3	Interrupt 2-speed constant quantity feed	Set this to perform an interrupt 2-speed constant quantity feed. →For details on the interrupt 2-speed constant quantity feed, refer to Section 9.5		
		b4	Interrupt stop	Set this to perform an interrupt stop. →For details on the interrupt stop, refer to Section 9.6		

BFM Number		Bit Number	Setting Item	Description	Detection*1	Default
X-axis	Y-axis					
BFM #520	BFM #620	b5	Variable speed operation	Set this to perform a variable speed operation. →For details on the variable speed operation, refer to Section 9.7	Level	H0000
		b6	Operation using the manual pulse generator	Set this to perform an operation with the manual pulse generator. →For details on the manual pulse generator operation, refer to Section 8.3		
		b7	Linear interpolation	Set this to perform a linear interpolation operation. →For details on the linear interpolation operation, refer to Section 9.9		
		b8	Linear interpolation (interrupt stop)	Set this to perform a linear interpolation operation (interrupt stop). →For details on the linear interpolation operation (interrupt stop), refer to Section 9.10		
		b9	Table operation (individual)	Set this to perform an individual table operation. →For details on the table operation (individual), refer to Section 10.1		
		b10	Table operation (simultaneous)	Set this to perform a simultaneous table operation. →For details on the table operation (simultaneous), refer to Section 10.1		
		b11	Reciprocal movement instruction (Ver. 1.10 or later)	Set this to perform a reciprocal movement instruction. →For details on the reciprocal movement instruction, refer to Section 9.12		
		b12 to b15	Not available	-		

*1. Timing of the detection

- 1) Level detection: activated when the bit is set or cleared.
- 2) Edge detection: activated at OFF-to-ON transition.

Note

- The selected operation is started with a START input or START flag.
- The program must be created so that the operation pattern selection is executed before the START input or the START command.
- A positioning operation cannot be started even by the START input or START command when all bits of the operation patterns are OFF, or multiple bits are ON.
(An error occurs if multiple bits are set to ON.)
- When setting the following operations in the operation pattern selection, both axes should be set with the same operation pattern.
If the same operation pattern is not set in both axes, the following operation is executed.
 - 1) Operation patter
 - Liner interpolation
 - Liner interpolation (interrupt stop)
 - Table operation (simultaneous)
 - 2) Action
 - a) When operation pattern above is set to the X-axis and different operation pattern from X-axis is set to the Y-axis
The operation pattern of the Y-axis is disregarded, and operation pattern of the X-axis is executed.
 - b) When a different operation pattern from Y-axis is set to the X-axis and operation pattern above is set to the Y-axis
X-axis: Operates by the operation pattern set in the X-axis.
Y-axis: Does not operate.

11.4.13 Table operation start number [BFM #521, BFM #621]

This data item sets a table information number for the table operation.

→ For details on the table operation, refer to Chapter 10

BFM Number		Description	Default
X-axis	Y-axis		
BFM #521	BFM #621	Setting range: 0 to 299	K0

11.4.14 Control command enable/disable [BFM #522]

This data item enables or disables control commands.

Once the model code is stored, control commands are enabled.

BFM Number		Description	Default
X-axis	Y-axis		
BFM #522		Model code (K5220) :enables control commands Values other than the model code :disables control commands	K0

Note

Write the model code (K5220) to the "control command enable/disable" before executing the system reset command or control command.

After control commands are executed, "0" is automatically stored in the "control command enable/disable."

11.4.15 Control command [BFM #523]

This data item sets data to the buffer memory/the flash memory, or initializes the data.

BFM Number		Bit Number	Setting Item	Description	Detection*1	Default	
X-axis	Y-axis						
BFM #523		b0	Positioning parameters save command	X-axis	Edge	H0000	
		b1		Y-axis			
		b2	Table information save command	X-axis			
		b3		Y-axis			
		b4		XY-axes			
		b5	Servo parameters save command	X-axis			
		b6		Y-axis			
		b7	Not available				-
		b8	Positioning parameters initialization command	X-axis			
		b9		Y-axis			
		b10	Table information initialization command	X-axis			
		b11		Y-axis			
		b12		XY-axes			
		b13	Servo parameters initialization command	X-axis			
		b14		Y-axis			
	b15	Not available		-			

*1. Timing of the detection

- 1) Level detection: activated when the bit is set or cleared.
- 2) Edge detection: activated at OFF-to-ON transition.

Before executing control commands:

Write the model code (K5220) to the "control command enable/disable" before executing control commands. After control commands are executed, "0" is automatically stored in the "control command enable/disable." After a control command is executed, it will automatically turn OFF.

Notes on saving data into flash memory

- The save command is ignored during a positioning operation or when the STOP command state is ON.
- Be sure to note the following points while saving data into the flash memory (status information: ON).
 - Do not turn the power OFF while saving data into the flash memory.
 - If power supply is turned off while saving data into the flash memory, data is not saved correctly to the flash memory, and an error (error code: 4013) occurs the next time the power supply is turned on. In this case, perform the save command again.
 - Do not write any data to buffer memories until saving data into flash memory is completed.
- A memory error occurs when data fails to be saved into the flash memory.
- The maximum number of times data can be written to the flash memory is 100,000 times. The number of times data has been written to the flash memory can be checked by the number of writes.
 - For details on the flash memory maximum number of writes, refer to Subsection 11.3.34

Notes on initializing buffer memories

- While initialization is in progress, the "initializing" status of the status information is ON and READY/BUSY is OFF (BUSY).
- The initialization command is ignored during the positioning operation or when the STOP command state is ON.

11.4.16 Manual pulse generator input magnification (numerator) [BFM #525, #524, BFM #625, #624]

This data item sets the magnification to be applied to the numerator of a pulse train input by the manual pulse generator.

→ For details on the manual pulse generator, refer to Section 8.3

BFM Number		Description	Default
X-axis	Y-axis		
BFM #525,#524	BFM #625,#624	Setting range: 1 to 1,000,000 times	K1

11.4.17 Manual pulse generator input magnification (denominator) [BFM #527, #526, BFM #627, #626]

This data item sets the magnification to the denominator of a pulse train input by the manual pulse generator.

→ For details on the manual pulse generator, refer to Section 8.3

BFM Number		Description	Default
X-axis	Y-axis		
BFM #527,#526	BFM #627,#626	Setting range: 1 to 1,000,000 times	K1

11.4.18 Manual pulse generator response [BFM #528, BFM #628]

Sets the MPG response (Ver.1.10 or later)

→ For details on the manual pulse generator, refer to Section 8.3

BFM Number		Description	Default
X-axis	Y-axis		
BFM #528	BFM #628	Setting range: 1 to 32767	K4

Note

It is possible to change the set value during operation.

- As the set value is smaller, the follow-up capability of output pulses to manual pulse generator inputs is higher.
However, note that the machine may be overloaded if the speed is changed drastically.
- As the set value is larger, the follow-up capability of output pulses to manual pulse generator inputs is lower, but the machine gives smoother motions (outputs).

11.4.19 Manual pulse generator input selection [BFM #529]

Sets the MPG input selection (Ver.1.10 or later)

→ For details on the manual pulse generator, refer to Section 8.3

BFM Number		Description	Default
X-axis	Y-axis		
BFM #529	-	0: X input - X opr / Y input -Y opr 1: X input / Y opr 2: X input - X and Y opr	K0

11.4.20 Ring operation rotation direction for absolute address

Sets the rotation direction when absolute address is specified in the ring operation. (Ver.1.10 or later)

→ For details on the ring counter setting, refer to Section 7.8

BFM Number		Description	Default
X-axis	Y-axis		
BFM #530	BFM #630	0: Direction for shorter rotation 1: Direction where the current value increases (clockwise) 2: Direction where the current value decreases (counterclockwise)	K0

11

Buffer Memory

12

Program Example

13

Diagnostics

A

List of Parameters and Data

B

Version Information

11.5 Table Information

This section shows BFMs for positioning in table operation.

Table numbers and BFM numbers are assigned as shown in the table below.

→ For details on the table operation, refer to Chapter 10

For X-axis :BFM #1000 to #3999

For Y-axis :BFM #4000 to #6999

For XY-axes :BFM #7000 to #12999

Table information when the power is turned ON

When the power is turned ON, the table information stored in the flash memory is transferred to the BFM.

Timing at which the table information is reflected in operations

When "table operation" is set in operation pattern selection and the start input or START command (X-axis: BFM #518 b9, Y-axis: #618 b9) is set to ON from OFF, the table information stored in the BFM set by the operation pattern selection becomes valid.

Table No.	BFM Number			Name		Description	Default	
	X-axis	Y-axis	XY axes					
0	BFM #1001,#1000	-	BFM #7001,#7000	Position information	Position information x	Set target addresses or etc. for the table operation.	K-1	
	-	BFM #4001,#4000	BFM #7003,#7002		Position information y		K-1	
	BFM #1003,#1002	-	BFM #7005,#7004	Speed information	Speed information x	Set the operation speed.	K-1	
	-	BFM #4003,#4002	BFM #7007,#7006		Speed information y		K-1	
	-	-	BFM #7009,#7008	Circular information	Center coordinate i Radius r	Set center coordinate and radius of a circular line for circular interpolation operation	K-1	
	-	-	BFM #7011,#7010		Center coordinate j		K-1	
	BFM #1004	BFM# 4004	BFM #7012	Operation information		Set actions by the table operation.	K-1	
	BFM #1005	BFM# 4005	BFM #7013	m code information		m code is output each time at positioning operation.	K-1	
1	BFM #1011,#1010	-	BFM #7021,#7020	Position information	Position information x	Same as the table 0	K-1	
	-	BFM #4011,#4010	BFM #7023,#7022		Position information y		K-1	
	BFM #1013,#1012	-	BFM #7025,#7024	Speed information	Speed information x		K-1	
	-	BFM #4013,#4012	BFM #7027,#7026		Speed information y		K-1	
	-	-	BFM #7029,#7028	Circular information	Center coordinate i Radius r		K-1	
	-	-	BFM #7031,#7030		Center coordinate j		K-1	
	BFM #1014	BFM #4014	BFM #7032	Operation information				K-1
	BFM #1015	BFM #4015	BFM #7033	m code information				K-1

Table No.	BFM Number			Name		Description	Default
	X-axis	Y-axis	XY axes				
299	BFM #3991,#3990	-	BFM #12981,#12980	Position information	Position information x	Same as the table 0	K-1
	-	BFM #6991,#6990	BFM #12983,#12982		Position information y		K-1
	BFM #3993,#3992	-	BFM #12985,#12984	Speed information	Speed information x		K-1
	-	BFM #6993,#6992	BFM #12987,#12986		Speed information y		K-1
	-	-	BFM #12989,#12988	Circular information	Center coordinate i Radius r		K-1
	-	-	BFM #12991,#12990		Center coordinate j		K-1
	BFM #3994	BFM #6994	BFM #12992	Operation information			K-1
	BFM #3995	BFM #6995	BFM #12993	m code information			K-1

1. Position information

Set the following items according to the table operations set in the operation information.

Table Operation Action	Item	Description
Positioning operation	Set the target address.	Setting range: -2,147,483,648 to 2,147,483,647 [User unit] ^{*1} Set the value within -2,147,483,648 to 2,147,483,647PLS in the converted pulse data.
Changes the current address	Specify the current address (user) after changed.	Setting range: -2,147,483,648 to 2,147,483,647 [User unit] ^{*1} Set the value within -2,147,483,648 to 2,147,483,647PLS in the converted pulse data.
Dwell	Set wait time to be spent for shifting operations.	Setting range: 0 to 32,767 (× 10 ms) ^{*2}
Jump	Sets the table number of the jump address.	Setting range: 0 to 299

*1. Refer to the section shown below for details on the user units.

→ Refer to Section 7.10

*2. The setting range is 0 to 3,276 (× 10 ms) if the version is earlier than Ver. 1.40.

2. Speed data (fx, f, fy)

Sets the operation speed of the positioning operation to be used for table operation.

Setting range: 1 to 2,147,483,647 [User unit]^{*1}

Set the value within 1 to 50,000,000 Hz in converted pulse data.

*1. Refer to the section shown below for details on the user units.

→ Refer to Section 7.10

3. Circular information (i, r, j)

Sets center coordinate and radius for a circular line to be used in circular interpolation operation.

Setting range: -2,147,483,648 to 2,147,483,647 [User unit]^{*1}

Set the value within -2,147,483,648 to 2,147,483,647PLS in the converted pulse data.

*1. Refer to the section shown below for details on the user units.

→ Refer to Section 7.10

4. Operation information

Sets the positioning operation for table operation and changes the current address.
Set the numeric value corresponding to each operation to the operation information.

→ **Refer to Subsection 10.1.3**

5. m code information

m code is output each time at positioning operation.
For instructions on how to use the m code, refer to the following.

→ **Refer to Section 10.9**

No code -1
m code after mode 0 to 9999
m code with mode 10000 to 32767

12. Program Example

STARTUP AND MAINTENANCE PRECAUTIONS



WARNING

- Do not touch any terminal while the PLC's power is on.
Doing so may cause electric shock or malfunctions.
- Before cleaning or retightening terminals, cut off all phases of the power supply externally.
Failure to do so may cause electric shock.
- Before modifying or disrupting the program in operation or running the PLC, carefully read through this manual and the associated manuals and ensure the safety of the operation.
An operation error may damage the machinery or cause accidents.
- Before operating the Zero-return/JOG or testing of the positioning data, carefully read through this manual and the associated manuals and ensure the safety of the operation.
An operation error may damage the machinery or cause accidents.

STARTUP AND MAINTENANCE PRECAUTIONS



CAUTION

- Do not disassemble or modify the PLC.
Doing so may cause fire, equipment failures, or malfunctions.
For repair, contact your local Mitsubishi Electric representative.
- Turn off the power to the PLC before connecting or disconnecting any extension cable.
Failure to do so may cause equipment failures or malfunctions.
- Turn off the power to the PLC before attaching or detaching the following devices.
Failure to do so may cause equipment failures or malfunctions.
 - Peripheral devices, expansion boards, and special adapters
 - Extension units/blocks and FX Series terminal blocks

12.1 Reading/Writing Buffer Memory

12.1.1 Assigned unit number

1. Assigned unit number

The unit number for the 20SSC-H is automatically assigned No.0 to No.7 starting from the special function unit/block closest to the PLC main unit.

- In the FX3U, FX3UC (D, DS, DSS) series

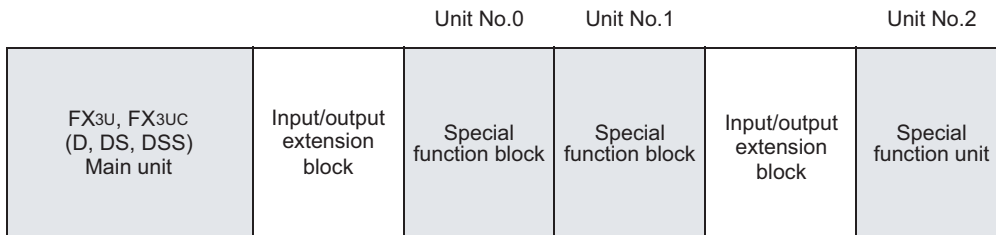

- In the FX3UC-32MT-LT, FX3UC-32MT-LT-2

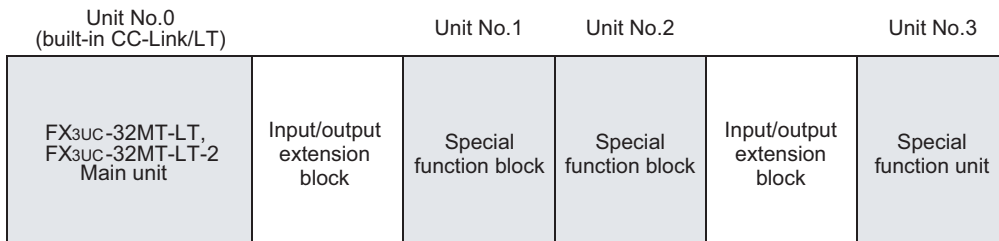

12.1.2 How to read/write from/to buffer memory

To read and write the buffer memory in the 20SSC-H, use the FROM/TO instructions or direct specification of the buffer memory.

FX3U/FX3UC PLC applicable software is required to perform direct specification of the buffer memory and bit specification of word devices.

→ For details of applied instructions, bit specification of word devices and direct specification of the buffer memory, refer to the PROGRAMMING MANUAL

Note

Buffer memory that is assigned in 32 bits must use 32-bit instructions to read/write.

Data cannot be correctly read/written from/to buffer memory assigned in 32 bits if 16-bit read/write instructions are used.

1. How to read and write numeric values

- Direct specification of buffer memory

Specify the buffer memory directly as the source or destination in applied instructions, and then read or write the contents of the buffer memory.

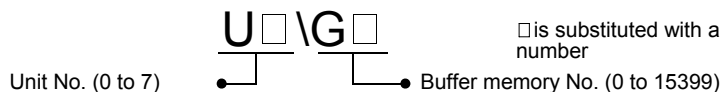

- Reading and transferring numeric values to data registers

In the program below, the contents of the buffer memory (BFM #0 and #1) in unit No. 1 are read and transferred to data registers (D10 and D11).

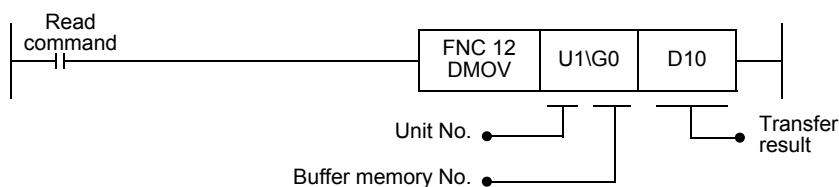

- b) Writing numeric values to the buffer memory
 In the program below, "K5,000,000" is written to the buffer memory (BFM #501 and #500) in unit No. 1.

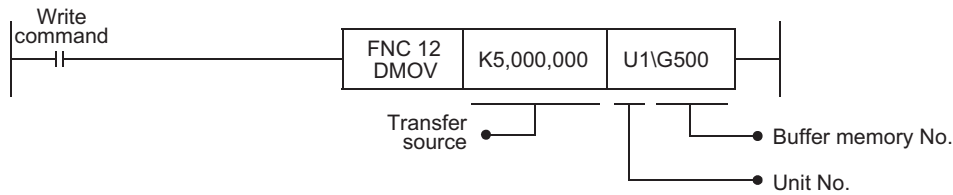

- c) Writing the current value of data registers to the buffer memory
 In the program below, the current value of data registers (D21 and D20) is written to the buffer memory (BFM #501 and #500) in unit No. 1.

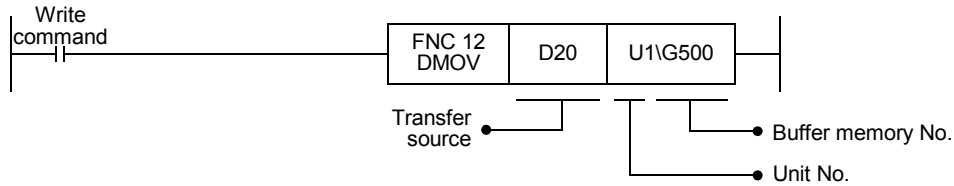

- 2) FROM/TO instructions (conventional method)
 Read and write the contents of the buffer memory using the FROM/TO instructions.

- a) Reading and transferring numeric values to data registers (FROM instruction)
 In the program below, the contents of the buffer memory (BFM #1 and #0) in unit No. 1 are read and transferred to data registers (D11 and D10).

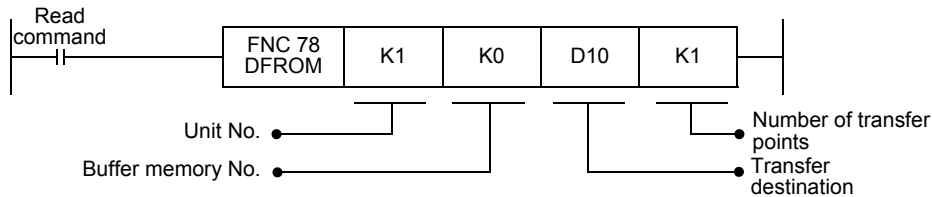

- b) Writing numeric values to the buffer memory (TO instruction)
 In the program below, "K5,000,000" is written to the buffer memory (BFM #501 and #500) in unit No. 1.

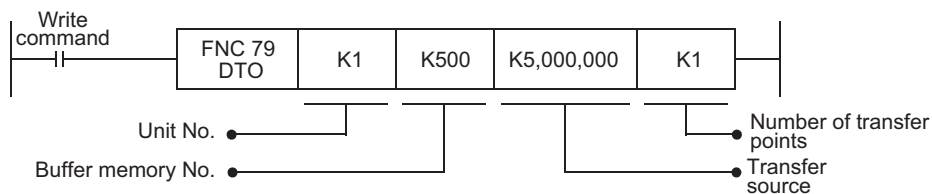

- c) Writing the current value of data registers to the buffer memory (TO instruction)
 In the program below, the current value of data register (D21 and D20) is written to the buffer memory (BFM #501 and #500) in unit No. 1.

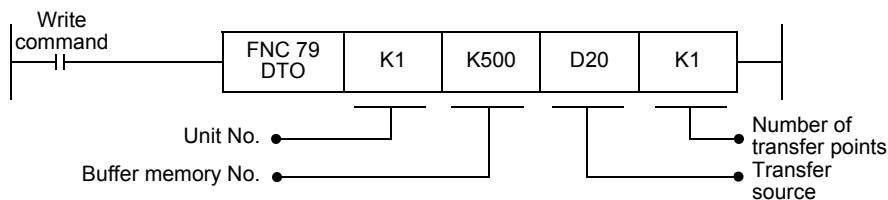

2. How to read and write the bit information such as status information and operation command 1

1) Direct specification of buffer memory

Specify the buffer memory directly as the source or destination in applied instructions, and read or write the contents..



a) Reading and transferring the bit information to auxiliary relays

In the program below, the contents of the buffer memory (BFM #28) in unit No. 1 are read and transferred to auxiliary relays (M40 to M55).

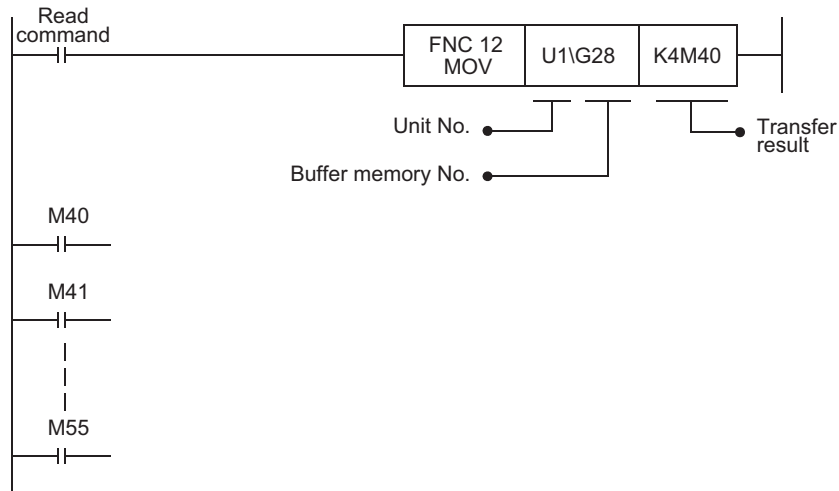

b) Reading and transferring bit information to data registers

In the program below, the contents of the buffer memory (BFM #28) in unit No. 1 are read and transferred to a data register (D200). The read bit information is used in bit specification of word devices.

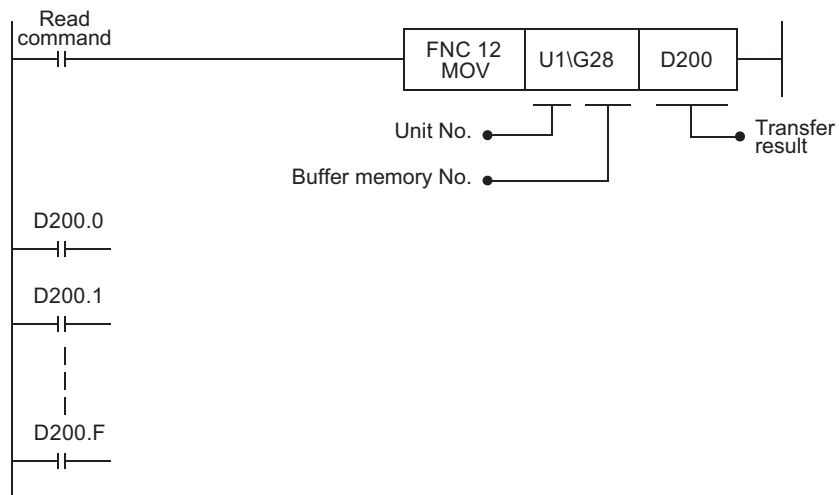

- c) Writing bit information of auxiliary relays to the buffer memory
In the program below, the ON/OFF status of auxiliary relays (M20 to M35) is written to the buffer memory (BFM #518) in unit No. 1.

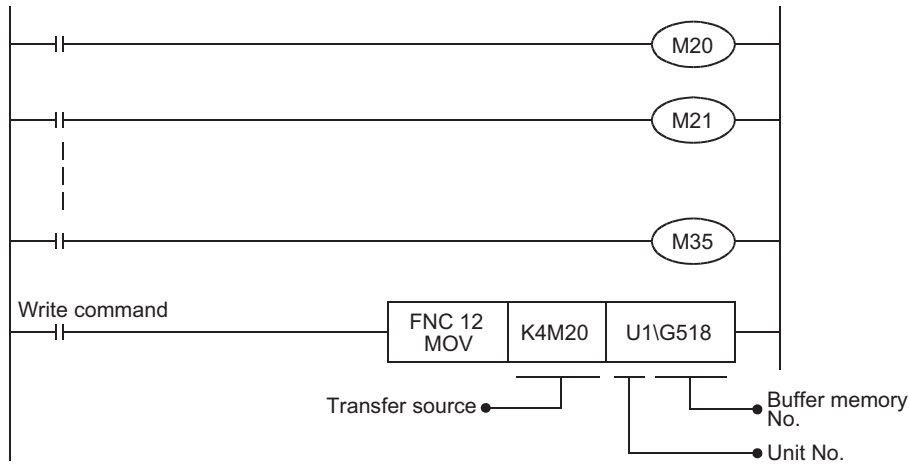

- d) Writing bit information stored in data registers to the buffer memory
In the program below, the ON/OFF status of each bit of a data register (D201) is written to the buffer memory (BFM #518) in unit No. 1. Each bit of the data register (D201) should be set to ON or OFF in advance by bit specification of word devices.

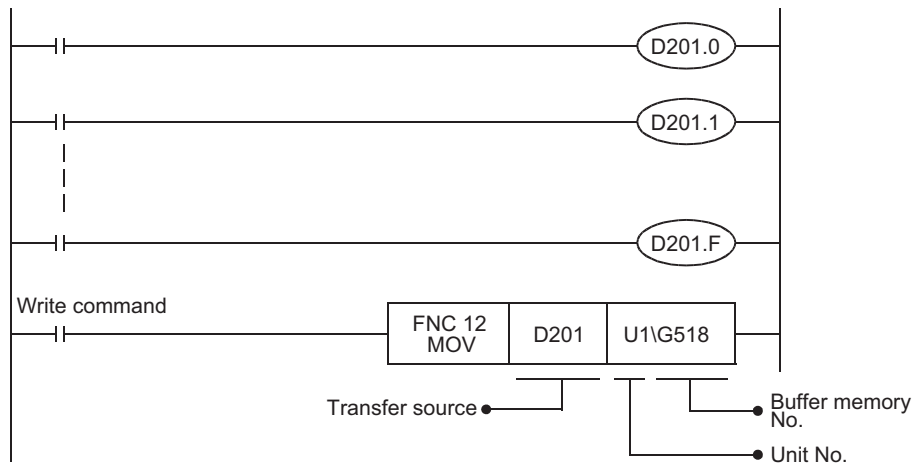

2) FROM/TO instructions (conventional method)

Read and write the contents of the buffer memory using the FROM/TO instructions.

- a) Reading and transferring bit information to auxiliary relays

In the program below, the contents of the buffer memory (BFM #28) in unit No. 1 are read and transferred to auxiliary relays (M40 to M55).

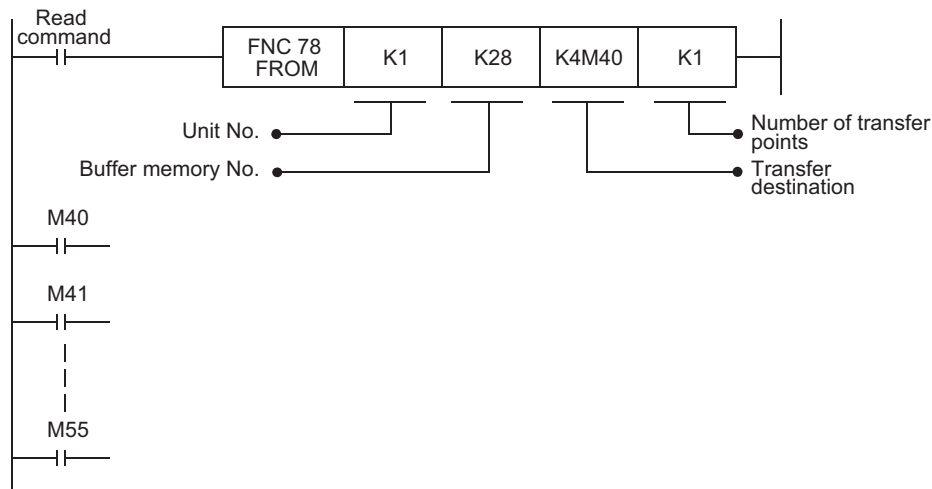

b) Reading and transferring bit information to data registers

In the program below, the contents of the buffer memory (BFM #28) in unit No. 1 are read and transferred to a data register (D200). The read bit information is used in bit specification of word devices.

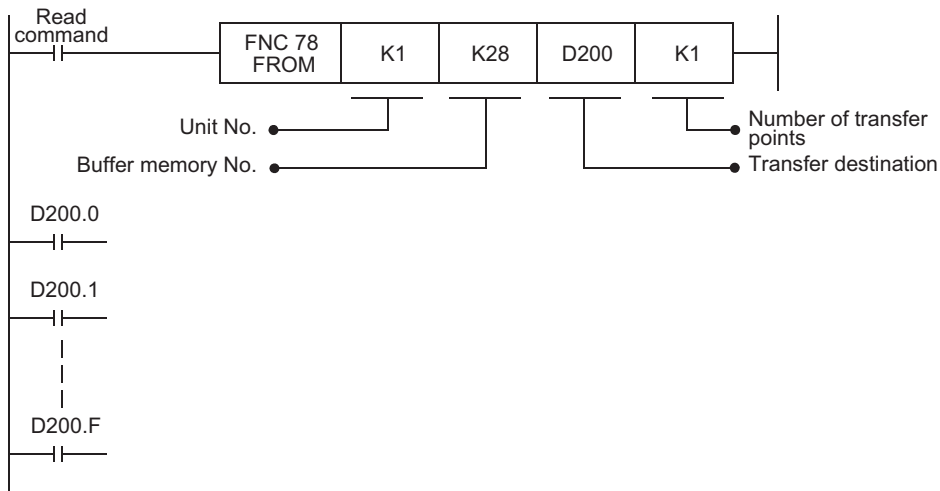

c) Writing bit information of auxiliary relays to the buffer memory

In the program below, the ON/OFF status of auxiliary relays (M20 to M35) is written to the buffer memory (BFM #518) in unit No. 1.

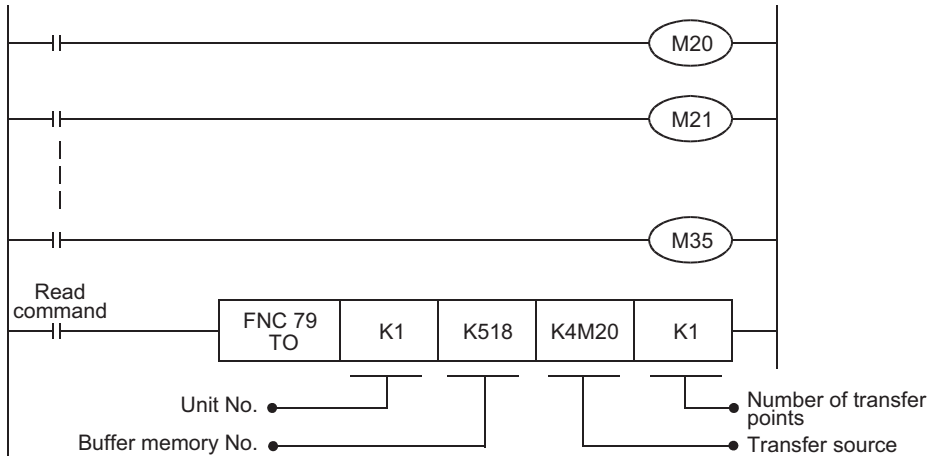

d) Writing bit information stored in data registers to the buffer memory

In the program below, the ON/OFF status of each bit of a data register (D201) is written to the buffer memory (BFM #518) in unit No. 1. Each bit of the data register (D201) should be set to ON or OFF in advance by bit specification of word devices.

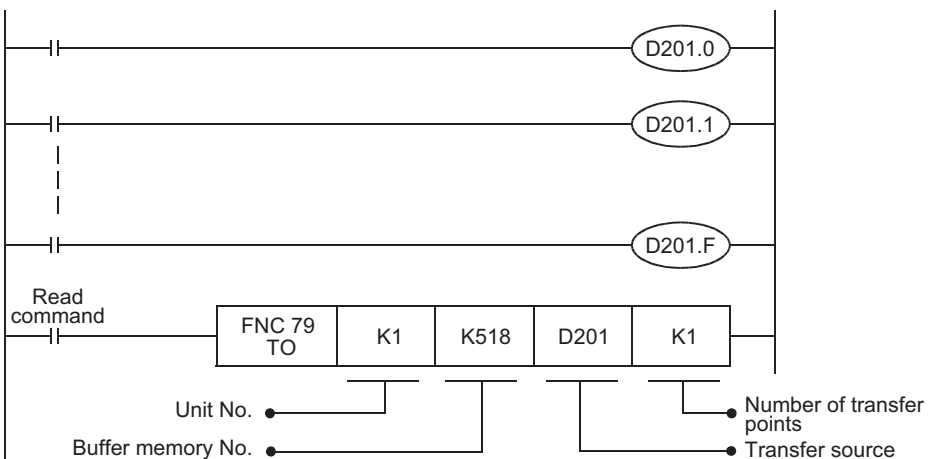

12.2 Device Assignments

Name	Device No.		Remark	
	X-axis	Y-axis		
Input				
Error reset	X000	X010		
STOP	X001	X011		
Forward rotation limit	X002	X012	Use external wiring with NC contacts.	
Reverse rotation limit	X003	X013		
Forward rotation JOG	X004	X014		
Reverse rotation JOG	X005	X015		
Mechanical zero return command	X006	X016		
START command	X007	X017		
Selection of 1-speed positioning operation	X020	X021		
Selection of table operation (individual)	X022	X023		
Selection of table operation (simultaneous)	X024	-		
Control data				
Operation pattern selection	1-speed Positioning operation	M0	M100	
	Interrupt 1-speed constant quantity feed	M1	M101	
	2-speed Positioning operation	M2	M102	
	Interrupt 2-speed constant quantity feed	M3	M103	
	Interrupt stop	M4	M104	
	Variable speed operation	M5	M105	
	Manual pulse generator	M6	M106	
	Linear interpolation operation	M7	M107	
	Linear interpolation (interrupt stop) operation	M8	M108	
	Table operation (individual)	M9	M109	
	Table operation (simultaneous)	M10	M110	
	Reciprocal movement instruction	M11	M111	
	Not available	M11 to M15	M111 to M115	Always OFF
	Operation command 1	Error reset	M20	M120
STOP command		M21	M121	
Forward rotation limit		M22	M122	
Reverse rotation limit		M23	M123	
Forward rotation JOG		M24	M124	
Reverse rotation JOG		M25	M125	
Mechanical zero return command		M26	M126	
Not available		M27	M127	Always OFF
Relative/absolute address specification		M28	M128	
START command		M29	M129	
Simultaneous start flag		M30	M130	M130 for the Y-axis is always used in OFF.
m code OFF command		M31	M131	
Change command in operation disabled		M32	M132	
Speed change command in positioning control		M33	M133	
Target position change command in positioning control		M34	M134	
Not available	M35	M135	Always OFF	
Target address 1	D501, D500	D601, D600		
Operation speed 1	D503, D502	D603, D602		
Table operation start No.	D521	D621		

11

Buffer Memory

12

Program Example

13

Diagnostics

A

List of Parameters and Data

B

Version Information

Name	Device No.		Remark	
	X-axis	Y-axis		
Monitor data				
Status information	READY	M40	M140	
	During forward rotation pulse output	M41	M141	
	During reverse rotation pulse output	M42	M142	
	Zero return completed	M43	M143	
	Current value overflow	M44	M144	
	Error occurrence	M45	M145	
	Positioning completion	M46	M146	
	Standby for remaining travel distance at STOP	M47	M147	
	m code ON	M48	M148	
	Unit ready	M49	M149	
	During servo parameters transfer	M50	M150	
	Saving to flash memory	M51	M151	Use M51 for both the X-axis and the Y-axis.
	Initializing buffer memory	M52	M152	Use M52 for both the X-axis and the Y-axis.
	During operation speed change	M53	M153	
	During target address change	M54	M154	
During table operation execution	M55	M155		
Current address (user)	D1, D0	D101, D100		
Error BFM No.	D6	D106		
m code No.	D9	D109		
Operation speed present value	D11, D10	D111, D110		
Number of the table in operation	D16	D116		
Error code	D29	D129		
Motor rotation speed	D53, D52	D153, D152		
Servo status	D64	D164		
Servo warning code	D68	D168		
Motor feedback position	D71, D70	D171, D170		

12.3 Explanation of Operation

This section describes operation of the example program.
Positioning control parameters are used with their default settings.

- For details on device assignments, refer to Section 12.2
- For details on sequence programs, refer to Section 12.4

Note

- **Set the servo series in the servo parameters according to the servo amplifier to be used.**
→ Refer to Section 7.1 and 11.2
- Set the following parameters if necessary.
→ For details, refer to Section 7.1 and Chapter 11
 - Function selection (C-4) for servo parameters
 - Zero return interlock setting in positioning parameters

12.3.1 Mechanical zero return

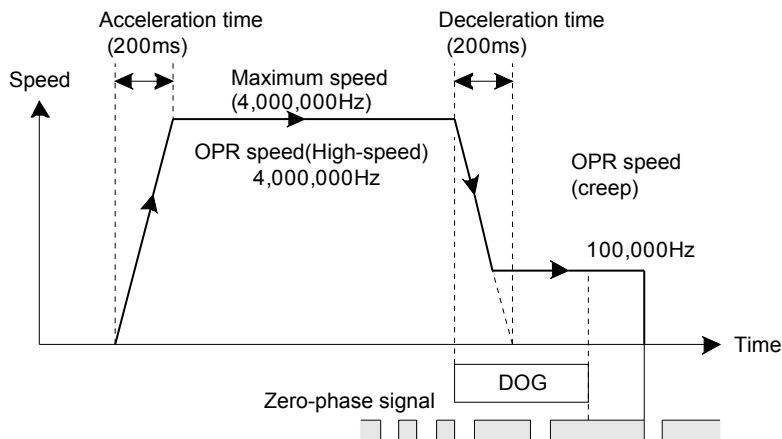

X-axis

- 1) When turning X006 "X-axis mechanical zero return command" to ON at the PLC main unit, DOG type mechanical zero return operation starts in the current value decrementing direction.
- 2) When turning the DOG ON, the operation decelerates to the zero return speed (creep).
- 3) When turning the DOG OFF, the operation stops at the zero-phase signal of the motor, and the mechanical zero-point address is stored to the current value. (zero-point signal count: 1 time)

Y-axis

- 1) When turning X016 "Y-axis mechanical zero return command" to ON at the PLC main unit, DOG type mechanical zero return operation starts in the current value decrementing direction.
- 2) When turning the DOG ON, operation decelerates to the zero return speed (creep).
- 3) When turning the DOG OFF, the operation stops at the zero-phase signal of the motor, and the mechanical zero-point address is stored to the current value. (zero-point signal count: 1 time)

12.3.2 JOG operation

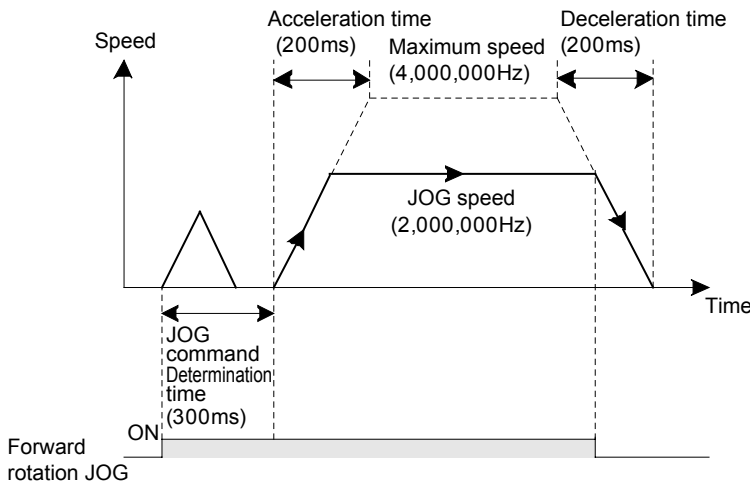

X-axis

- When turning X004 "X-axis forward rotation JOG" to ON at the PLC main unit, the JOG operation starts in the current value incrementing direction.
- When turning X005 "X-axis reverse rotation JOG" to ON at the PLC main unit, the JOG operation starts in the current value decrementing direction.

Y-axis

- When turning X014 "Y-axis forward rotation JOG" to ON at the PLC main unit, the JOG operation starts in the current value incrementing direction.
- When turning X015 "Y-axis reverse rotation JOG" to ON at the PLC main unit, the JOG operation starts in the current value decrementing direction.

11	Buffer Memory
12	Program Example
13	Diagnostics
A	List of Parameters and Data
B	Version Information

12.3.3 1-speed positioning operation

The 1-speed positioning operation operates by the drive for incrementing. The positioning operates at constant quantity feed.

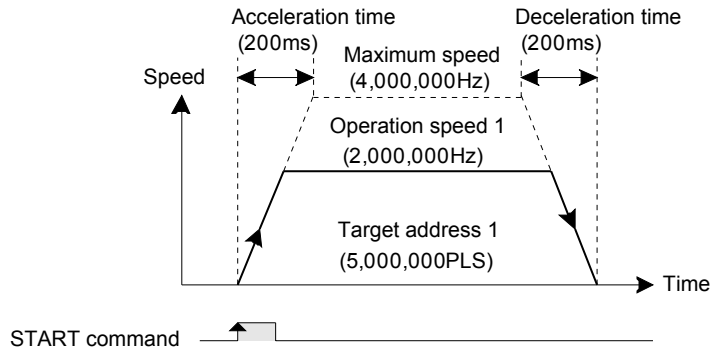

X-axis

- When turning X007 "X-axis START command" to ON with X020 "X-axis selection of 1-speed positioning operation" turned ON at the PLC main unit, the 1-speed positioning operation starts. After 5,000,000 pulses of travel in the current value incrementing direction, the operation decelerates to stop.
- When X007 is turned ON again, positioning starts with the same travel distance again. (The state of X020 "X-axis selection of 1-speed positioning operation" on the PLC main unit changes from OFF to ON).
- When turning X001 "X-axis stop" to ON during positioning, the operation decelerates to stop.

Y-axis

- When turning X017 "Y-axis START command" to ON with X021 "Y-axis selection of 1-speed positioning operation" turned ON at the PLC main unit, the 1-speed positioning operation starts. After 5,000,000 pulses of travel in the current value incrementing direction, the operation decelerates to stop.
- When X017 is turned ON again, positioning starts with the same travel distance again. (The state of X021 "Y-axis selection of 1-speed positioning operation" on the PLC main unit changes from OFF to ON).
- When turning X011 "Y-axis stop" to ON during positioning, the operation decelerates to stop.

12.3.4 Multi-speed operation [table operation (individual)]

Multi-speed operation works in table operation. In this example, multi-speed operation functions by the drive to increment.

1. Operation details

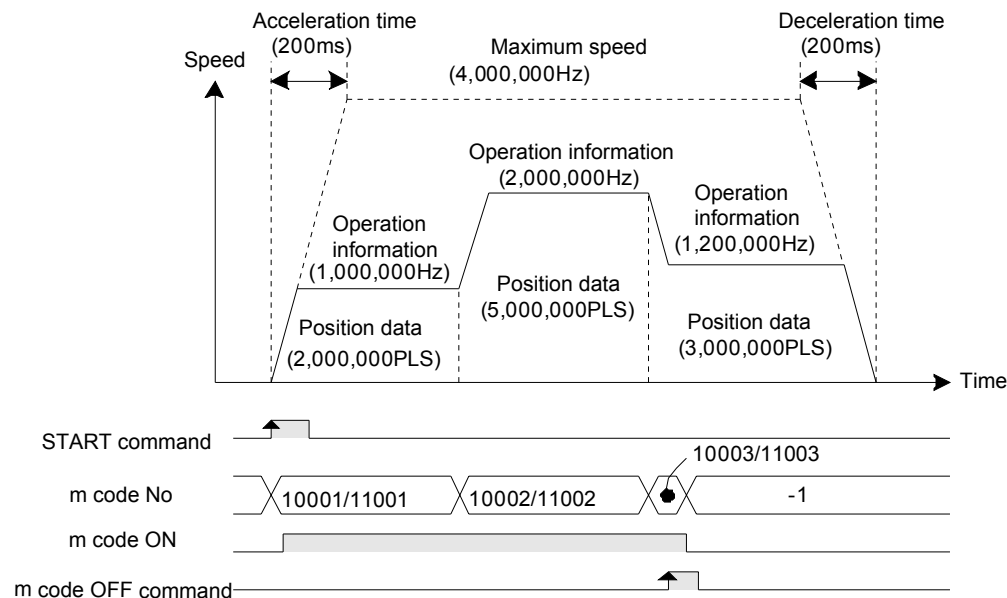

X-axis

- When turning X007 "X-axis START command" to ON with X022 "X-axis selection of table operation (individual)" turned ON, multi-speed operation starts with the preset X-axis table information. After 10,000,000 pulses of travel in the current value incrementing direction, operation decelerates to stop.
- When turning X007 "X-axis START command" to ON after the table operation ends, the positioning operates by the same travel distance again.
- When turning X001 "X-axis stop" to ON during positioning, the positioning decelerates to stop.
- m codes are output in the with mode. At the start of each operation, the m code ON flag becomes "1" and the m code number is stored. When the m code number of 10003, the m code OFF command turns ON, and the m code turns OFF.

Y-axis

- When turning X017 "Y-axis START command" to ON with X023 "Y-axis selection of table operation (individual)" turned ON, multi-speed operation starts with the preset Y-axis table information. After 10,000,000 pulses of travel in the current value incrementing direction, operation decelerates to stop.
- When turning X017 "Y-axis START command" to ON after the table operation ends, the positioning operates by the same travel distance again.
- When turning X011 "Y-axis stop" to ON during positioning, the positioning decelerates to stop.
- m codes are output in the with mode. At the start of each operation, the m code ON flag becomes "1" and the m code number is stored. When the m code number of 11003, the m code OFF command turns ON, and the m code turns OFF.

2. Setting table information

Set the X-axis/Y-axis table information as follows in FX Configurator-FP.

1) X-axis table information

No.	Command code	Address [PLS]	Speed [Hz]	Time [10ms]	Jump No.	m code
0	Incremental address specification					-1
1	Operation at multi-step speed	2000000	1000000			10001
2	Operation at multi-step speed	5000000	2000000			10002
3	Operation at multi-step speed	3000000	1200000			10003
4	End					
5						

2) Y-axis table information

No.	Command code	Address [PLS]	Speed [Hz]	Time [10ms]	Jump No.	m code
0	Incremental address specification					-1
1	Operation at multi-step speed	2000000	1000000			11001
2	Operation at multi-step speed	5000000	2000000			11002
3	Operation at multi-step speed	3000000	1200000			11003
4	End					
5						

11 Buffer Memory

12 Program Example

13 Diagnostics

A List of Parameters and Data

B Version Information

12.3.5 Circular interpolation operation [table operation (simultaneous)]

Circular interpolation operation works in table operation. In this example, circular interpolation operation functions by the drive to increment.

1. Operation details

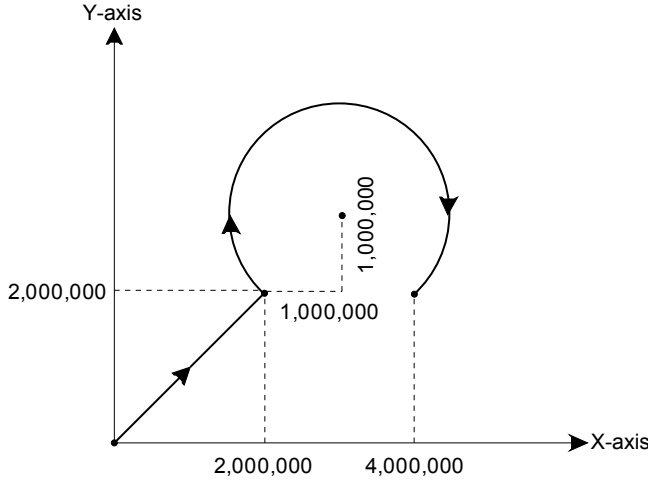

XY-axis

- When turning X007 "X-axis START command" to ON with X024 "X-axis selection of table operation (simultaneous)" turned ON, operation starts in the order of the XY-table information.
 - 1) Linear interpolation operation
 - 2) Dwell
 - 3) Circular interpolation operation
 - 4) End
- When turning X001 "X-axis stop" to ON during positioning, operation decelerates to stop.

2. Setting table information

Set the XY-axis table information as follows on FX Configurator-FP.

No.	Command code	Address x:[PLS] y:[PLS]	Speed fx:[Hz] fy:[Hz]	Arc center i:[PLS] j:[PLS]	Arc radius r:[PLS]	Time [10ms]	Jump No.	m code
0	Incremental address specification							-1
1	Linear interpolation	x: 2000000 y: 2000000	fx: 1000000					-1
2	Dwell					100		-1
3	Circular interpolation(CNT,CW)	x: 2000000 y: 0	fx: 1000000	i: 1000000 j: 1000000				-1
4	End							
5								

12.4 Sequence Program

This program example describes the sequence program as unit No.0.
Rewrite the unit No. with the actual system configuration to be used.

- For details on the unit No., refer to Subsection 12.1.1
- For details on device assignments, refer to Section 12.2
- For an explanation of operation, refer to Section 12.3

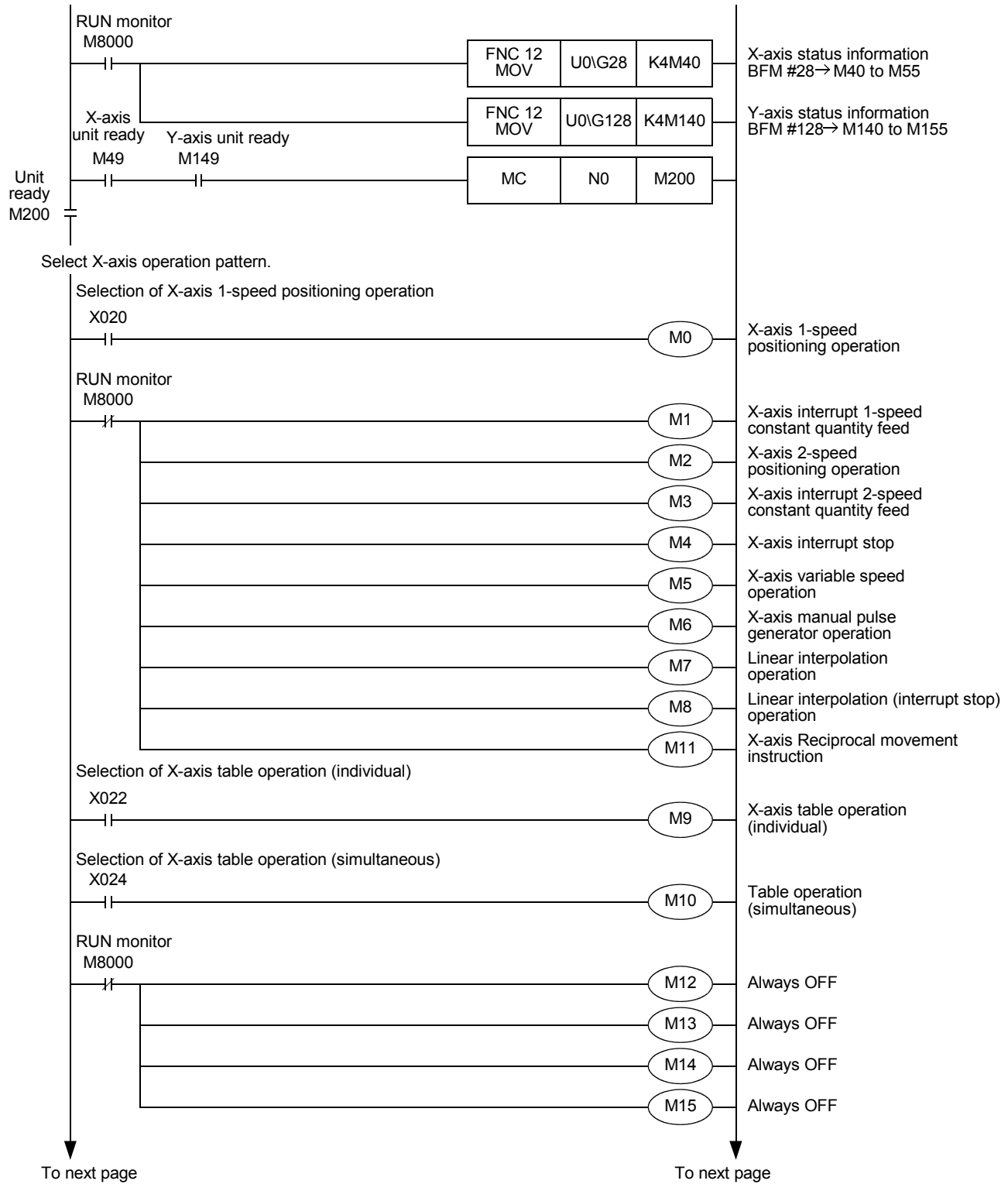

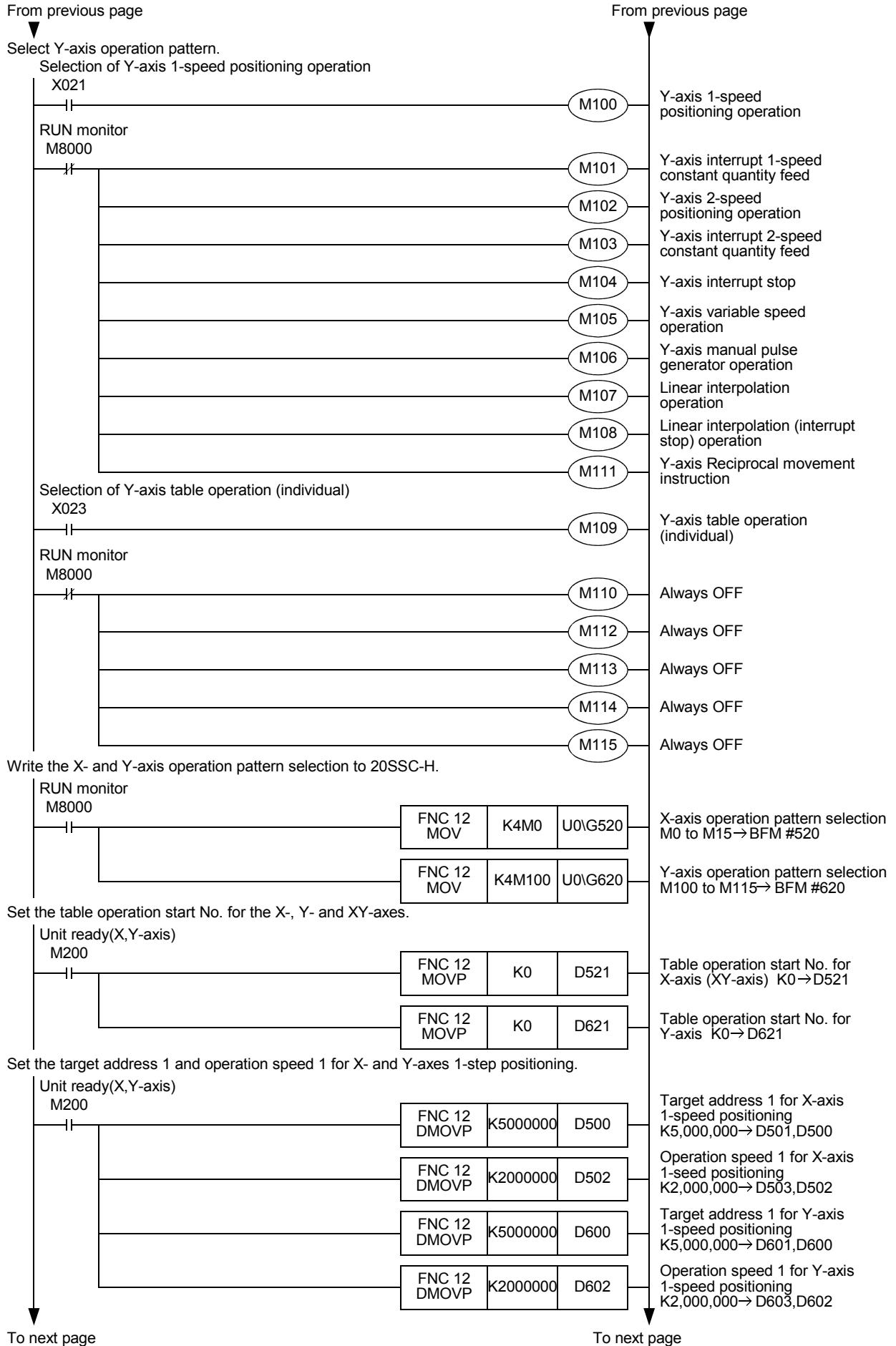

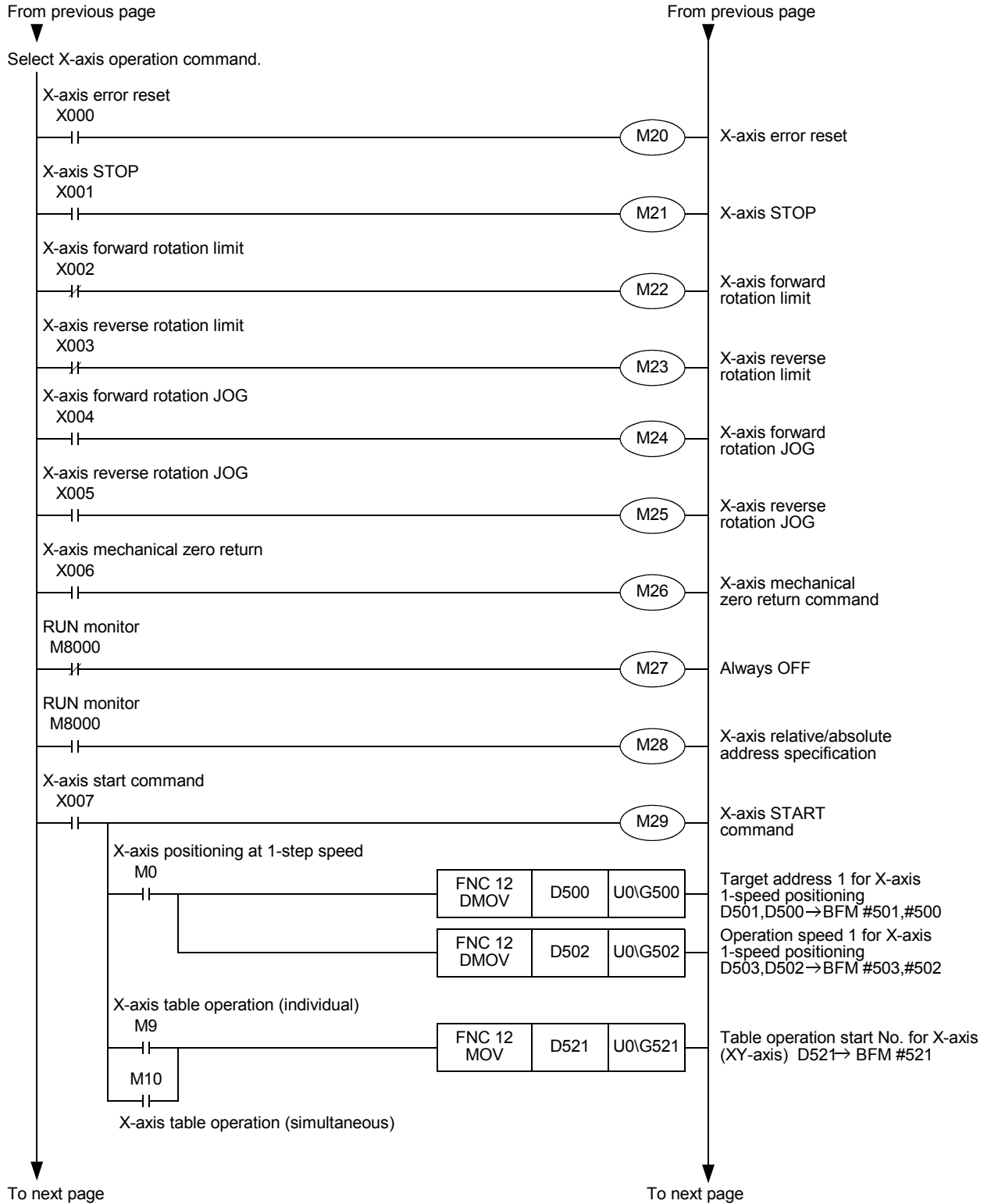

11 Buffer Memory

12 Program Example

13 Diagnostics

A List of Parameters and Data

B Version Information

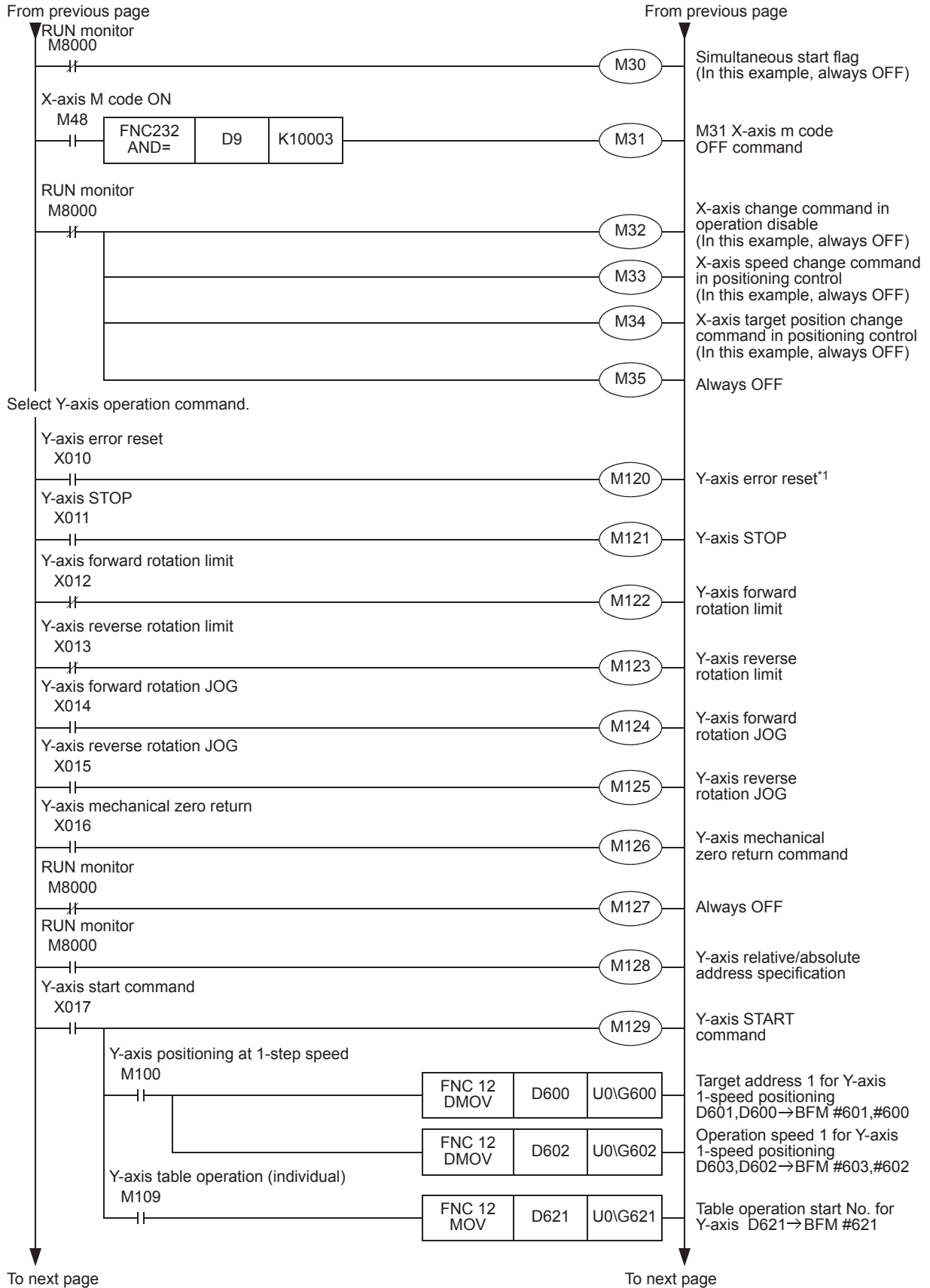

*1. Programming of this circuit is not required when interpolation operation is executed.

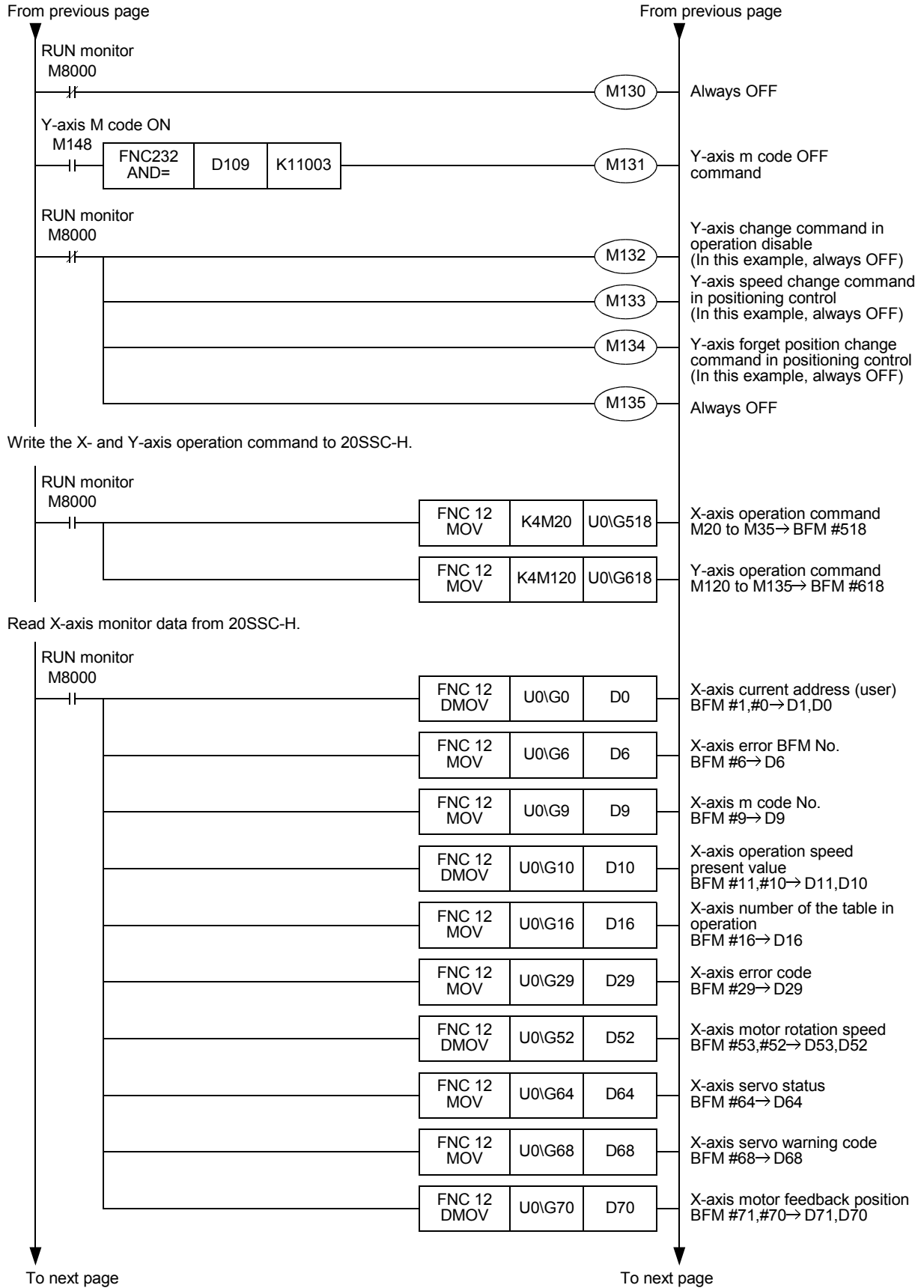

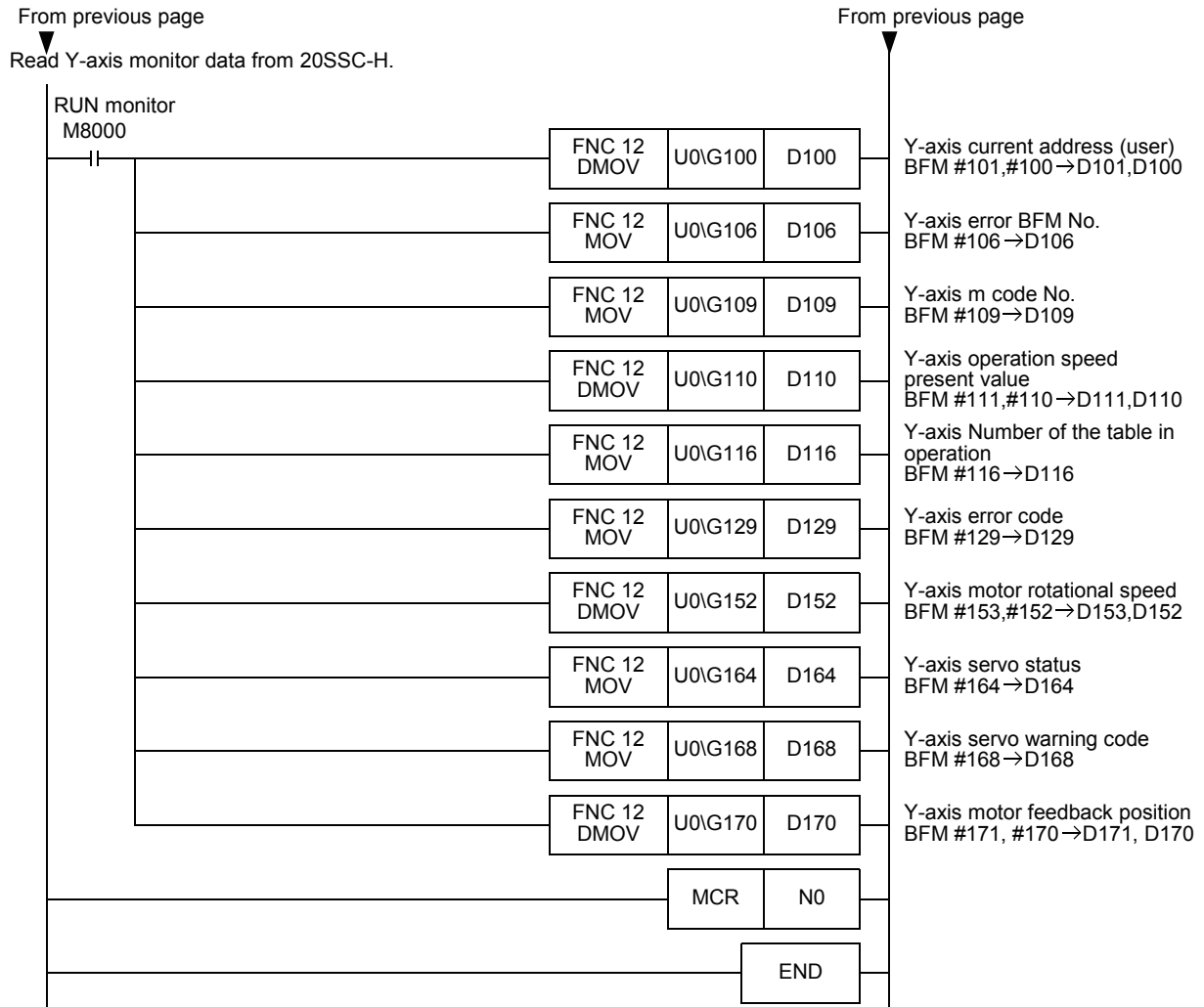

13. Diagnostics

When a fault occurs, check the power supply voltage, the PLC main unit and I/O devices for loose terminal screws, and examine the connectors for a defective contact.

STARTUP AND MAINTENANCE PRECAUTIONS



WARNING

- Do not touch any terminal while the PLC's power is on.
Doing so may cause electric shock or malfunctions.
- Before cleaning or retightening terminals, cut off all phases of the power supply externally.
Failure to do so may cause electric shock.
- Before modifying or disrupting the program in operation or running the PLC, carefully read through this manual and the associated manuals and ensure the safety of the operation.
An operation error may damage the machinery or cause accidents.
- Before operating the Zero-return/JOG or testing of the positioning data, carefully read through this manual and the associated manuals and ensure the safety of the operation.
An operation error may damage the machinery or cause accidents.

STARTUP AND MAINTENANCE PRECAUTIONS



CAUTION

- Do not disassemble or modify the PLC.
Doing so may cause fire, equipment failures, or malfunctions.
For repair, contact your local Mitsubishi Electric representative.
- Turn off the power to the PLC before connecting or disconnecting any extension cable.
Failure to do so may cause equipment failures or malfunctions.
- Turn off the power to the PLC before attaching or detaching the following devices.
Failure to do so may cause equipment failures or malfunctions.
 - Peripheral devices, expansion boards, and special adapters
 - Extension units/blocks and FX Series terminal blocks

11

Buffer Memory

12

Program Example

13

Diagnostics

A

List of Parameters and Data

B

Version Information

13.1 Check LEDs

13.1.1 Check LEDs

LED Indication	Color Indication	State	Content of Error	Action
POWER	Green	Off	No power supply from the external power supply and PLC main unit.	<ul style="list-style-type: none"> Correctly connect the extension cable and power cable. Correctly connect the wiring to the external power supply. When the service power supply of the PLC main unit is in use, make sure that the supply capacity is not being exceeded.
		On	Power is supplied from the external power supply and PLC main unit.	The power supply is normal.
X-READY Y-READY	Green	Off	An error has occurred on the X-axis/ Y-axis, or positioning control is being executed.	When the stop command is input, the positioning operation stops, and the LED lights. If the LED does not light even after a stop, an error has occurred. Check the error and remove the cause.
		On	The X-axis/Y-axis cannot accept operation commands.	-
X-ERROR Y-ERROR	Red	Off	No error	-
		Flashing	An error has occurred.	An error has occurred on the 20SSC-H. Check the error code, and perform the action according to the content of the error. For details on error codes, refer to the following: →Refer to Subsection 13.2.3
		On	CPU error	If the 20SSC-H does not restore the problem at power ON again, consult your local Mitsubishi Electric representative.

13.1.2 Input LED state indications

LED Indication	Color Indication	State	Content of Error	Action
X-START Y-START	Red	Off	START input OFF	If the LED does not light even if input is ON, check the input wiring. The 20SSC-H inputs START, DOG, INT0, and INT1 require an external power supply (24VDC).
X-DOG Y-DOG	Red	Off	DOG input OFF	
X-INT0 Y-INT0 X-INT1 Y-INT1	Red	Off	INT0, INT1 input OFF	
X-φA Y-φA	Red	Off	Manual pulse generator A-phase input OFF	If the LED does not flash even at pulse input from the manual pulse generator, check the input wiring.
X-φB Y-φB	Red	Off	Manual pulse generator B-phase input OFF	

13.2 Check Error Code

13.2.1 Checking errors

When an error or warning (servo amplifier) occurs, error or warning information is stored to the following buffer memories.

FX Configurator-FP and programming tool check the error by monitoring, and so does a sequence program.

Item		BFM number		Content
		X-axis	Y-axis	
Monitor data				
Error occurrence BFM No.		BFM #6	BFM #106	When an error occurs, the BFM No. with error is stored. -1: No error occurrence Other: BFM No. with error →Refer to Subsection 11.3.4
Status information	Error occurrence	BFM #28 b5	BFM #128 b5	This is set when a 20SSC-H and servo amplifier error occurs. This can be reset by an error reset. →Refer to Subsection 11.3.17
Error code		BFM #29	BFM #129	When an error occurs, an error code is stored. →Refer to Subsection 13.2.3
Servo parameter error No.		BFM #62	BFM #162	When a servo parameter error occurs, the parameter No. of the servo parameter that is in error is stored. →Refer to Subsection 11.3.26
Servo status	In alarm	BFM #64 b7	BFM #164 b7	This turns ON at a servo alarm. →Refer to Subsection 11.3.27
	In warning	BFM #64 b15	BFM #164 b15	This turns ON at the servo amplifier warning. →Refer to Subsection 11.3.27
Servo warning code		BFM #68	BFM #168	The warning detected by the servo amplifier is stored. →Refer to Subsection 13.2.4

13.2.2 How to reset an error

After detecting and removing the cause of the error, reset the error by performing an error reset.

How to reset an error

1) Turn the following bit from OFF to ON by the sequence program, or by the programming tool.

Item		BFM number		Content
		X-axis	Y-axis	
Control data				
Error reset		BFM #518 b0	BFM #618 b0	When this turns ON at an error, an error reset is performed, and the following information is cleared. - Error occurrence BFM No. (BFM #6, BFM #106) - Status information Error occurrence (BFM #28 b5, BFM #128 b5) - Error code (BFM #29, BFM #129) →Refer to Subsection 11.4.10

2) Perform an error reset with FX Configurator-FP.

Point

- At a servo parameter error
Correct the servo parameter, save the correct parameter to the 20SSC-H flash memory, and reboot the 20SSC-H and servo amplifier.
- Alarms and warnings detected on the servo amplifier
The servo amplifier requires a reboot depending on the content of the alarm and warning.
→ For details on countermeasures, refer to Subsection 13.2.3 and 13.2.4

13.2.3 Error code list [BFM #29 (X-axis), BFM #129 (Y-axis)]

When an error occurs, an error code is stored in decimal to BFM #29 (X-axis) and BFM #129 (Y-axis).

Error category	Error Code (decimal)	Error Content	Action
-	0	No error	-
Setting error	2	Incorrect value range A value outside of the setting range is set to the buffer memory.	Change the setting value in buffer memory so that it is within the setting range.
	3	Value overflow The converted pulse data (e.g. travel distance or operation speed) exceeds 32 bits.	Change the setting value of the corresponding buffer memory so that the converted pulse data is smaller than 32-bit data.
	5	The operation pattern has Multiple operation patterns	Change the program in the PLC main unit so that only one operation pattern is selected.
	6	Center coordinate setting error When one of the following applies: - Start point = center coordinate - End point = center coordinate - Center coordinate is outside of the -2,147,483,648 to 2,147,483,647 PLS range	Check the center coordinate setting and set so that a circle is formed.
Control errors	3000	Table operation start No. error The table No. is executed outside of the range 0 to 299.	Change the table operation start No. to 0 to 299.
	3001	Jump No. fault The jump No. for the table information is set outside the range 0 to 299.	Change the jump No. for the table information to 0 to 299.
	3002	Command format fault The operation information of the table information is set by a non-defined number.	Change the operation information of the table information.
	3004	Current value overflow at absolute value detection system The converted pulse data of the current address exceeds 32 bits.	Turn the power OFF, or perform a mechanical zero return or data set type zero return.
	3005	Manual pulse generator input error	Change the pulse generator input (numerator) and pulse generator input (denominator) settings.
	3006	Interpolation error during ring operation Linear interpolation, linear interpolation (interrupt stop) or circular interpolation is performed while the ring operation is set.	Reset the ring operation setting before executing the interpolation.

Error category	Error Code (decimal)	Error Content	Action
External errors	4002	Servo end error The in-position signal did not turn ON during the servo end determination time.	Increase the servo end determination time setting.
	4003	Servo ready error The servo motor ready signal did not turn ON at operation start or during operation.	Check the servo motor and encoder cable.
	4004	Forward rotation limit, reverse rotation limit error • The forward rotation limit 1 (LSF) and reverse rotation limit 1 (LSR) are ON. • The forward rotation limit 2 (FLS) and reverse rotation 2 (RLS) limit are ON.	<ul style="list-style-type: none"> Check the wiring of the forward/reverse rotation limit, limit switches and the program. Check the external signal selection (positioning parameter) settings. Retract from the forward/reverse rotation limit by JOG operation or manual pulse generator input operation.
	4005	Software limit error The current address exceeds the software upper and lower limits.	<ul style="list-style-type: none"> Correct the target address. Set the current value to within the software limit range by JOG operation manual pulse generator input operation.
	4006	Servo amplifier EM1 or EM2 is OFF.	Ensure safety and deactivate the forced stop.
	4007	ABS error The current position could not be established.	<ul style="list-style-type: none"> Make sure to use a servo motor with absolute position detection. Make sure to use the battery for the servo motor to retain the origin position. Make sure that the absolute position detection system in servo parameters is valid. Check the servo motor and encoder cable.
	4008	The data for restoring the absolute position was not saved at the time of zero return completion.	<ul style="list-style-type: none"> Reduce the creep speed. Extend the In-position range. Perform the gain adjustment.
	4009	Encoder error 1 During operation, the variation of the encoder current value changes as follows: "Encoder current value variation/1.7[ms] > motor 180°"	<ul style="list-style-type: none"> Check the servo motor and encoder cable. Adopt the noise suppression measures as described in the manual for the servo amplifier.
	4010	Encoder error 2 During operation, the following condition occurred: "encoder current value (encoder unprocessed data) [PLS] ≠ feedback current value (servo amplifier internal data) [PLS] (number of encoder valid bits)."	<ul style="list-style-type: none"> Check the servo motor and encoder cable. To reduce noise, follow the servo amplifier manual.
	4011	SSCNET III communication error SSCNET III cable communication error	<ul style="list-style-type: none"> Check the SSCNET III cable connection. Wipe off any dirt from the end surface. Change the SSCNET III cable. To reduce noise, follow the servo amplifier manual.
Major errors	4013	Power OFF during write to flash memory Data in flash memory is invalid when the power is turned OFF while the flash memory is being written to.	<ul style="list-style-type: none"> Save the positioning parameter to the flash memory again. Save the servo parameter to the flash memory again. Save the table informaton to the flash memory again. Execute a zero return again.
	4015	STO signal OFF error (Only the MR-J3-□BS and MR-J4(W2)-□B)	<ul style="list-style-type: none"> Properly connect the STO I/O signal connector. Change the STO cable. Change MR-J3-D05. Change the external device, or review the setting.
	9000	Memory error	If this error occurs after rebooting and initializing the 20SSC-H, the module needs repair. Consult your local Mitsubishi Electric representative.
	9001	Sum check error	
9002	Watchdog timer error		
9003	Hardware error		

11

Buffer Memory

12

Program Example

13

Diagnostics

A

List of Parameters and Data

B

Version Information

Error category	Error Code (decimal)	Error Content	Action
Servo amplifier	Error code, error content and action are given for the MR-J3-□B(S). Parentheses () in the error code column indicate the LED display of the MR-J3-□B(S). →For the MR-J3W-□B, refer to the MR-J3W-□B Instruction Manual →For the MR-J4-□B, refer to the MR-J4-□B Instruction Manual →For the MR-J4W2-□B, refer to the MR-J4W2-□B Instruction Manual →For details on how to check errors and actions, refer to the manual of the servo amplifier to be connected		
	2010 (10)	Undervoltage <ul style="list-style-type: none"> MR-J3-□B: Power supply voltage dropped to 160VAC or less MR-J3-□B1: Power supply voltage dropped to 83VAC or less MR-J3-□B4: Power supply voltage dropped to 280VAC or less 	Review the power supply
	2012 (12)	Memory error 1 (RAM) RAM, memory fault (in servo amplifier)	The servo amplifier must be repaired. Consult your local Mitsubishi Electric representative.
	2013 (13)	This error occurs depending on the order with which the peripheral devices are powered OFF.	Make sure to Power-OFF the 20SSC-H and the servo amplifier at the same time or Power-OFF the servo amplifier before the 20SSC-H. The direction above does not apply to products manufactured after June 2006.
		Clock error <ul style="list-style-type: none"> Faulty board Clock error transmitted from 20SSC-H 	The servo amplifier or 20SSC-H must be repaired. Consult your local Mitsubishi Electric representative.
	2014 (14)	CPU watchdog error <ul style="list-style-type: none"> Servo amplifier hardware error 	
	2015 (15)	Memory error 2 (EEPROM) <ul style="list-style-type: none"> EEPROM error (in servo amplifier) The EEPROM write count exceeds 100,000 operations. 	The servo amplifier must be repaired. Consult your local Mitsubishi Electric representative.
	2016 (16)	Encoder error 1 (after power-on) <ul style="list-style-type: none"> Communication error occurred between sensor and servo amplifier. 	<ul style="list-style-type: none"> Connect correctly. Change the servo motor. Repair or change the cable. Correct the setting of the 4th digit of parameter No. PC04.
	2017 (17)	Board error <ul style="list-style-type: none"> CPU/part fault 	The servo amplifier must be repaired. Consult your local Mitsubishi Electric representative.
	2019 (19)	Memory error 3 (Flash ROM) <ul style="list-style-type: none"> ROM memory fault 	
	2020 (20)	Encoder error 2 (during runtime) <ul style="list-style-type: none"> Communication error occurred between sensor and servo amplifier. 	<ul style="list-style-type: none"> Connect correctly. Change the servo motor. Repair or change the cable.
	2021 (21)	Encoder error 3 (during runtime) Error occurred in encoder.	Change the servo motor.
	2024 (24)	Main circuit error <ul style="list-style-type: none"> Ground fault occurred at the servo motor power (U, V and W phases) of the servo amplifier. 	<ul style="list-style-type: none"> Correct the wiring. Change the cable. Change the servo amplifier.
	2025 (25)	Absolute position erase <ul style="list-style-type: none"> Absolute position data in error Power was switched ON for the first time in the absolute position detection system. 	<ul style="list-style-type: none"> After leaving the alarm occurring for a few minutes, switch power OFF, then ON again. Always create the home position setting again. Change the battery. Always set the home position again.
2030 (30)	Regenerative alarm <ul style="list-style-type: none"> The permissible regenerative power of the built-in regenerative brake resistor or regenerative brake option is exceeded. Regenerative transistor fault 	<ul style="list-style-type: none"> Correct the setting of the regenerative brake option (servo parameter). →Refer to Subsection 11.2.1 Correctly connect the built-in regenerative brake resistor or regenerative brake option. High-duty operation or continuous regenerating operation to exceed the permissible regenerative power of the regenerative brake option. <ul style="list-style-type: none"> Reduce the frequency of positioning. Change the regenerative brake option to the one with a larger capacity. Reduce the load. Review the power supply Change the servo amplifier or regenerative brake option. 	

Error category	Error Code (decimal)	Error Content	Action
Servo amplifier	Error code, error content and action are given for the MR-J3-□B(S). Parentheses () in the error code column indicate the LED display of the MR-J3-□B(S). →For the MR-J3W-□B, refer to the MR-J3W-□B Instruction Manual →For the MR-J4-□B, refer to the MR-J4-□B Instruction Manual →For the MR-J4W2-□B, refer to the MR-J4W2-□B Instruction Manual →For details on how to check errors and actions, refer to the manual of the servo amplifier to be connected		
	2031 (31)	Overspeed • The rotation speed has exceeded the instantaneous permissible speed.	<ul style="list-style-type: none"> When the acceleration/deceleration overshoots, check the acceleration/deceleration time constant in the fixed parameters. If the servo gain cannot be set to a proper value: <ul style="list-style-type: none"> Reduce the load inertia moment ratio (servo parameter) of the servo motor. →Refer to Subsection 11.2.2 Review the acceleration/deceleration time constant. Change the servo motor.
	2032 (32)	Overcurrent • The current flow is higher than the permissible current of the servo amplifier.	<ul style="list-style-type: none"> Correct the wiring. Change the servo amplifier. Adopt noise suppression measures.
	2033 (33)	Overvoltage • The following shows the input value of converter bus voltage. <ul style="list-style-type: none"> MR-J3-□B: 400VDC or more MR-J3-□B1: 400VDC or more MR-J3-□B4: 800VDC or more 	<ul style="list-style-type: none"> Use the regenerative brake option. Correct the setting of the regenerative brake option (servo parameter). →Refer to Subsection 11.2.1 Change the regenerative brake option leads. Correctly connect the regenerative brake option leads. Replace the servo amplifier. For a wire break of the built-in regenerative brake resistor, change the servo amplifier. For a wire break of the regenerative brake option, change the regenerative brake option. Add the regenerative brake option or increase the capacity. Review the power supply Correct the wiring.
	2034 (34)	Receive error 1 • SSCNET III communication error (continuous communication error for about 3.5ms)	<ul style="list-style-type: none"> Connect after turning the control circuit power supply of the servo amplifier OFF. Wipe off any dirt from the end surface. Change the cable. Adopt noise suppression measures.
	2035 (35)	Command frequency error • The input pulse frequency of the command pulse is too high.	<ul style="list-style-type: none"> Review the operation program. Change the servo system controller. Adopt noise suppression measures on the I/O signals. Adopt noise suppression measures on the controller side.
	2036 (36)	Receive error 2 • SSCNET III communication error (intermittent communication error for about 70ms)	<ul style="list-style-type: none"> Connect after turning the control circuit power supply of the servo amplifier OFF. Wipe off any dirt from the end surface. Change the cable. Adopt noise suppression measures.
	2037 (37)	Parameter error • Parameter setting is wrong.	<ul style="list-style-type: none"> Set the parameter value within the setting range. Change the servo amplifier.
	2045 (45)	Main circuit device overheat • Main circuit device overheat	<ul style="list-style-type: none"> Replace the servo amplifier. Review the drive method. Review the environment so that the ambient temperature is within the range 0 to 55°C. Use within the specification range.
	2046 (46)	Servo motor overheat • A servo motor temperature rise actuated the thermal sensor.	<ul style="list-style-type: none"> Review the environment so that the ambient temperature is within the range 0 to 40°C. Reduce the load. Review the operation pattern. Use a servo motor that provides larger output. Replace the servo motor.

11 Buffer Memory

12 Program Example

13 Diagnostics

A List of Parameters and Data

B Version Information

Error category	Error Code (decimal)	Error Content	Action
Servo amplifier		Error code, error content and action are given for the MR-J3-□B(S).	
		Parentheses () in the error code column indicate the LED display of the MR-J3-□B(S).	
			→For the MR-J3W-□B, refer to the MR-J3W-□B Instruction Manual
			→For the MR-J4-□B, refer to the MR-J4-□B Instruction Manual
			→For the MR-J4W2-□B, refer to the MR-J4W2-□B Instruction Manual
		→For details on how to check errors and actions, refer to the manual of the servo amplifier to be connected	
2047 (47)	Cooling fan alarm • The cooling fan of the servo amplifier stopped. • The rotation speed of the fan fell below the alarm level.	<ul style="list-style-type: none"> • Replace the cooling fan of the servo amplifier. • Remove any debris • Replace the servo amplifier. 	
2050 (50)	Overload 1 The load exceeded the overload protection characteristics of the servo amplifier.	<ul style="list-style-type: none"> • The servo amplifier is exceeding its continuous output current rating. <ul style="list-style-type: none"> - Reduce the load. - Review the operation pattern. - Use a servo motor that provides larger output. • Machine collision occurred. <ul style="list-style-type: none"> - Review the operation pattern. - Install limit switches. • Connect the servo motor correctly. • Servo system is unstable due to servo hunting (jittering). <ul style="list-style-type: none"> - Repeat acceleration/deceleration to execute auto tuning. - Change the auto tuning response setting (servo parameter). <ul style="list-style-type: none"> →Refer to Subsection 11.2.1 - Set the auto tuning mode (servo parameter) to OFF and manually adjust the gain. <ul style="list-style-type: none"> →Refer to Subsection 11.2.1 • Replace the servo motor. 	
2051 (51)	Overload 2 • A machine collision or other similar factor has caused the max. output current to flow continuously for several seconds. Servo motor - Locked :1s or more - During rotation :2.5s or more	<ul style="list-style-type: none"> • Machine collision occurred. <ul style="list-style-type: none"> - Review the operation pattern. - Install limit switches. • Connect the servo motor correctly. • Hunting is occurring due to an unstable servo system. <ul style="list-style-type: none"> - Repeat acceleration/deceleration to execute auto tuning. - Change the auto tuning response setting (servo parameter). <ul style="list-style-type: none"> →Refer to Subsection 11.2.1 - Set the auto tuning mode (servo parameter) to OFF and manually adjust the gain. <ul style="list-style-type: none"> →Refer to Subsection 11.2.1 • Replace the servo motor. 	
2052 (52)	Excessive error The deviation between the model position and the actual servo motor position exceeds the excessive error alarm level (servo parameter) setting value (default: 3 rotations). →Refer to Subsection 11.2.3	<ul style="list-style-type: none"> • Increase the acceleration/deceleration time constant. • Increase the torque limit value. • The motor cannot be started due to insufficient torque caused by a power supply voltage drop. <ul style="list-style-type: none"> - Review the power supply capacity. - Use a servo motor with larger output. • Increase the value of model control gain (servo parameter) and adjust to ensure proper operation. <ul style="list-style-type: none"> →Refer to Subsection 11.2.2 • The servo motor shaft was rotated by an external force. <ul style="list-style-type: none"> - When the torque is limited, increase the limit value. - Reduce the load. - Use a servo motor with larger output. • Machine collision occurred. <ul style="list-style-type: none"> - Review the operation pattern. - Install limit switches. • Replace the servo motor. • Connect the servo motor correctly. • Replace the SSCNET III cable. 	

Error category	Error Code (decimal)	Error Content	Action
Servo amplifier	Error code, error content and action are given for the MR-J3-□B(S). Parentheses () in the error code column indicate the LED display of the MR-J3-□B(S). →For the MR-J3W-□B, refer to the MR-J3W-□B Instruction Manual →For the MR-J4-□B, refer to the MR-J4-□B Instruction Manual →For the MR-J4W2-□B, refer to the MR-J4W2-□B Instruction Manual →For details on how to check errors and actions, refer to the manual of the servo amplifier to be connected		
	2056 (56)	Forced stop error (Only the MR-J3-□BS and MR-J4(W2)-□B) The servo motor does not decelerate normally during forced stop deceleration.	<ul style="list-style-type: none"> Increase the forced stop deceleration command time constant. The servo motor shaft was rotated by an external force. <ul style="list-style-type: none"> When the torque is limited, increase the limit value. Reduce the load. Use a servo motor with larger output. Connect the servo motor properly. Replace the servo motor.
	2060 (1A)	Motor combination error <ul style="list-style-type: none"> Wrong combination of servo amplifier and servo motor 	Select the correct combination.
	2063 (63)	STO timing error (Only the MR-J3-□BS and MR-J4(W2)-□B) STO signal turns off while the servo motor is rotating.	<ul style="list-style-type: none"> Check the external sequence if the condition which turns off the STO signal is appropriate. Check STO delay time setting (rotary switch) of MR-J3-D05. Be sure to consult with a machine builder when changing the delay time setting.
	2922 (3E)	Operation mode error (Only the MR-J4(W2)-□B) <ul style="list-style-type: none"> Wrong operation mode setting. 	<ul style="list-style-type: none"> Return the servo amplifier to factory default settings using the application "MR-J4(W)-B mode selection" attached to MR Configurator2, and then connect the servo amplifier again to the controller. Correct the setting of the servo parameter "PA01".
	2088 (888)	Watchdog <ul style="list-style-type: none"> CPU/part fault 	The servo amplifier must be repaired. Consult your local Mitsubishi Electric representative.

13.2.4 Servo warning list [BFM #68 (X-axis), BFM #168 (Y-axis)]

The warning detected by the servo amplifier is stored.
Remove the cause of the warning.

Additionally, this manual describes servo warning codes when connecting the MR-J3-□B(S).

- For details on warnings, refer to the manual of the servo amplifier to be connected
- For details on warnings of the MR-J3W-□B, refer to the MR-J3W-□B Instruction Manual
- For details on warnings of the MR-J4-□B, refer to the MR-J4-□B Instruction Manual
- For details on warnings of the MR-J4W2-□B, refer to the MR-J4W2-□B Instruction Manual

1. State when a warning code occurs

Warning code	Servo amplifier LED indication	Name	State when a warning occurs	
			Servo amplifier	20SSC-H
2095	95	STO warning (Only the MR-J3-□BS and MR-J4(W2)-□B)	Servo OFF	Operation is stopped (An error has occurred)
2102	92	Open battery cable warning	Servo ON is continued	Operation is continued
2106	96	Home position setting warning		
2116	9F	Battery warning		
2140	E0	Excessive regenerative warning		
2141	E1	Overload warning 1		Operation is continued warning (zero return completed: OFF)
2143	E3	Absolute position counter warning		
2144	E4	Parameter warning		
2146	E6	Servo forced stop warning	Servo OFF	Operation is stopped (An error has occurred)
2147	E7	Controller forced stop warning	Servo ON is continued	Operation is continued
2148	E8	Cooling fan speed reduction warning		
2149	E9	Main circuit OFF warning		
2152	EC	Overload warning 2		
2153	ED	Output watt excess warning		

11 Buffer Memory

12 Program Example

13 Diagnostics

A List of Parameters and Data

B Version Information

2. Content of warning and action

20SSC-H warning code	Servo amplifier LED indication	Content	Action
2095	95	STO warning (Only the MR-J3-□BS and MR-J4(W2)-□B) STO I/O signal turns off.	<ul style="list-style-type: none"> • Properly connect the STO I/O signal connector. • Change the STO cable. • Change MR-J3-D05. • Change the external device, or review the setting.
2102	92	Open battery cable warning The absolute position detection system battery voltage is low.	Replace the servo amplifier battery.
2106	96	Home position setting warning The zero return could not be set to the accurate position.	<ul style="list-style-type: none"> • Remove the cause of drop pulses. • Reduce the creep speed.
2116	9F	Battery warning The voltage of the battery for the absolute position detection system is low.	Replace the servo amplifier battery.
2140	E0	Excessive regenerative warning There is a possibility that regenerative power may exceed the permissible regenerative power of the built-in regenerative brake resistor or the regenerative brake option.	<ul style="list-style-type: none"> • Reduce the frequency of positioning. • Change the regenerative brake option to the one with a larger capacity. • Reduce the load.
2141	E1	Overload warning There is a possibility that overload (error code: 2050) or overload (error code: 2051) may occur.	Refer to the manual of the servo amplifier.
2143	E3	Absolute position counter warning Absolute position encoder pulses are faulty.	<ul style="list-style-type: none"> • To reduce the noise, follow the servo amplifier manual. • Replace the servo motor.
2144	E4	Parameter warning Parameters are outside the setting range.	Set the servo parameters correctly.
2146	E6	Servo forced stop warning Servo amplifier input signal EM1 is OFF.	Ensure safety and deactivate the forced stop.
2147	E7	A watchdog error occurred on the 20SSC-H.	If this error occurs after rebooting and initializing the 20SSC-H, the module needs repair. Consult your local Mitsubishi Electric representative.
2148	E8	Cooling fan speed reduction warning The rotation speed of the servo amplifier's cooling fan fell below the warning level. *1	<ul style="list-style-type: none"> • Replace the cooling fan of the servo amplifier. • Replace the servo amplifier.
2149	E9	Main circuit OFF warning The servo ON signal turned ON with the main circuit power OFF.	Turn the main circuit power ON.
2152	EC	Overload warning 2 Operation in which a current exceeding the rating flow intensity in any of the U, V or W phases of the servo motor, is repeated.	<ul style="list-style-type: none"> • Reduce the positioning frequency at the specific positioning address. • Reduce the load. • Exchange the servo amplifier/servo motor with one of a larger capacity.
2153	ED	Output watt excess warning The status in which the output wattage (speed × torque) of the servo motor exceeds the rated output.	<ul style="list-style-type: none"> • Reduce the rotation speed of the servo motor. • Reduce the load.

*1. This warning is not displayed on MR-J3-70B(S)/100B(S) servo amplifiers with cooling fans.

13.3 Diagnostics on the PLC Main Unit

The following describes some of the PLC errors from the LED lights on the PLC.

For details related to the PLC main unit wiring, special auxiliary relays, and special data registers, refer to the following respective manuals.

→ **FX3U Hardware Edition**

→ **FX3UC Hardware Edition**

13.3.1 POWER LED [on/flashing/off]

LED state	PLC state	Action
On	Power of the specified voltage is being supplied to the power supply terminal.	The power supply is normal.
Flashing	One of the following causes may have occurred: <ul style="list-style-type: none"> Power and current of the specified voltage is not being supplied to the power supply terminal. Incorrect external wiring. Internal errors in the PLC. 	<ul style="list-style-type: none"> Check the supply voltage. After disconnecting cables other than the power cable, turn the power ON again, and check for changes in the state. If no improvement is obtained, Consult your local Mitsubishi Electric representative.
Off	One of the following causes may have occurred: <ul style="list-style-type: none"> The power supply is OFF. Incorrect external wiring. Power of the specified voltage is not being supplied to the power supply terminal. The power cable is broken. 	<ul style="list-style-type: none"> If the power is not OFF, check the power supply and the power supply route. If power is being supplied correctly, consult your local Mitsubishi Electric representative. After disconnecting cables other than the power cable, turn the power ON again, and check for changes in the state. If no improvement is obtained, Consult your local Mitsubishi Electric representative.

13.3.2 BATT LED [on/off]

LED state	PLC state	Action
On	The battery voltage is low.	Immediately replace the battery.
Off	The battery voltage is higher than the value with D8006.	Normal

11

Buffer Memory

12

Program Example

13

Diagnostics

A

List of Parameters and Data

B

Version Information

13.3.3 ERROR LED [on/flashing/off]

LED state	PLC state	Action
On	A watchdog timer error may have occurred, or the hardware of the PLC may be damaged.	<ol style="list-style-type: none"> 1) Stop the PLC, and turn the power ON again. If the ERROR LED goes out, a watchdog timer error may have occurred. Adopt any of the following measures: <ul style="list-style-type: none"> - Review the program. Set the maximum value (D8012) lower than the watchdog timer value. - Check that the input used for input interrupt or pulse catch is not being abnormally turned ON and OFF in one scan. - Check that the frequency of the pulse (duty 50%) input to the high-speed counter is not exceeding the specified range. - Add WDT instructions. Add some WDT instructions to the program, and reset the watchdog timer several times in one scan. - Change the watchdog timer value. Change the watchdog timer setting (D8000) in the program so that the setting is larger than the maximum value of the scan time (D8012). 2) Remove the PLC and supply the power to it from another power source. If the ERROR LED goes out, noise may have affected the PLC. Adopt the following measures: <ul style="list-style-type: none"> - Check the ground wiring, and re-examine the wiring route and installation location. - Fit a noise filter onto the power supply line. 3) If the ERROR LED does not go out even after measures in 1) and 2) are adopted, consult your local Mitsubishi Electric representative.
Flashing	One of the following errors has occurred on the PLC: <ul style="list-style-type: none"> • Parameter error • Syntax error • Ladder error 	Perform PLC diagnosis and program check with the programming tool.
Off	No errors to stop the PLC have occurred.	If the operations of the PLC are abnormal, perform PLC diagnosis and program check with the programming tool. An I/O error, parallel link/communication error, or operation error may have occurred.

Appendix A: LIST OF PARAMETERS AND DATA

Appendix A-1 Monitor Data List

BFM Number		Item	Description	Value of monitor	Default value	Reference
X axis	Y axis					
BFM #1,#0	BFM #101,#100	Current address (user)	-2,147,483,648 to 2,147,483, 647 (user unit) *1	Decimal	-	Subsection 11.3.1
BFM #3,#2	BFM #103,#102	Current address (pulse)	-2,147,483,648 to 2,147,483,647 PLS	Decimal	-	Subsection 11.3.2
BFM #5,#4	BFM #105,#104	Torque limit storing value	1 to 10000($\times 0.1\%$)	Decimal	-	Subsection 11.3.3
BFM #6	BFM #106	Error BFM number	Stores error BFM number	Decimal	-	Subsection 11.3.4
BFM #7	BFM #107	Terminal information	b0 START terminal input: ON b1 DOG terminal input: ON b2 INT0 terminal input: ON b3 INT1 terminal input: ON b4 ϕA terminal input: ON b5 ϕB terminal input: ON b15 to b6 Not available	Bit	-	Subsection 11.3.5
BFM #8	BFM #108	Servo terminal information	b0 FLS terminal input: ON b1 RLS terminal input: ON b2 DOG terminal input: ON b15 to b3 Not available	Bit	-	Subsection 11.3.6
BFM #9	BFM #109	m code number	Stores m code number which is ON.	Decimal	-	Subsection 11.3.7
BFM #11,#10	BFM #111,#110	Operation speed present value	0 to 2,147,483,647(user unit) *1	Decimal	-	Subsection 11.3.8
BFM #13,#12	BFM #113,#112	Manual pulse generator input current value	-2,147,483,648 to 2,147,483,647 PLS	Decimal	-	Subsection 11.3.9
BFM #15,#14	BFM #115,#114	Manual pulse generator input frequency	-100000 to 100000Hz	Decimal	-	Subsection 11.3.10
BFM #16	BFM #116	Number of the table in operation	Stores the number of the table in operation	Decimal	-	Subsection 11.3.11
BFM #17	-	Version information	Example: In Ver.1.00, K100 is stored.	Decimal	-	Subsection 11.3.12
BFM #21,#20	BFM #121,#120	Real current address (User) (Ver.1.20 or later)	-2,147,483,648 to 2,147,483,647(user unit) *1	Decimal	-	Subsection 11.3.13
BFM #23,#22	BFM #123,#122	Real current address (Pulse) (Ver.1.20 or later)	-2,147,483,648 to 2,147,483,647 PLS	Decimal	-	Subsection 11.3.14
BFM #25,#24	BFM #125,#124	Received target address (Ver.1.20 or later)*2	-2,147,483,648 to 2,147,483,647(user unit) *1	Decimal	-	Subsection 11.3.15
BFM #27,#26	BFM #127,#126	Received target speed (Ver.1.20 or later)	-2,147,483,648 to 2,147,483,647(user unit) *1	Decimal	-	Subsection 11.3.16
BFM #28	BFM #128	Status information	b0 READY/BUSY b1 During forward rotation pulse output b2 During reverse rotation pulse output b3 Zero return completed b4 Current value overflow b5 Error occurrence b6 Positioning control completion b7 Standby for remaining travel distance at stop b8 m code is ON b9 Unit ready b10 During servo parameter transfer b11 Saving to flash memory*3 b12 Initializing buffer memory*3 b13 During operation speed change b14 During target address change b15 During table operation execution	Bit	-	Subsection 11.3.17

BFM Number		Item	Description	Value of monitor	Default value	Reference
X axis	Y axis					
BFM #29	BFM #129	Error code	Stores the error code	Decimal	-	Subsection 11.3.18
BFM #30	-	Model code	Stores the model code of 20SSC-H	Decimal	K5220	Subsection 11.3.19
BFM #32	BFM #132	Status information 2 (Ver.1.20 or later)	b0 Positioning parameter change completion flag b15 to b1 Not available	Bit	-	Subsection 11.3.20
BFM #35, #34	BFM #135, #134	Current address when an interrupt occurs (INT0) ^{*4} (Ver.1.30 or later)	-2,147,483,648 to 2,147,483, 647 (user unit) ^{*1}	Decimal	-	Subsection 11.3.21
BFM #37, #36	BFM #137, #136	Current address when an interrupt occurs (INT1) ^{*4} (Ver.1.30 or later)	-2,147,483,648 to 2,147,483, 647 (user unit) ^{*1}	Decimal	-	Subsection 11.3.21
BFM #51, #50	BFM #151, #150	Deviation counter value	Deviation counter value of servo amplifier (PLS)	Decimal	-	Subsection 11.3.22
BFM #53, #52	BFM #153, #152	Motor rotation speed	Rotation speed of servo motor ($\times 0.1$ r/min.)	Decimal	-	Subsection 11.3.23
BFM #54	BFM #154	Motor current value	Current value of servo motor ($\times 0.1\%$)	Decimal	-	Subsection 11.3.24
BFM #61 to #56	BFM #161 to #156	Software number of servo amplifier	Stores software number of servo amplifier	ASCII code	-	Subsection 11.3.25
BFM #62	BFM #162	Servo parameter error number	Stores parameter number of servo parameter	Decimal	-	Subsection 11.3.26
BFM #63	BFM #163	Servo status	b0 Zero phase passed b2,b1 Not available b3 Zero speed b15 to b4 Not available	Bit	-	Subsection 11.3.27
BFM #64	BFM #164		b0 Ready ON b1 Servo ON b6 to b2 Not available b7 Servo alarm is arising b11 to b8 Not available b12 In-position b13 Torque is limited b14 Absolute position is lost b15 Warning is arising	Bit	-	Subsection 11.3.27
BFM #65	BFM #165	Regenerative load ratio	Regenerative load ratio(%)	Decimal	-	Subsection 11.3.28
BFM #66	BFM #166	Effective load torque	Effective load torque (%)	Decimal	-	Subsection 11.3.29
BFM #67	BFM #167	Peak torque ratio	Peak torque ratio (%)	Decimal	-	Subsection 11.3.30
BFM #68	BFM #168	Servo warning Code	Stores servo warning number	Decimal	-	Subsection 11.3.31
BFM #71, #70	BFM #171, #170	Motor feedback position	Motor feedback position (PLS)	Decimal	-	Subsection 11.3.32
BFM #72	BFM #172	Servo status 2	b0 Flag indicating parameter update is completed b1 Parameter updating flag b2 Parameter update request flag b15 to b3 Not available	Bit	-	Subsection 11.3.33
BFM #91, #90	-	Flash memory write count	Number of writing to flash memory (max:100,000 times)	Decimal	-	Subsection 11.3.34

*1. For details on the user units, refer to the section given below.

→ Refer to Section 7.10

*2. Variable speed operation is not supported.

*3. BFM #128 b11 and b12 are not available.

*4. The error in the calculation of user units is included in the value of the current address when an interrupt occurs.

Appendix A-2 Control Data Table

BFM number		Item	Description/Setting range	Default value	Reference
X axis	Y axis				
BFM #501,#500	BFM #601,#600	Target address1	-2,147,483,648 to 2,147,483,647 (user unit) *1	K0	Subsection 11.4.1
BFM #503,#502	BFM #603,#602	Operation speed1	1 to 2,147,483,647 (user unit) *1 *2	K1	Subsection 11.4.2
BFM #505,#504	BFM #605,#604	Target address2	-2,147,483,648 to 2,147,483,647 (user unit) *1	K0	Subsection 11.4.3
BFM #507,#506	BFM #607,#606	Operation speed2	1 to 2,147,483,647 (user unit) *1 *2	K1	Subsection 11.4.4
BFM #508	BFM #608	Override setting	1 to 30000 (×0.1%)	K1000	Subsection 11.4.5
BFM #510	BFM #610	Torque output setting value	0 to 10000 (×0.1%)	K0	Subsection 11.4.6
BFM #513,#512	BFM #613,#612	Speed change value	1 to 2,147,483,647 (user unit) *1 *2	K1	Subsection 11.4.7
BFM #515,#514	BFM #615,#614	Target position change value (address)	-2,147,483,648 to 2,147,483,647 (user unit) *1	K0	Subsection 11.4.8
BFM #517,#516	BFM #617,#616	Target position change value (speed)	1 to 2,147,483,647 (user unit) *1	K0	Subsection 11.4.9
BFM #518	BFM #618	Operation command 1	b0 Error reset b1 STOP (Deceleration stop) b2 Forward rotation limit (LSF) b3 Reverse rotation limit (LSR) b4 Forward rotation JOG b5 Reverse rotation JOG b6 Mechanical zero return command b7 Not available b8 Relative/absolute address specification b9 START command b10 Simultaneous START flag *3 b11 m code OFF b12 Change command in operation disabled b13 Speed change command in positioning operation b14 Target position change command in positioning operation b15 Not available	H0000	Subsection 11.4.10
BFM #519	BFM #619	Operation command 2	b0 Remaining distance operation cancel command b1 System reset command (Ver.1.10 or later) *4 b3, b2 Not available b4 Positioning parameter enable command b5 Acceleration/deceleration time change command (Ver.1.30 or later) b6 Mode selection for the Interrupt 1-speed constant quantity feed (Ver.1.10 or later) b7 Interrupt 1-speed Constant Quantity Feed (Constant position stop mode) shortest allowable stop (Ver.1.30 or later) b8 Servo OFF command b9 Servo parameter transfer command b10 Gain change command b11 Servo parameter update stop (Ver.1.10 or later) b15 to b12 Not available	H0000	Subsection 11.4.11
BFM #520	BFM #620	Operation pattern selection	b0 1-speed positioning b1 Interrupt 1-speed constant quantity feed b2 2-speed positioning b3 Interrupt 2-speed constant quantity feed b4 Interrupt stop b5 Variable speed operation b6 Manual pulse generator operation b7 Linear interpolation b8 Linear interpolation (interrupt stop) b9 Table operation (individual) b10 Table operation (simultaneous) b11 Reciprocal movement instruction (Ver.1.10 or later) b15 to b12 Not available	H0000	Subsection 11.4.12

11

Buffer Memory

12

Program Example

13

Diagnostics

A

List of Parameters and Data

B

Version Information

BFM number		Item	Description/Setting range	Default value	Reference
X axis	Y axis				
BFM #521	BFM #621	Table operation start number	0 to 299	K0	Subsection 11.4.13
BFM #522		Control command enable/disable	Model code: control command enabled Other than model code: control command disabled	K0	Subsection 11.4.14
BFM #523		Control command	b0 Stores positioning parameters of X axis (BFM#14000 to BFM #14199) to flash memory b1 Stores positioning parameters of Y axis(BFM#14200 to BFM #14399) to flash memory b2 Stores table information of X axis (BFM #1000 to BFM #3999) to flash memory b3 Stores table information of Y axis (BFM #4000 to BFM #6999) to flash memory b4 Stores table information of XY axes (BFM #7000 to BFM #12999) to flash memory b5 Stores servo parameters of X axis (BFM #15000 to BFM #15199) to flash memory b6 Stores servo parameters of Y axis (BFM #15200 to BFM #15399) to flash memory b7 Not available b8 Initializes positioning parameters of X axis (BFM #14000 to BFM #14199) b9 Initializes positioning parameters of Y axis (BFM #14200 to BFM #14399) b10 Initializes table information of X axis (BFM #1000 to BFM #3999) b11 Initializes table information of Y axis (BFM #4000 to BFM #6999) b12 Initializes table information of XY axes (BFM #7000 to BFM #12999) b13 Initializes servo parameters of X axis (BFM #15000 to BFM #15199) b14 Initializes servo parameters of Y axis (BFM #15200 to BFM #15399) b15 Not available	H0000	Subsection 11.4.15
BFM #525,#524	BFM #625,#624	Manual pulse input magnification (numerator)	1 to 1,000,000 times	K1	Subsection 11.4.16
BFM #527,#526	BFM #627,#626	Manual pulse input magnification (denominator)	1 to 1,000,000 times	K1	Subsection 11.4.17
BFM #528	BFM #628	MPG response (Ver. 1.10 or later)	1 to 32767	K4	Subsection 11.4.18
BFM #529		MPG input selection (Ver. 1.10 or later)	0: X input - X opr / Y input - Y opr 1: X input - Y opr 2: X input - X and Y opr	K0	Subsection 11.4.19
BFM #530	BFM #630	Ring operation rotation direction for absolute address (Ver. 1.10 or later)	0: Direction for shorter rotation 1: Direction where the current value increases (clockwise) 2: Direction where the current value decreases (counterclockwise)	K0	Subsection 11.4.20

*1. For details on the user units, refer to the section given below.

→ Refer to Section 7.10

*2. -2,147,483,648 to 2,147,483,647 with Variable Speed operation.

*3. BFM #618 b10 is not available.

*4. BFM #619 b1 is not available.

Appendix A-3 Table Information List

BFM number			Table number	Item	Description/Setting range	Default value	Reference	
X axis	Y axis	XY axis						
BFM #1001,#1000	-	BFM #7001,#7000	0	Position data x	Positioning: -2,147,483,648 to 2,147,483,647 (user unit) * ¹ Present address changing: -2,147,483,648 to 2,147,483,647 (user unit) * ¹ Dwell: 0 to 32,767 (×10ms) Jump: 0 to 299	K-1	Section 11.5	
-	BFM #4001,#4000	BFM #7003,#7002		Position data y		K-1		
BFM #1003,#1002	-	BFM #7005,#7004		Speed data x		1 to 50,000,000 (user unit) * ¹		K-1
-	BFM #4003,#4002	BFM #7007,#7006		Speed data y				K-1
-	-	BFM #7009,#7008		Center coordinate i, radius r		-2,147,483,648 to 2,147,483,647 (user unit) * ¹		K-1
-	-	BFM #7011,#7010		Center coordinate j				K-1
BFM #1004	BFM #4004	BFM #7012		Operation information		Sets operation/command (-1 to 99) * ²		K-1
BFM #1005	BFM #4005	BFM #7013		m code information		Stores m code in execution		K-1
BFM #1011,#1010	-	BFM #7021,#7020		1		Position data x		Same as table number 0
-	BFM #4011,#4010	BFM #7023,#7022	Position data y		K-1			
BFM #1013,#1012	-	BFM #7025,#7024	Speed data x		K-1			
-	BFM #4013,#4012	BFM #7027,#7026	Speed data y		K-1			
-	-	BFM #7029,#7028	Center coordinate i, radius r		K-1			
-	-	BFM #7031,#7030	Center coordinate j		K-1			
BFM #1014	BFM #4014	BFM #7032	Operation information		K-1			
BFM #1015	BFM #4015	BFM #7033	m code information		K-1			
:	:	:	:		:	:	:	
BFM #3991,#3990	-	BFM #12981,#12980	299	Position data x	Same as table number 0	K-1		
-	BFM #6991,#6990	BFM #12983,#12982		Position data y		K-1		
BFM #3993,#3992	-	BFM #12985,#12984		Speed data x		K-1		
-	BFM #6993,#6992	BFM #12987,#12986		Speed data y		K-1		
-	-	BFM #12989,#12988		Center coordinate i, radius r		K-1		
-	-	BFM #12991,#12990		Center coordinate j		K-1		
BFM #3994	BFM #6994	BFM #12992		Operation information		K-1		
BFM #3995	BFM #6995	BFM #12993		m code information		K-1		

*1. For details on the user units, refer to the section given below.

→ Refer to Section 7.10

*2. The operation information includes the following items.

- | | |
|--|---|
| -1: No processing (NOP) | 19: Linear interpolation (LIN) |
| -1: m code (NOP) | 20: Linear interpolation (interrupt stop) (LIN_INT) |
| 0: End (END) | 21: Circular interpolation (center, CW direction)(CW_i) |
| 1: 1-speed positioning (DRV_X) | 22: Circular interpolation
(center, CCW direction) (CCW_i) |
| 2: 1-speed positioning (DRV_Y) | 23: Circular interpolation (radius, CW direction) (CW_r) |
| 2: 1-speed positioning (DRV_XY) | 24: Circular interpolation
(radius, CCW direction) (CCW_r) |
| 4: Interrupt 1-speed constant quantity feed (SINT_X) | 25: Mechanical zero return operation (DRVZ_X) |
| 5: Interrupt 1-speed constant quantity feed (SINT_Y) | 26: Mechanical zero return operation (DRVZ_Y) |
| 6: Interrupt 1-speed constant quantity feed (SINT_XY) | 27: Mechanical zero return operation (DRVZ_XY) |
| 7: 2-speed positioning (DRV2_X) | 90: Current address change (SET_X) |
| 8: 2-speed positioning (DRV2_Y) | 91: Current address change (SET_Y) |
| 9: 2-speed positioning (DRV2_XY) | 92: Current address change (SET_XY) |
| 10: Interrupt 2-speed constant quantity feed (DINT_X) | 93: Absolute address specification (ABS) |
| 11: Interrupt 2-speed constant quantity feed (DINT_Y) | 94: Relative address specification (INC) |
| 12: Interrupt 2-speed constant quantity feed (DINT_XY) | 95: Dwell (TIM) |
| 13: Interrupt stop (INT_X) | 96: Jump (JMP) |
| 14: Interrupt stop (INT_Y) | |
| 15: Interrupt stop (INT_XY) | |
| 16: Multi speed operation (DRVC_X) | |
| 17: Multi speed operation (DRVC_Y) | |

Appendix A-4 Positioning parameters List

BFM number		Item	Description/Setting range	Default value	Reference
X axis	Y axis				
BFM #14000	BFM #14200	Operation parameter 1	b1,b0 System of units (user unit) ^{*1} (motor, mechanical, composite system) b3,b2 Unit of measurement for the user units (μm , Ccm/min, 10^{-4}inch , inch/min, mdeg, 10deg/min) b5,b4 Position data magnification (1 to 1000 times) b9 to b6 Not available b10 Zero return direction b11 Acceleration/deceleration mode b12 DOG input logic b13 Zero-phase signal count start timing b14 Not available b15 STOP mode	H0000	Subsection 11.1.1
BFM #14002	BFM #14202	Operation parameter 2	b0 Servo end check enabled/disabled b1 Servo ready check enabled/disabled b2 Zero return interlock setting enabled/disabled b3 Ring counter setting (Ver. 1.10 or later) b4 Sudden stop selection (STOP command) sudden stop / Normal deceleration stop (Ver.1.20 or later) b5 Sudden stop selection (software limit) sudden stop / Normal deceleration stop (Ver.1.20 or later) b6 Sudden stop selection (PLC limit) sudden stop / Normal deceleration stop (Ver.1.20 or later) b7 Sudden stop selection (Servo amplifier limit) sudden stop / Normal deceleration stop (Ver.1.20 or later) b8 Servo startup ON/OFF selection (Ver.1.30 or later) b13 to b9 Not available b14 Interpolation gear ratio selection (Ver. 1.20 or later) ^{*2} b15 BFM servo parameter transfer mode (Ver. 1.10 or later)	H0007	Subsection 11.1.2
BFM #14005, #14004	BFM #14205, #14204	Pulse rate	1 to 200,000,000 PLS/REV	K262,144	Subsection 11.1.3
BFM #14007, #14006	BFM #14207, #14206	Feed rate	1 to 200,000,000 ($\mu\text{m}/\text{REV}$, $10^{-4}\text{inch}/\text{REV}$, mdeg/REV)	K52,428,800	Subsection 11.1.4
BFM #14009, #14008	BFM #14209, #14208	Maximum speed	1 to 2,147,483,647 (user unit) ^{*1}	K4,000,000	Subsection 11.1.5
BFM #14013, #14012	BFM #14213, #14212	JOG speed	1 to 2,147,483,647 (user unit) ^{*1}	K2,000,000	Subsection 11.1.6
BFM #14014	BFM #14214	JOG command determination time	0 to 5000 ms	K300	Subsection 11.1.7
BFM #14018	BFM #14218	Acceleration time	1 to 5000 ms	K200	Subsection 11.1.8
BFM #14020	BFM #14220	Deceleration time	1 to 5000 ms	K200	Subsection 11.1.9
BFM #14022	BFM #14222	Interpolation time constant	1 to 5000 ms	K100	Subsection 11.1.10
BFM #14025, #14024	BFM #14225, #14224	Zero return speed (high speed)	1 to 2,147,483,647 (user unit) ^{*1}	K4,000,000	Subsection 11.1.11
BFM #14027, #14026	BFM #14227, #14226	Zero return speed (creep)	1 to 2,147,483,647 (user unit) ^{*1}	K100,000	Subsection 11.1.12
BFM #14029, #14028	BFM #14229, #14228	Mechanical zero-point address	-2,147,483,648 to 2,147,483,647 (user unit) ^{*1}	K0	Subsection 11.1.13

11

Buffer Memory

12

Program Example

13

Diagnostics

A

List of Parameters and Data

B

Version Information

BFM number		Item	Description/Setting range	Default value	Reference
X axis	Y axis				
BFM #14030	BFM #14230	Zero signal count	0 to 32767 PLS	K1	Subsection 11.1.14
BFM #14031	BFM #14231	Zero return mode	Selects zero return mode 0 DOG 1 Data set type 2 Stopper (1) 3 Stopper (2)	K0	Subsection 11.1.15
BFM #14032	BFM #14232	Servo end evaluation time	1 to 5000 ms	K5000	Subsection 11.1.16
BFM #14035, #14034	BFM #14235, #14234	Software limit (upper)	Sets upper limit of software limit -2,147,483,648 to 2,147,483,647 (user unit) *1	K0	Subsection 11.1.17
BFM #14037, #14036	BFM #14237, #14236	Software limit (lower)	Sets lower limit of software limit -2,147,483,648 to 2,147,483,647 (user unit) *1	K0	
BFM #14038	BFM #14238	Torque limit value	1 to 10000(×0.1%)	K3000	Subsection 11.1.18
BFM #14040	BFM #14240	Zero return torque limit value	1 to 10000(×0.1%)	K3000	Subsection 11.1.19
BFM #14044	BFM #14244	External input selection	b0 Use/ not use FLS, RLS signal servo amplifier b1 Use/ not use DOG signal of servo amplifier b7 to b2 Not available b8 FLS/RLS signal logic of servo amplifier b9 DOG signal logic of servo amplifier b15 to b10 Not available	H0100	Subsection 11.1.20
BFM #14101, #14100	BFM #14301, #14300	Ring counter upper limit value (Ver. 1.10 or later)	Sets the ring counter upper limit value 1 to 359,999,999 (user unit) *1	K359,999	Subsection 11.1.21
BFM #14102	BFM #14302	Sudden stop deceleration time (Ver. 1.20 or later)	Sets the sudden stop deceleration time 1 to 5000 ms	K100	Subsection 11.1.22
BFM #14104	BFM #14304	Sudden stop interpolation time constant (Ver. 1.20 or later)	Sets the sudden stop interpolation time constant 1 to 5000 ms	K80	Subsection 11.1.23
BFM #14106	BFM #14306	Positioning completion signal output waiting time (Ver. 1.20 or later)	Sets the positioning completion signal output waiting time 0 to 5000 ms	K0	Subsection 11.1.24
BFM #14108	BFM #14308	Acceleration time 2 (Ver. 1.30 or later)	1 to 5000 ms	K200	Subsection 11.1.25
BFM #14110	BFM #14310	Deceleration time 2 (Ver. 1.30 or later)	1 to 5000 ms	K200	Subsection 11.1.26

*1. For details on the user units, refer to the section given below.

→ Refer to Section 7.10

*2. BFM # 14202 (b14) is not available.

Appendix A-5 Servo Parameters List

BFM number		Item	Settings	Default value	Reference
X axis	Y axis				
BFM #15000	BFM #15200	Servo amplifier series	Setting of servo amplifier series connected to 20SSC-H	K0	Subsection 11.2.1
BFM #15001	BFM #15201	Control mode (Ver. 1.40 or later)	Selects the control loop composition	H0000	
BFM #15002	BFM #15202	Regeneration option	Setting of with/without regeneration option	H0000	
BFM #15003	BFM #15203	Absolute position detection system	Setting of with/without absolute detection system	H0000	
BFM #15004	BFM #15204	Selecting functions A-1	<p>In the MR-J3(W)-□B Setting of with/without emergency stop input (EM1) to servo amplifier</p> <p>In the MR-J3-□BS (Ver. 1.40 or later) Setting of with/without emergency stop input (EM1/EM2) to servo amplifier</p> <p>In the MR-J4(W2)-□B Selection of forced stop input and forced stop deceleration function</p>	H0000	Subsection 11.2.2
BFM #15008	BFM #15208	Auto tuning mode	Setting of gain adjustment	H0001	
BFM #15009	BFM #15209	Auto tuning response	Setting of auto tuning response (low to high)	K12	
BFM #15010	BFM #15210	In-position range	0 to 65535 PLS	K100	
BFM #15014	BFM #15214	Rotation direction selection	Setting of rotation direction (CCW/CW) when viewed from the servo motor load	K0	
BFM #15015	BFM #15215	Encoder output pulses	1 to 65535 PLS/REV	K4000	
BFM #15019	BFM #15219	Adaptive tuning mode (Adaptive filter 2)	Setting of adaptive filter tuning	K0	
BFM #15020	BFM #15220	Vibration suppression control tuning mode (advanced vibration suppression control)	Setting of vibration suppression control tuning mode	K0	
BFM #15022	BFM #15222	Feed forward Gain	0 to 100 %	K0	
BFM #15024	BFM #15224	Ratio of load inertia moment to servo motor inertia moment	0 to 3000 (×0.1 time)	K70	
BFM #15025	BFM #15225	Model loop gain	1 to 2000 rad/s	K24	
BFM #15026	BFM #15226	Position loop gain	1 to 1000 rad/s	K37	
BFM #15027	BFM #15227	Speed loop gain	20 to 50000 rad/s	K823	
BFM #15028	BFM #15228	Speed integral compensation	1 to 10000 (×0.1ms)	K337	
BFM #15029	BFM #15229	Speed differential compensation	0 to 1000	K980	
BFM #15030	BFM #15230	Overshoot amount compensation (Ver. 1.40 or later)	0 to 100 %	K0	
BFM #15031	BFM #15231	Machine resonance suppression filter 1	100 to 4500 Hz	K4500	
BFM #15032	BFM #15232	Notch shape selection 1	Setting of notch form (depth, width)	H0000	
BFM #15033	BFM #15233	Machine resonance suppression filter 2	100 to 4500 Hz	K4500	
BFM #15034	BFM #15234	Notch shape selection 2	Settings of validity for machine resonance suppression filter 2 and notch shape (depth, width of notch)	H0000	
BFM #15036	BFM #15236	Low-pass filter	100 to 18000 rad/s	K3141	

11

Buffer Memory

12

Program Example

13

Diagnostics

A

List of Parameters and Data

B

Version Information

BFM number		Item	Settings	Default value	Reference
X axis	Y axis				
BFM #15037	BFM #15237	Vibration suppression Vibration frequency setting	1 to 1000 ($\times 0.1\text{Hz}$)	K1000	Subsection 11.2.2
BFM #15038	BFM #15238	Vibration suppression Resonance frequency setting	1 to 1000($\times 0.1\text{Hz}$)	K1000	
BFM #15041	BFM #15241	Low-pass filter selection	Selects setting method (auto/manual) of low-pass filter	H0000	
BFM #15042	BFM #15242	Slight vibration suppression control selection	Selects slight vibration suppression control (validity of the function, PI-PID switching method)	H0000	
BFM #15044	BFM #15244	Gain changing selection	Setting of the selection/condition for gain changing	H0000	
BFM #15045	BFM #15245	Gain changing condition	0 to 9999 (kpps, PLS, r/min)	K10	
BFM #15046	BFM #15246	Gain changing time constant	0 to 100 ms	K1	
BFM #15047	BFM #15247	Gain changing Ratio of load inertia moment to servo motor inertia moment	0 to 3000 ($\times 0.1$ time)	K70	
BFM #15048	BFM #15248	Gain changing Position loop gain	1 to 2000 rad/s	K37	
BFM #15049	BFM #15249	Gain changing Speed loop gain	20 to 50000 rad/s	K823	
BFM #15050	BFM #15250	Gain changing Speed integral compensation	1 to 50000 ($\times 0.1\text{ms}$)	K337	
BFM #15051	BFM #15251	Gain changing Vibration suppression control Vibration frequency setting	1 to 1000 ($\times 0.1\text{Hz}$)	K1000	
BFM #15052	BFM #15252	Gain changing Vibration suppression control Resonance frequency setting	1 to 1000 ($\times 0.1\text{Hz}$)	K1000	
BFM #15063	BFM #15263	Vibration suppression control filter 2 (Ver. 1.40 or later)	Selects the vibration suppression control filter 2 setting frequency selection and notch depth selection	H0000	
BFM #15064	BFM #15264	Error excessive alarm level	1 to 200 REV	K3	Subsection 11.2.3
BFM #15065	BFM #15265	Electromagnetic brake sequence output	0 to 1000 ms	K0	
BFM #15066	BFM #15266	Encoder output pulses selection	Selects the direction/setting for encoder pulse output	H0000	
BFM #15067	BFM #15267	Function selection C-1	Selection of serial encoder cable (2-wire or 4-wire type)	H0000	
BFM #15068	BFM #15268	Function selection C-2	Selects validity for operations without motor	K0	
BFM #15069	BFM #15269	Function selection C-3 (Ver. 1.40 or later)	Selects the error excessive alarm level setting	H0000	
BFM #15070	BFM #15270	Zero speed	0 to 10000 r/min.	K50	
BFM #15072	BFM #15272	Analog monitor output 1	Setting of output signal to analog monitor 1	H0000	
BFM #15073	BFM #15273	Analog monitor output 2	Setting of output signal to analog monitor 2	H0001	
BFM #15074	BFM #15274	Analog monitor 1 Offset	-999 to 999 mV	K0	
BFM #15075	BFM #15275	Analog monitor 2 Offset	-999 to 999 mV	K0	

BFM number		Item	Settings	Default value	Reference
X axis	Y axis				
BFM #15076	BFM #15276	Analog monitor feedback position output standard data Low (Ver. 1.40 or later)	Setting of standard position of feedback output with analog monitor 1 (MO1) or 2 (MO2)	K0	Subsection 11.2.3
BFM #15077	BFM #15277	Analog monitor feedback position output standard data High (Ver. 1.40 or later)	Setting of standard position of feedback output with analog monitor 1 (MO1) or 2 (MO2)	K0	
BFM #15080	BFM #15280	Function selection C-4	Select the home position setting condition in the absolute position detection system	K1	
BFM #15083	BFM #15283	Function selection C-7 (Ver. 1.40 or later)	Setting when undervoltage alarm occurs	H0000	
BFM #15084	BFM #15284	Alarm history clear (Ver. 1.40 or later)	Used to clear the alarm history	H0000	
BFM #15087	BFM #15287	Forced stop deceleration time constant (Ver. 1.40 or later)	Only the MR-J3-□BS and MR-J4(W2)-□B Setting of deceleration time constant for forced stop deceleration	H0000	
BFM #15094	BFM #15294	Vertical axis freefall prevention compensation amount (Ver. 1.40 or later)	Only the MR-J3-□BS and MR-J4(W2)-□B Setting of compensation amount of the vertical axis freefall prevention function	H0000	Subsection 11.2.4
BFM #15102	BFM #15302	Output signal device Selection 1 (CN3-13)	Setting of output signal to the connector (CN3-13 pin) of servo amplifier	H0005	
BFM #15103	BFM #15303	Output signal device Selection 2 (CN3-9)	Setting of output signal to the connector (CN3-9 pin) of servo amplifier	H0004	
BFM #15104	BFM #15304	Output signal device Selection 3 (CN3-15)	Setting of output signal to the connector (CN3-15 pin) of servo amplifier	H0003	
BFM #15109	BFM #15309	Function selection D-3 (Ver. 1.40 or later)	Selects the ALM output signal at warning occurrence.	H0000	

11

Buffer Memory

12

Program Example

13

Diagnostics

A

List of Parameters and Data

B

Version Information

Appendix B: Version Information

Appendix B-1 Version Information

Appendix B-1-1 Version check method

The version of 20SSC-H can be checked by the following method.

- 1) In the 20SSC-H, users can obtain the 20SSC-H version information by monitoring buffer memory #17 (decimal number).
- 2) The Version of the product can be seen from the manufacturer's serial number "VERSION" indicated on the label adhered to the right side of the product.

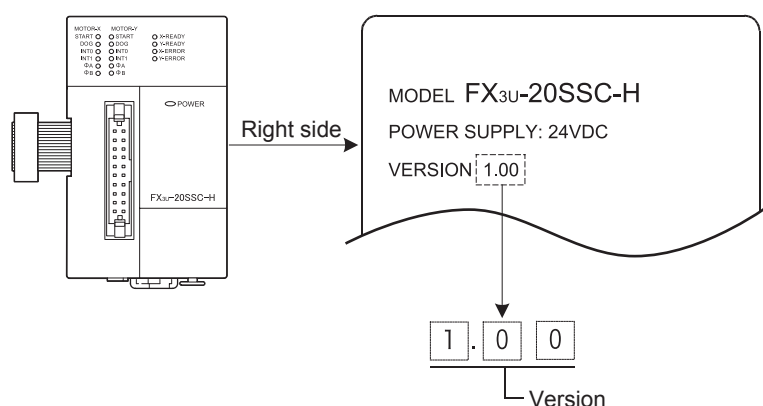

Appendix B-1-2 Version Upgrade History

The 20SSC-H has undergone the following upgrades.

Version	Contents of version upgrade
Ver.1.00	First product
Ver.1.10	<ul style="list-style-type: none"> • Reciprocal movement instruction added to Positioning Operation Patterns • Ring counter setting added <ul style="list-style-type: none"> - Ring operation rotation direction for absolute address • Mode Selection added to the Interrupt 1-speed Constant Quantity Feed • The following functionalities added to MPG Input Operation <ul style="list-style-type: none"> - MPG Response - Torque Limit - MPG Input Selection • Servo Parameter Transfer Mode added • System Reset added • The servo parameter update stop command function is added
Ver.1.20	<ul style="list-style-type: none"> • Sudden stop selection added • Interpolation gear ratio selection • Real current value monitor added • Positioning completion signal output waiting time added • Received target address added • Received target speed added • Positioning completion signal output waiting time added

Version	Contents of version upgrade
Ver.1.30	<ul style="list-style-type: none"> • A function is added to select the servo ON/OFF status at startup. • A function is added to monitor the address at the time of interrupt occurrence. • A setting is added for interrupt 1-speed constant quantity feed (constant position stop mode) shortest allowable stop. • A function is added to select the acceleration/deceleration time. • When the absolute position detection system is used, ring operation allows unlimited length feed. • The contents of setting of the regenerative brake option are added. • The continuous pass operation with m code (with mode) is changed.
Ver.1.40	<ul style="list-style-type: none"> • The following servo parameters are added: <ul style="list-style-type: none"> - Control mode - Overshoot amount compensation - Vibration suppression control filter 2 - Function selection C-3 - Analog monitor feedback position output standard data Low - Analog monitor feedback position output standard data High - Function selection C-7 - Alarm history clear - Forced stop deceleration time constant - Vertical axis freefall prevention compensation amount - Function selection D-3 • The following servo parameters are changed. <ul style="list-style-type: none"> - Servo series - Function selection A-1 • The following error codes are added: <ul style="list-style-type: none"> - STO signal OFF error - Encoder error 3 (during runtime) - Forced stop error - STO timing error • The following servo warning code is added: <ul style="list-style-type: none"> - STO warning
Ver.1.50	<ul style="list-style-type: none"> • The following error codes are added: <ul style="list-style-type: none"> - Operation mode error

11
Buffer Memory

12
Program Example

13
Diagnostics

A
List of Parameters and Data

B
Version Information

Warranty

Please confirm the following product warranty details before using this product.

1. Gratis Warranty Term and Gratis Warranty Range

If any faults or defects (hereinafter "Failure") found to be the responsibility of Mitsubishi occurs during use of the product within the gratis warranty term, the product shall be repaired at no cost via the sales representative or Mitsubishi Service Company. However, if repairs are required onsite at domestic or overseas location, expenses to send an engineer will be solely at the customer's discretion. Mitsubishi shall not be held responsible for any re-commissioning, maintenance, or testing on-site that involves replacement of the failed module.

[Gratis Warranty Term]

The gratis warranty term of the product shall be for one year after the date of purchase or delivery to a designated place. Note that after manufacture and shipment from Mitsubishi, the maximum distribution period shall be six (6) months, and the longest gratis warranty term after manufacturing shall be eighteen (18) months. The gratis warranty term of repair parts shall not exceed the gratis warranty term before repairs.

[Gratis Warranty Range]

- 1) The range shall be limited to normal use within the usage state, usage methods and usage environment, etc., which follow the conditions and precautions, etc., given in the instruction manual, user's manual and caution labels on the product.
- 2) Even within the gratis warranty term, repairs shall be charged for in the following cases.
 - a) Failure occurring from inappropriate storage or handling, carelessness or negligence by the user. Failure caused by the user's hardware or software design.
 - b) Failure caused by unapproved modifications, etc., to the product by the user.
 - c) When the Mitsubishi product is assembled into a user's device, Failure that could have been avoided if functions or structures, judged as necessary in the legal safety measures the user's device is subject to or as necessary by industry standards, had been provided.
 - d) Failure that could have been avoided if consumable parts (battery, backlight, fuse, etc.) designated in the instruction manual had been correctly serviced or replaced.
 - e) Relay failure or output contact failure caused by usage beyond the specified Life of contact (cycles).
 - f) Failure caused by external irresistible forces such as fires or abnormal voltages, and failure caused by force majeure such as earthquakes, lightning, wind and water damage.
 - g) Failure caused by reasons unpredictable by scientific technology standards at time of shipment from Mitsubishi.
 - h) Any other failure found not to be the responsibility of Mitsubishi or that admitted not to be so by the user.

2. Onerous repair term after discontinuation of production

- 1) Mitsubishi shall accept onerous product repairs for seven (7) years after production of the product is discontinued.
Discontinuation of production shall be notified with Mitsubishi Technical Bulletins, etc.
- 2) Product supply (including repair parts) is not available after production is discontinued.

3. Overseas service

Overseas, repairs shall be accepted by Mitsubishi's local overseas FA Center. Note that the repair conditions at each FA Center may differ.

4. Exclusion of loss in opportunity and secondary loss from warranty liability

Regardless of the gratis warranty term, Mitsubishi shall not be liable for compensation of damages caused by any cause found not to be the responsibility of Mitsubishi, loss in opportunity, lost profits incurred to the user or third person by Failures of Mitsubishi products, special damages and secondary damages whether foreseeable or not, compensation for accidents, and compensation for damages to products other than Mitsubishi products, replacement by the user, maintenance of on-site equipment, start-up test run and other tasks.

5. Changes in product specifications

The specifications given in the catalogs, manuals or technical documents are subject to change without prior notice.

6. Product application

- 1) In using the Mitsubishi MELSEC programmable logic controller, the usage conditions shall be that the application will not lead to a major accident even if any problem or fault should occur in the programmable logic controller device, and that backup and fail-safe functions are systematically provided outside of the device for any problem or fault.
- 2) The Mitsubishi programmable logic controller has been designed and manufactured for applications in general industries, etc. Thus, applications in which the public could be affected such as in nuclear power plants and other power plants operated by respective power companies, and applications in which a special quality assurance system is required, such as for Railway companies or Public service purposes shall be excluded from the programmable logic controller applications.
In addition, applications in which human life or property that could be greatly affected, such as in aircraft, medical applications, incineration and fuel devices, manned transportation, equipment for recreation and amusement, and safety devices, shall also be excluded from the programmable logic controller range of applications.
However, in certain cases, some applications may be possible, providing the user consults their local Mitsubishi representative outlining the special requirements of the project, and providing that all parties concerned agree to the special circumstances, solely at the users discretion.

Revised History

Date	Revision	Description
12/2005	A	First Edition
1/2006	B	<ul style="list-style-type: none"> • "Power-on Timing" added [Subsection 5.2.1] • Clerical Error Correction [Subsection 3.4.1, 8.1.4, 8.1.5, 8.3.1, 8.3.3, 9.2.1, Section 9.9, 12.4, Appendix A-1, Appendix A-3]
4/2006	C	<ul style="list-style-type: none"> • The Error Code (2013) content and countermeasures added [Subsection 13.2.3] • Clerical Error Correction
2/2007	D	<ul style="list-style-type: none"> • UL, cUL Compliance added • Supported in Ver.1.10 • Reciprocal movement instruction added to Positioning Operation Patterns [Section 9.12] • Ring counter setting added [Section 7.7] <ul style="list-style-type: none"> - Ring operation rotation direction for absolute address • Mode Selection added to the Interrupt 1-speed Constant Quantity Feed [Subsection 9.3.1, 9.3.2] • The following functionalities added to MPG Input Operation [Section 8.3] <ul style="list-style-type: none"> - MPG Response - Torque Limit - MPG Input Selection • Servo Parameter Transfer Mode added [Subsection 6.3.3] • System Reset added [Subsection 6.3.4] • The servo parameter update stop command function is added (Subsection 6.3.3). • User's Manual error corrected
7/2007	E	<ul style="list-style-type: none"> • Supported in Ver.1.20 • Sudden stop selection added [Section 7.5] • Cautions for interpolation operation [Subsection 7.10.3] • The following functionalities added to positioning parameters [Section 11.1] <ul style="list-style-type: none"> - Operation parameter 2 <ul style="list-style-type: none"> b4 : Sudden stop selection (STOP command) b5 : Sudden stop selection (software limit) b6 : Sudden stop selection (PLC limit) b7 : Sudden stop selection (Servo amplifier limit) b14 : Interpolation gear ratio selection - Sudden stop deceleration time - Sudden stop interpolation time constant - Positioning completion signal output waiting time • The following functionalities added to monitor data [Section 11.3] <ul style="list-style-type: none"> - Real current address (User) - Real current address (Pulse) - Received target address - Received target speed - Status information 2 <ul style="list-style-type: none"> b0 : Positioning parameter change completion flag • Version Information added [Appendix B]
1/2010	F	<ul style="list-style-type: none"> • Supports the FX3UC (D, DSS) Series PLC and FX3UC-32MT-LT-2. • Connection via GOT1000 (GT15, GT11) series transparent mode added. [FX Configurator-FP Ver. 1.30 or later] • Supported in Ver.1.30 <ul style="list-style-type: none"> - Servo startup ON/OFF selection add. [Subsection 7.9.6] - A function is added to monitor the address at the time of interrupt occurrence. [Sections 9.3, 9.5, 9.6 and 9.10 and Subsection 11.3.21] - A setting is added for interrupt 1-speed constant quantity feed (constant position stop mode) shortest allowable stop. [Subsection 9.3.2] - A function is added to select the acceleration/deceleration time. [Section 7.7]

Date	Revision	Description
1/2010	F	<ul style="list-style-type: none"> • Supported in Ver.1.30 <ul style="list-style-type: none"> - When the absolute position detection system is used, ring operation allows unlimited length feed. [Section 7.8] - The contents of setting of the regenerative brake option are added. [Subsection 11.2.1] - The continuous pass operation with m code (with mode) is changed. [Section 10.10] • Timing at which the set data becomes valid. [Sections 6.2, 11.1, 11.2, 11.4 and 11.5] • The contents of description are reviewed. [Sections 5.3, 6.2 and 6.3 and Chapters 7, 8, 9 and 10] • User's Manual errors corrected.
12/2010	G	<ul style="list-style-type: none"> • Supported in Ver.1.40 <ul style="list-style-type: none"> - Servo parameters are added [Sections 11.2 and Appendix A-5] - Error codes are added [Subsection 13.2.3] - Servo warning code is added [Subsection 13.2.4] • MR-J3W-□B is added • MR-J3-□BS is added • User's Manual errors corrected.
7/2011	H	<ul style="list-style-type: none"> • User's Manual errors corrected.
11/2011	J	<ul style="list-style-type: none"> • Wiring precaution description expanded and corrected. • User's Manual errors corrected.
12/2012	K	<ul style="list-style-type: none"> • Supported in Ver.1.50 <ul style="list-style-type: none"> - Error codes are added [Subsection 13.2.3] • MR-J4-□B is added. • User's Manual errors corrected.
6/2014	L	<ul style="list-style-type: none"> • MR-J4W2-□B is added. • "Preparing the power cable by yourself" is deleted. [Subsection 5.1.2] • User's Manual errors corrected.
4/2015	M	<ul style="list-style-type: none"> • The description of speed switching in the 2-speed positioning operation and multi-speed operation is added. • User's Manual errors corrected.

FX₃U-20SSC-H

USER'S MANUAL

MITSUBISHI ELECTRIC CORPORATION

HEAD OFFICE: TOKYO BUILDING, 2-7-3 MARUNOUCHI, CHIYODA-KU, TOKYO 100-8310, JAPAN

MODEL	FX3U-20SSC-U-E
MODEL CODE	09R622