

# FX Family

## MELSEC PLC

The world's favorite  
micro PLCs



**13 Million FX PLCs Worldwide / Over 30 Years Experience /  
Expanded Micro PLC Control / Networking Solutions / Analog  
Solutions / Positioning Solutions /**

# Global Leader



The MELSEC FX3 series are the third generation on programmable controllers of the Mitsubishi Electric FX family. They offer improved network capability and solutions for positioning tasks.



Mitsubishi Electric Corporation Himeji Works is a factor ycertified for ISO14001 (standards for environmental management systems) and ISO9001(standards for quality assurance management systems)



## 13 Million FX

The FX Family of PLCs is the PLC of choice across the world, industries and applications. Mitsubishi Electric has always worked closely with its customers to design the PLC that they want for their applications. The manufacturing and use of 13 million FX CPUs is a demonstration that this close working relationship has delivered quality, reliability and the product that customers want.

## Over 30 Years

The FX Family of PLCs has been an important part of control engineering for over 30 years. Throughout its history, the product has evolved from the original F series into today's current FX3 series.

The FX Family has proven to be highly reliable and it consistently improves its compatibility with previous PLC generations.

## Number 1 in the world

Mitsubishi Electric was shown to be the largest volume producer of PLCs in the world following the 2004 Worldwide PLC survey by the respected American automation research company ARC.

# Contents

What makes a world leading PLC?	4-5	
Range overview	6	
FX3U/FX3UC, a new concept in PLCs	7-9	
FX3G/FX3GC, an automation standard	10	
FX3GE – the versatile PLC	11	
FX3S – micro control	12	
Programming and software	13	
Networking	14	
Analog solutions	15	
Positioning solutions	16	
Displays solutions	17	
Applications	18	

## Section 2: Technical Informations

# What makes a world leading PLC range?



## Global use

Wide range power supply means your FX solution will work all over the world.



## International acceptance

Shipping approvals such as Lloyds, German Lloyds, ABS, RINA, Det Norske Veritas, for example plus CE and E1 compliance for Low Voltage and EMC directives as well as manufacturing to Automotive industry quality levels, make the FX Family PLCs products to trust.

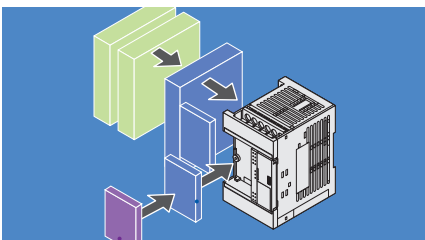

## Flexible design

The FX Family is designed so that the main PLC CPU acts as a platform to which you can add and customize the special functions you need – making every FX your personal PLC.

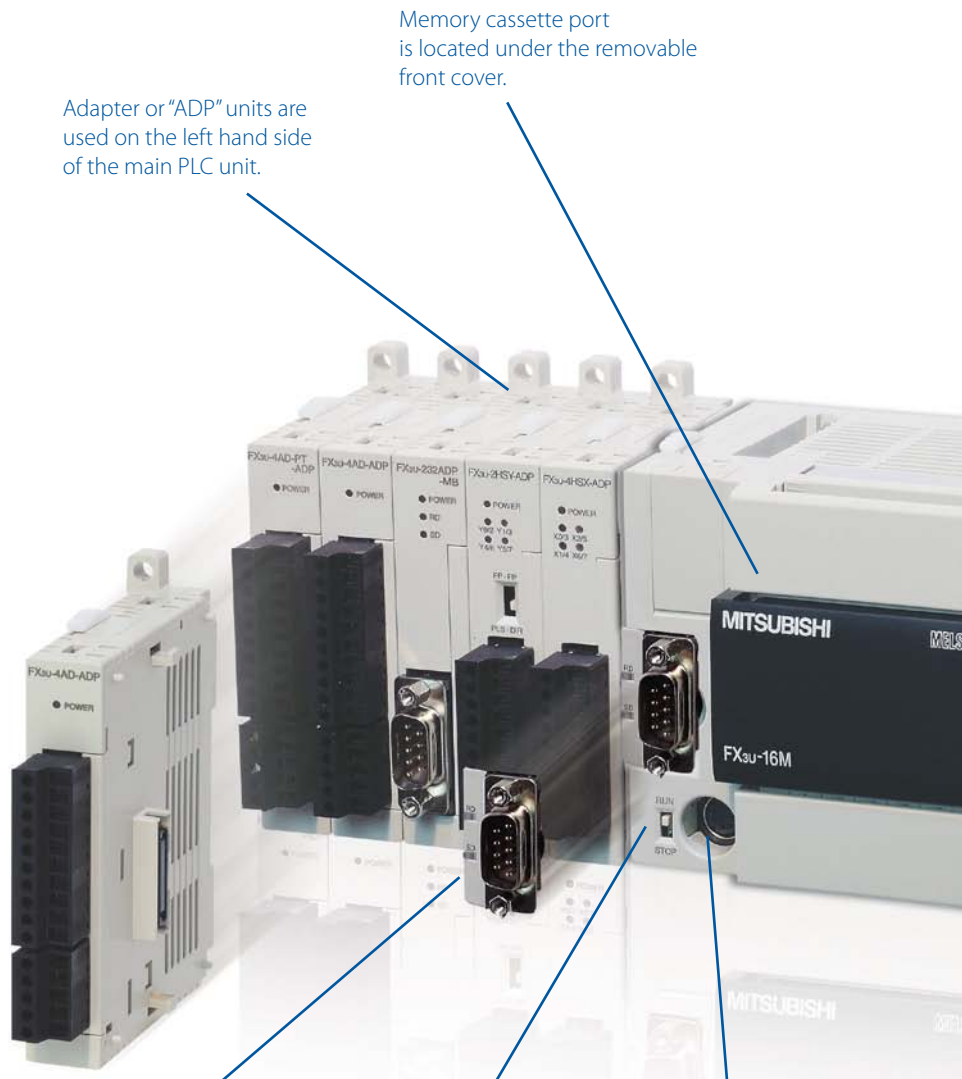

Adapter or "ADP" units are used on the left hand side of the main PLC unit.

Memory cassette port is located under the removable front cover.

Optional communication boards are available in USB, RS232C, RS422 and RS485 formats.

The RUN/STOP switch has become a familiar feature with all FX Family PLCs.

The standard RS422 Mini-DIN programming port can also be used for HMI connection.

Main base unit where CPU, I/O and power supply are contained in a single unit.

All FX PLC units can be mounted on a DIN rail or directly mounted with screw fixings.

Simple ribbon connection links each unit together.

Special function blocks can be added to the right hand communications bus of the PLC.

Bright LED lamps indicate I/O and power status.

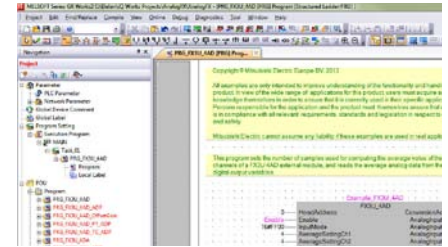
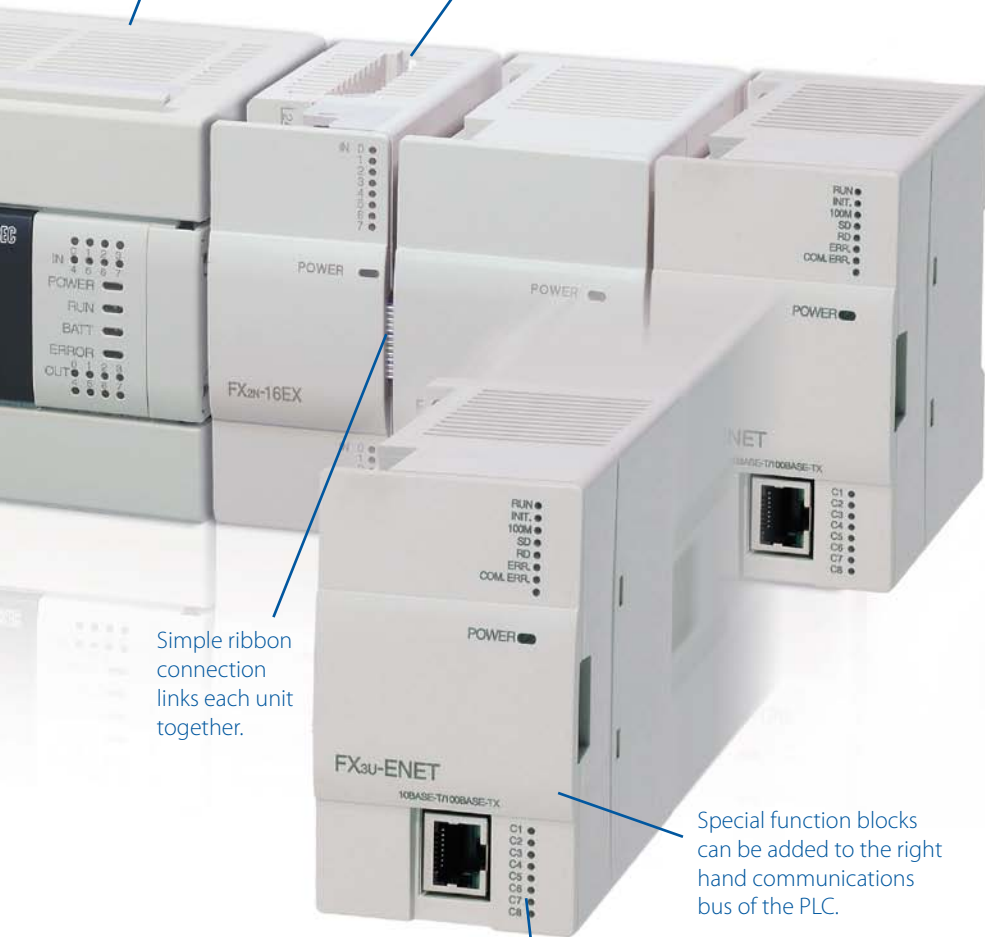

## Easy Programming

The FX Family incorporates an easy programming concept where several complex tasks can be reduced to a single instruction.



## Fast and reliable

FX PLCs continually push the limits of high speed operation to process your applications more effectively and accurately.

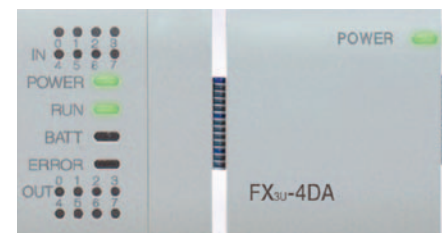

## Compatibility

The FX Family of PLCs continues to raise the level of backward compatibility with many existing FX PLC programs being transferable. And in later models, sharing common peripherals and special function blocks means even greater protection for your investment in both FX and the machine or process being controlled.



# FX3U a perfect PLC concept

The FX3U CPU brings a combination of greater flexibility and increased performance to the FX Family.

## High performance

Thanks to the flexible expansion options of the FX3U series, the PLC can be optimally adapted to the respective requirements.

Following the standard FX Family configuration, the FX3U CPU can be expanded to the right hand side using a wide range of options. These include input and output blocks as well as special function blocks such as analog, pulse train and network communication units.

The FX3U series has a fast communications bus that automatically switches into high speed mode and handles the communication with increased speed, when the new FX3U expansion modules are connected.

Full compatibility is still available with FX2N and FX0N expansion blocks, and when these are configured the FX3U automatically reduces the bus speed to suit.

This means greater support for existing installed systems as well as delivering high performance and greater response with new installations.



## Adapters add flexibility

An outstanding performance feature of the FX3U is the adapter expansion bus on the left hand side of the base unit. Through this bus users can add additional analog and temperature units as well as multiple communications and positioning blocks.

However, the major benefit for the user is that the analog and positioning adapter units no longer require the use of the traditional To/From instruction to configure and operate.

All control is through direct access data registers and setting bits. This means quicker setup, easier use, and above all much higher processing speeds.



FX3U has a unique new system of directly programmable adapters.



The FX3U can use FX3U expansion modules as well as standard FX2N and FX0N expansion modules.

# FX3U/FX3UC. More power. More performance.

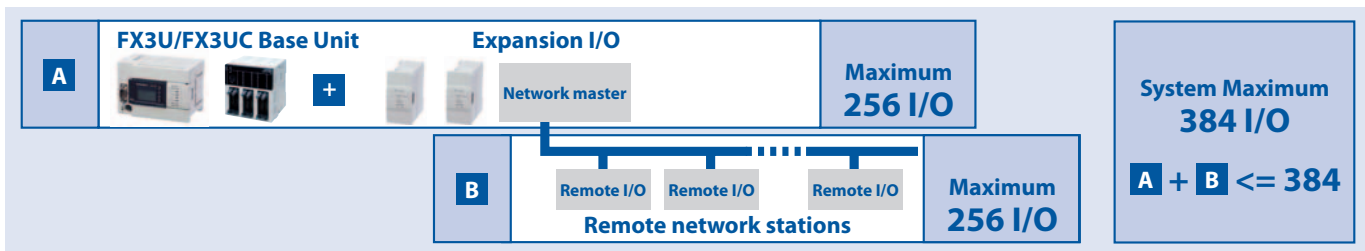

FX3U/FX3UC provides additional I/O and networking capacity.

	FX3U/FX3UC	FX2N
Basic instruction	0.065 $\mu$ s	0.08 $\mu$ s
Applied instruction (MOV)	0.642 $\mu$ s	1.52 $\mu$ s

FX3U/FX3UC provides increased performance in all areas.

Note: 4.5 times increase in speed is measured under the following conditions: program capacity = 16 k step, with an I/O usage of 144 points. Program scan time is then; FX3U/FX3UC: 4.6 ms and FX2N: 21.0 ms, an increase in processing speed of 4.56 times.

	FX3U/FX3UC	FX2N
Auxiliary Relay (M)	7680 points	3072 points
State Flags (S)	4096 points	1000 points
Timers (T)	512 points	256 points
Data Registers (D)	40768* points	8000 Adressen

\*Includes R Registers

FX3U/FX3UC offers increased resources as well as increased performance.

## Increased I/O capacity

With enhanced networking functions, the FX3U/FX3UC requires an increased input/output (I/O) range. FX3U/FX3UC can support systems with combined local I/O and networked I/O up to a total of 384 I/O points. For users, this means increased system control and added possibilities for advanced networks.

In addition FX3U/FX3UC also fully supports Profibus DP as well as Ethernet using TCP and UDP protocols.

## Up to 4.5 times faster

The time that is required for the execution of instructions in the FX3U/FX3UC is dramatically reduced. This means a logical instruction is being processed in only 0.065  $\mu$ sec.

For users this means quicker program response and more accurate process performance as inputs, outputs and actions are processed and monitored more times per second.

## 8 times more memory

The FX3U/FX3UC comes with a standard internal memory of 64 k steps, which is 8 times more memory than in the previous model.

More memory means users can write larger and more complex programs, store more data in file registers, or take greater advantage of using IEC 61131-3 style programming tools.

## 5 times more data storage

With a larger program memory comes the need for more operational devices such as timers, state flags, auxiliary relays and data registers. The FX3U/FX3UC has increased capacity in all of these major areas making program construction easier. Data register capacity has increased by a factor of 5 reflecting the needs of users who have an increased requirement to log operation information against products or batches of products being manufactured.

A typical example of this can be found in the Food and Pharmaceutical industries. Here exact process data such as oven temperatures and cooking times or quantities of ingredients mixed need to be stored against production batches – all this requires increased data handling and data capacity within the PLC.

## 75 new instructions

Compared to the previous model, the FX3U/FX3UC offers with 75 new instructions an enormously enhanced programming instruction set. A total of 209 instructions are available. All of the instructions follow the traditional FX Applied instruction concept designed to make the task of application building and program writing easier and quicker, with less chance for errors.





Adapter modules increase positioning performance.

New instructions include greater control over data processing with a range of new comparison and string manipulation commands.

- LOGE (Nr. 125)**  
Calculates the natural logarithm in floating point
- SORT2 (Nr. 149)**  
Sort tabulated data
- TBL (Nr. 152)**  
Batch data positioning mode
- BAND (Nr. 257)**  
Defines a band or range of valid numbers
- IVWR (Nr. 273)**  
Write parameter to inverter

Some examples of instructions from the FX3U/FX3UC.

## Simple high speed positioning

The FX3U/FX3UC has been designed with six high speed counters that can each count up to 100 kHz simultaneously per channel. This, combined with three 100 kHz pulse train outputs, means users can directly configure simple 3-axis positioning systems without the use of additional modules.

However, the new high speed counter ADP and pulse train ADPs can provide the FX3U/FX3UC with maximum positioning performance. Each unit can process signal speeds of up to 200 kHz.

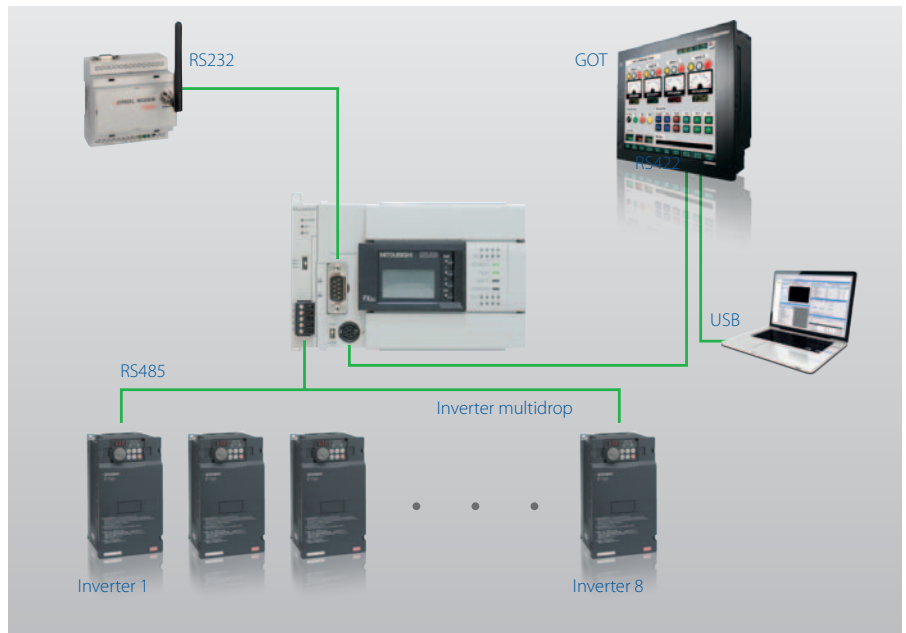

FX3U/FX3UC has a range of flexible communication options.

## A great communicator

FX3U/FX3UC has strengthened the communications capability of the FX Family even further.

The new adapters allow up to three RS communication channels to be operated simultaneously allowing multiple HMIs to be connected to a single FX3U/FX3UC CPU or combinations of HMIs, third party devices and programming tools – the choice is yours.

The FX3U/FX3UC also supports a wide range of network options including Modbus, Profibus DP, CC-Link, DeviceNet, CANopen as well as Ethernet.

The FX3UC is the ideal choice for applications where there is not much space for the controller hardware. The smallest base unit takes up just 27 % of the space required for a comparable FX3U unit – and yet the FX3UC incorporates all the features of the FX3U.

The connections for the FX3UC inputs and outputs on the front side can be wired with ribbon cable connectors. For this purpose system cabling sets and remote I/O terminal blocks for easy and fast connections are available.

## FX3U/FX3UC at a glance

- I/O range**  
16–384 (Discrete I/O, maximum 256)
- Program memory**  
64 k steps (standard)
- Basic instruction processing**  
0.065 µsec/logical instruction
- Analog signal processing**  
Up to 80 analog inputs,  
Up to 48 analog outputs
- Analog resolution**  
8, 12 and 16 bits
- Analog options**  
19 analog input, output and temperature blocks available for selection
- Positioning**  
Internal:  
6 high speed counters (100 kHz)  
2 high speed counters (10 kHz)  
3 pulse train outputs (100 kHz), transistor unit only  
External (FX3U only):  
High speed counter block (50 kHz)  
High speed counter ADP module (200 kHz)  
Pulse train ADP (200 kHz)  
Pulse train output block (1 MHz)

# FX3G/FX3GC – an industry standard



FX3G/FX3GC PLCs are used in many applications for processing and packaging as well chilled storage and transportation of food items.



Since its launch, the FX3G has been a standard of micro PLC control.



FX3G/FX3GC has the versatility to handle applications from a wide range of industries.

## Customized control

The FX3G/FX3GC is an introductory compact PLC and is the addition to the FX3 series, designed for simple yet performance critical applications that require discrete control of up to 128 local I/O or up to 256 I/O with CC-Link remote I/Os. Incorporating innovative FX3 series technology the customer is presented with a suite of benefits. These include a large program memory to implement sophisticated algorithms plus high speed execution to enhance system productivity.

## Highly flexible

A dual bus architecture provides flexible expansion possibilities and with the ability to handle analog, high speed, positioning, and inverter control, the FX3G/FX3GC is able to successfully adapt to a range of applications in industry areas such agriculture, water processing, material handling, food processing and more.

## The great communicator

With a wide range of network and serial protocols available, such as Ethernet, CC-Link and Modbus, the FX3G/FX3GC enables seamless integration and data communications between both Mitsubishi Electric and thirdparty devices. Furthermore, a builtin USB port permits convenient connection to any PC or laptop.

## FX3G/FX3GC at a glance

### I/O range

14–256 (Discrete I/O, maximum 128)

### Program memory

32 k steps (internal)

### Basic instruction processing

0.21  $\mu$ s or 0.42  $\mu$ s/logical instruction

### Analog signal processing

Up to 74 analog inputs

Up to 41 analog outputs

### Analog resolution

8, 12 and 16 bit

### Analog options

19 analog input, output and temperature blocks available for selection

### Positioning

Internal:

Up to 4 high speed counters (max. 10 kHz)

up to 2 high speed counters (max. 60 kHz)

up to 3 (2) pulse train outputs (100 kHz)

# FX3GE – the versatile PLC

The FX3GE series is the most versatile com-pact PLC from Mitsubishi Electric and introduces yet another top model to the FX3 range. In addition to the powerful functions of the FX3G series, the FX3GE also boasts integral analog inputs/outputs and Ethernet connectivity. Other features include an RS422 interface and an USB programming port. The FX3GE therefore sets new class standards for compact PLCs; it provides excellent value for money, and is ideally suited for many applications. Typical fields of use include the foodstuffs industry, processing machines, packaging technology, pumps and refrigeration systems.

## Strong performance

For processing analog values, the FX3GE comes as standard with two analog inputs and one analog output, each having a resolution of 12 bits (0–4000). The FX3GE also features an Ethernet port with a transmission rate of 100/10 Mbit/s. The Ethernet port is ideal for programming and monitoring and for making online modifications. It also enables the unit to be connected to graphical operating panels (HMI), such as Mitsubishi Electric’s GOT series. With this Ethernet port, the FX3GE also provides a facility for monitoring process values using a web browser. The PLC can therefore be maintained and monitored regardless of where the FX3GE is installed. Appropriate access rights can be assigned using different password levels.



Sequence control in the food industry

**FX3GE at a glance**

- I/O range**  
24–256 (Discrete I/O, maximum 128)
- Program memory**  
32 k steps
- Basic instruction processing**  
0.21 μs or 0.42 μs/logical instruction
- Analog signal processing**  
Up to 74 analog inputs  
Up to 41 analog outputs
- Analog resolution**  
8, 12 and 16 bit
- Analog options**  
19 analog input, output and temperature blocks available for selection
- Positioning**  
Internal:  
Up to 4 high speed counters (max. 10 kHz)  
up to 2 high speed counters (max. 60 kHz)  
up to 3 (2) pulse train outputs (100 kHz)



Built-in Ethernet interface



Monitoring via the web interface

# FX3S micro control



FX3S has been used in a wide range of embedded control applications.



FX3S offers communication and real time control from a single unit.

The FX3S series PLC provides full function PLC control, builtin highspeed inputs and outputs, either relay or transistor outputs, and multiple, builtin communication ports. It also includes expansion options for communications, analog, and temperature control. The FX3S-30MT/ESS-2AD and FX3S-30MR/ES-2AD comes also with two builtin analog inputs (0–10 V DC). In addition, optional expansion possibilities for communication, analog or temperature value processing are available. As part of the FX3 series, the FX3S can use many of the existing programming resources that are available for other FX3 series PLCs. This greatly reduces time and costs for system set up.

## Fit and forget

Typically FX3S applications are small, embedded control functions that are hidden away or inaccessible under normal maintenance activities. This is why the FX3S has been designed to be a robust low maintenance PLC. Features such as the maintenance free, 4000 step EEPROM memory and real time clock management all help to make the FX3S a self managing system, reducing the impact on the maintenance engineer.

## Remote control

The FX3S has an additional range of BD expansion boards providing RS232, RS485, RS422 or Ethernet communications options. These can be used to connect and control various third party products such as bar code readers or panel printers.

## FX3S at a glance

### I/O range

10–30

### Program memory

4 k steps (standard)

### Basic instruction processing

0.21  $\mu$ s/logical instruction

### Analog signal processing

FX3S-30M□/□-2AD; 2 integrated analog inputs

FX3S-□M□/□; 2 analog inputs or 2 analog outputs optionally

### Analog resolution

12 bit

### Analog options

2 analog input BD board

1 analog output BD board

### Positioning

Internal:

2 high speed counters 60 kHz,

4 high speed counters 10 kHz

2 pulse train outputs (100 kHz),

transistor unit only

# Progressive software concepts

The Mitsubishi Electric FX PLC Family has a worldwide reputation for reliability, performance and ease of use. These key values have also been used to form Mitsubishi Electric's integrated software concept, MELSOFT.

## Simple programming

The FX Family has a simple programming structure combining Basic and Applied instructions. The Basic instructions are common to all FX Family PLCs. Applied instructions provide the specialist control options such as data comparisons, PID and communications control, all of which are available on FX series. By the graded performance of each PLC series of the FX family, the number of available application instructions increases.

## Productivity tools

Programming software for PLCs is constantly evolving. Users are placing more focus on reusable program code and function block concepts. This helps to reduce errors, reduce programming time and to help manage the whole programming process – increasing overall productivity.

## Simple and intuitive

The key to any good software is that it is simple to use. Mitsubishi Electric's GX Works2 PLC programming packages have achieved this by using intuitive design.

GXWorks2 offers also comprehensive help functions and an advanced communications layer, ensuring safe reliable communication to the target PLC.

## Choose what you need

GX Works2 offers users the chance to program all Mitsubishi Electric MELSEC PLCs from a single package. However, for users who only need support for FX based systems there is GX Works2 FX.

Mitsubishi Electric provides with GXWorks2 IEC 61131-3 compliant programming, where programs in Instruction List, Ladder, Function Block, Structured Text or SFC formats can be created. Using standard programming languages, like IEC 61131-3, on large programming projects can help users save costs by creating reusable PLC code and Function Blocks.

## One step further with iQ Works

With the software suite iQ Works Mitsubishi Electric offers an integrated engineering environment. The intuitive user interface allows you to program and set up an iQ Platform, including system and network configuration, the programming of the MELSEC System Q, the MELSEC L series and the FX series, the establishment of motion controllers and servos, the design of user interfaces for operator panels of the GOT family as well as the programming of robots with the RT ToolBox2.



MELSOFT is a wide range of software solutions designed to optimize your plant productivity.



Often the biggest cost on a project is engineering time.

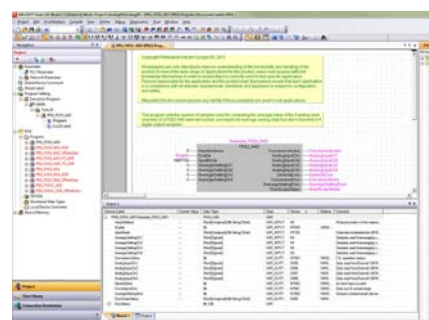

GX Works2 offers ease of use for programmers of all skill levels.

# Networking and communication solutions

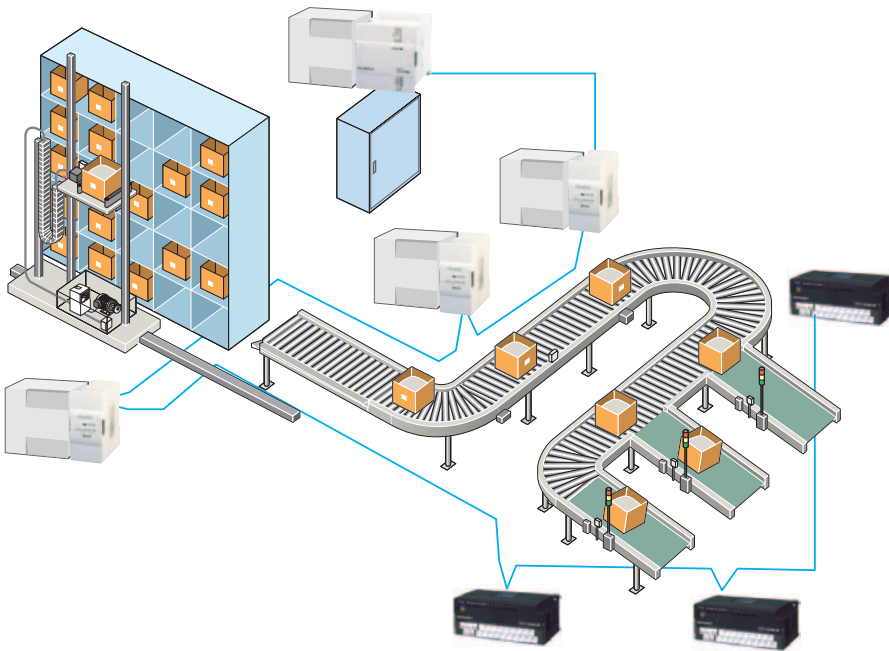

FX Family PLCs have a wide range of communications options.



Example of remote pumping station.

Applications are often required to integrate between each other across a factory, to report production or tracking data back for office based processing and in some cases be remotely monitored and maintained when the application is in an inaccessible location. The FX Family of PLCs has evolved to match this demand at all levels.

## Networks make sense

Networked solutions to complex applications often make the overall solution easier to achieve and more cost effective. For example a conveyor system integrated with a warehouse pick and place system may extend over many hundreds of meters, and by using a fieldbus, such as CC-Link, wiring, troubleshooting and maintenance can be dramatically reduced.

## Remote maintenance

With communications technology it is now possible to put PLC control in the most remote locations. Using a PLC with a RS232 interface to a telemetry solution, such as a GSM modem, allows the user the ability to remotely monitor and maintain the system. It can also allow the remote system to send alarm messages, warnings or general status information back to the user's central data processing centre.

## Easy communications

Today's FX Family of PLCs share a basic communication concept where additional RS232, RS422 or RS485 communications boards can be added to the main base unit without increasing the required cabinet space. These can then be used for communication to various third party devices like bar code readers, printers and modems.

FX3 Family PLCs have a wider range of communications modules. These include options for connection to open and bespoke networks such as Ethernet, Profibus DP, CC-Link, DeviceNet, CANopen or Modbus for example.

# Analog solutions

Analog control is one of the most important areas for any automation system. Critically for users the concern is to match the performance demanded by the application to the available solutions in a cost effective way.

## Where is analog used?

Analog control is widely used. In simple terms it allows a variable signal to be used to control items such as a motor's speed or to sense inputs such as fluid levels.

### ■ Digital to analog (D-A) control

Here a digital PLC value is output as an analog signal. It can be used, for example, to send a speed command to an inverter which in turn causes the motor to increase or decrease speed.

### ■ Analog to digital (A-D) control

In this type of control a variable signal is sent to a PLC where it is converted in to a direct digital value. An example of this could be the measurement of the level of a liquid in a storage tank so that the exact amount of stored liquid can be controlled by the PLC.

### ■ Temperature control

Temperature control is the third type of analog control. An example of use could be where the temperature of a furnace is measured and compared by the PLC against a set range. Additional heating or cooling can then be applied to maintain a constant temperature.

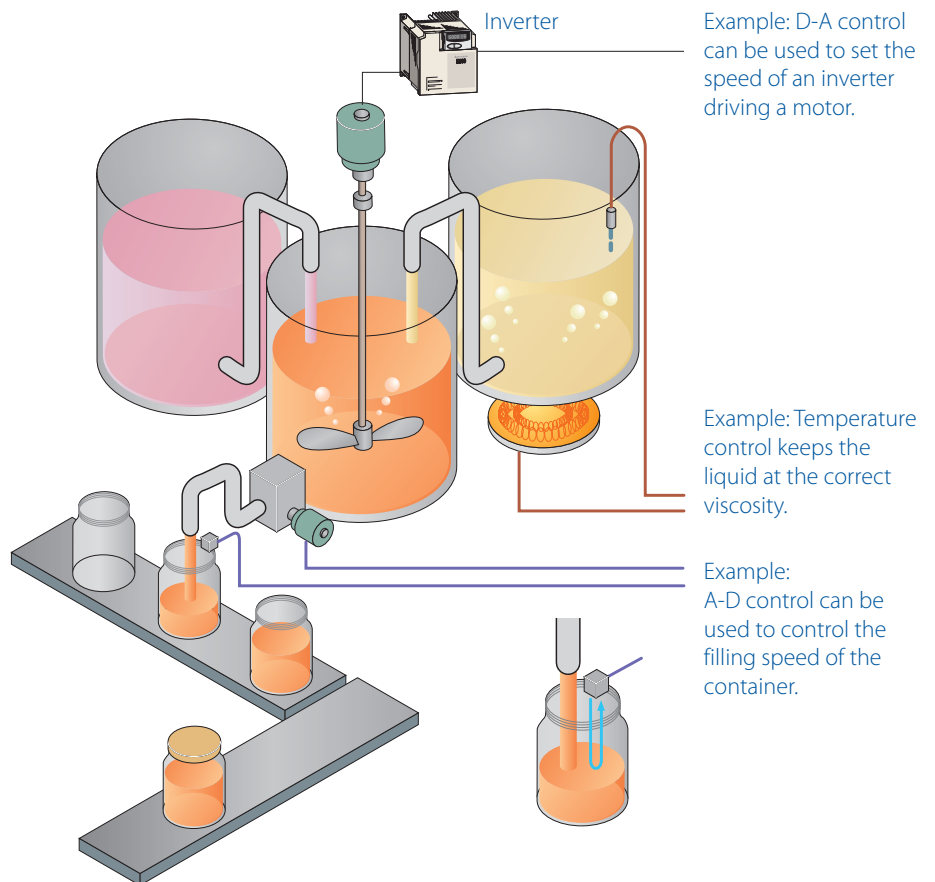

Analog solutions are an important part of control engineering and can be used to simplify and accurately control actions happening in the production environment.

## 24 solutions to choose from

The FX Family offers a wide range of analog solutions from 1 and 2 channel BD boards for FX3G up to 8 channel input blocks like the FX2N-8AD where temperature, voltage and current input can be mixed on the same block. FX analog blocks also come in a range of resolutions from 8 bit up to 16 bit signal processing. Overall there are 24 different analog options available to users of the FX PLC Family.

With this range of choice and flexibility it is sure that there will be a solution here for most applications.



Example of temperature control.

# Positioning solutions

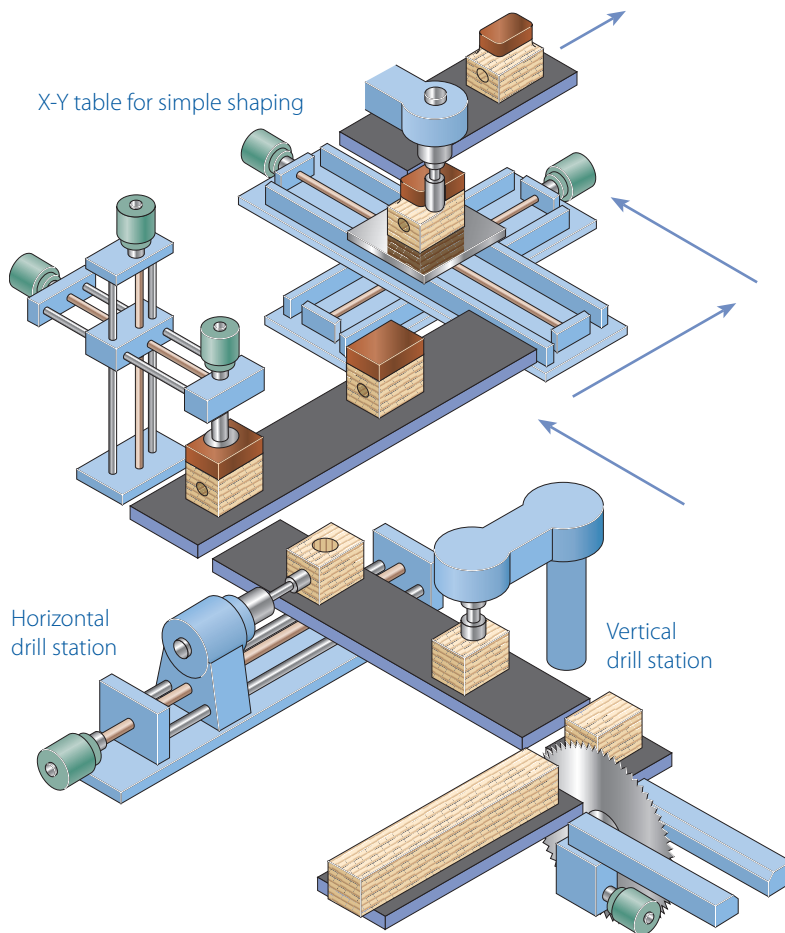

Simple positioning solutions can be effectively managed within a standard FX PLC.



Example of conveyor belt control.

Using simple positioning solutions can help increase the accuracy of the work process, reduce waste and rework as well as provide a higher quality of production.

## Typical applications

Simple positioning applications typically involve independently controlled operational axis and can sometimes have many requirements. In the example of an X-Y table, a relative position is achieved by driving each axis until its target position is achieved, regardless of what happens with the other axis. There are two main elements to achieve this type of positioning control.

### ■ Pulse train outputs

A stream of output pulses can be used as a drive signal to a line driver, stepper motor or servo amplifier, which then causes the connected motor to perform the positioning activity.

The larger the range of output pulse frequencies available means greater speed and/or accuracy is achievable. For example, if a stepper motor with a larger number of steps is used, the travel distance per step can be reduced, resulting in an increased system accuracy.

### ■ High speed counter input

When a motor is being driven, its relative position can be controlled by counting the number of output pulses.

However, for a more accurate process, reading the actual position from an encoder feedback directly into a high speed counter is preferred. This helps to overcome issues of backlash and slippage as the actual position is measured and not assumed.

## Positioning built in as standard

FX PLCs come with high speed counters (in some cases up to 100 kHz) and pulse train outputs (also in some cases up to 100 kHz) as standard. The high speed counters can be configured in single pulse train inputs, The high speed counters can be configured in a single or two phase input. Pulse train outputs can be configured to provide continuous pulse streams at different frequencies or a set quantity of pulses at a single frequency.

There are also optional modules and adapters that can provide additional high speed counters with performance up to 200 kHz. The same is true for pulse train outputs with 200 kHz and 1 Mpps (1 MHz) output options available.



# Display solutions

An increasingly important area of any automation solution is the reporting and display of operational information. This data enables operators, maintenance teams and business managers to make informed decisions in the best interests of the business.

## The right tool for the right job

For maximum efficiency, each user requires access to information at their work place in a form that highlights the important data for them first. This means a range of different tools are required. As an example, here are three possible scenarios.

### ■ The machine operator

Machines often have a lot of manufacturing debris around or are subject to hygienic cleaning as in the food industry. Any display located in this environment would need to have a high Ingress Protection (IP) rating, indicating a high degree of waterproofness.

It may also be a benefit to the operator to have a large and clear display to reduce the chances for error from misreading, due to poor light or small fonts being used. It is also recognized that the use of graphics also reduces the chances for reading errors with complex data.

### ■ The maintenance team

The critical information for a maintenance engineer is the error and diagnostic data within the PLC as this is used to diagnose any process problems. However, additional information regarding the operational "hours run" or cycles processed, which could be called soft information as it is calculated on operational parameters, could allow the maintenance engineer to predict possible failure and arrange preventative maintenance.

Access to this data could be through the machine operator's terminal, across a network or through a dedicated display mounted inside or on the control cabinet itself.

### ■ The business manager

In a production controllers office it would be better to display information through a network to their existing desktop PC. In this application a piece of software such as an OPC server/client, a Java applet, an Active X control or a SCADA system would allow lots of data from lots of sources to be displayed in a clear and concise way giving the production controller the overview of the business operation that they need.

## Data the way you want it

Mitsubishi Electric offers a wide range of visualization solutions from simple data displays such as the FX3U-7DM, advanced Graphic Operator Terminals like the GOT series, and a wide choice of software solutions from the MELSOFT software suite.

This powerful combination of hardware and software means there is a cost effective solution for most applications.



In the food industry hygiene is very important.



The FX3U-7DM can be directly mounted within the PLC (FX3U) or mounted on the front cabinet.



The GOT is a typical HMI

# Where have FX PLCs been used?



Sanitation management on Eurostar rollingstock.



Swimming pools are managed using FX PLCs.

Customer applications with FX PLCs have been wide spread from critical applications in pharmaceutical industries to sublime applications in the leisure industry. However, the FX PLC Family still remains the PLC of choice for many machine builders as it is flexible, compact and easy to use, which is why it is so often used.

Here are just a few examples of applications that customers have completed in the past

- Agriculture
  - Plant watering systems
  - Plant handling systems
  - Saw mill (wood)
- Building management
  - Smoke detection monitoring
  - Ventilation and temperature control
  - Lift (elevator) control
  - Automated revolving doors
  - Telephone management
  - Energy management
  - Swimming pool management
- Construction
  - Steel bridge manufacturing
  - Tunnel boring systems

- Food and drink
  - Bread manufacture (mixing/baking)
  - Food processing (washing/sorting/slicing/packaging)
- Leisure
  - Multiplex cinema projection
  - Animated mechatronics (museums/theme parks)
- Medical
  - Respiration machine testing
  - Sterilization
- Pharmaceutical/chemical
  - Dosing control
  - Pollution measurement systems
  - Cryogenic freezing
  - Gas chromatography
  - Packaging
- Plastics
  - Plastic welding systems
  - Energy management systems for injection molding machines
  - Loading/unloading machines
  - Blow molding test machines
  - Injection molding machines
- Printing
- Textiles
- Transportation
  - Sanitation on passenger ships
  - Sanitation on rail rolling stock
  - Fire tender, pump management
  - Waste disposal truck management
- Utilities
  - Waste water treatment
  - Fresh water pumping

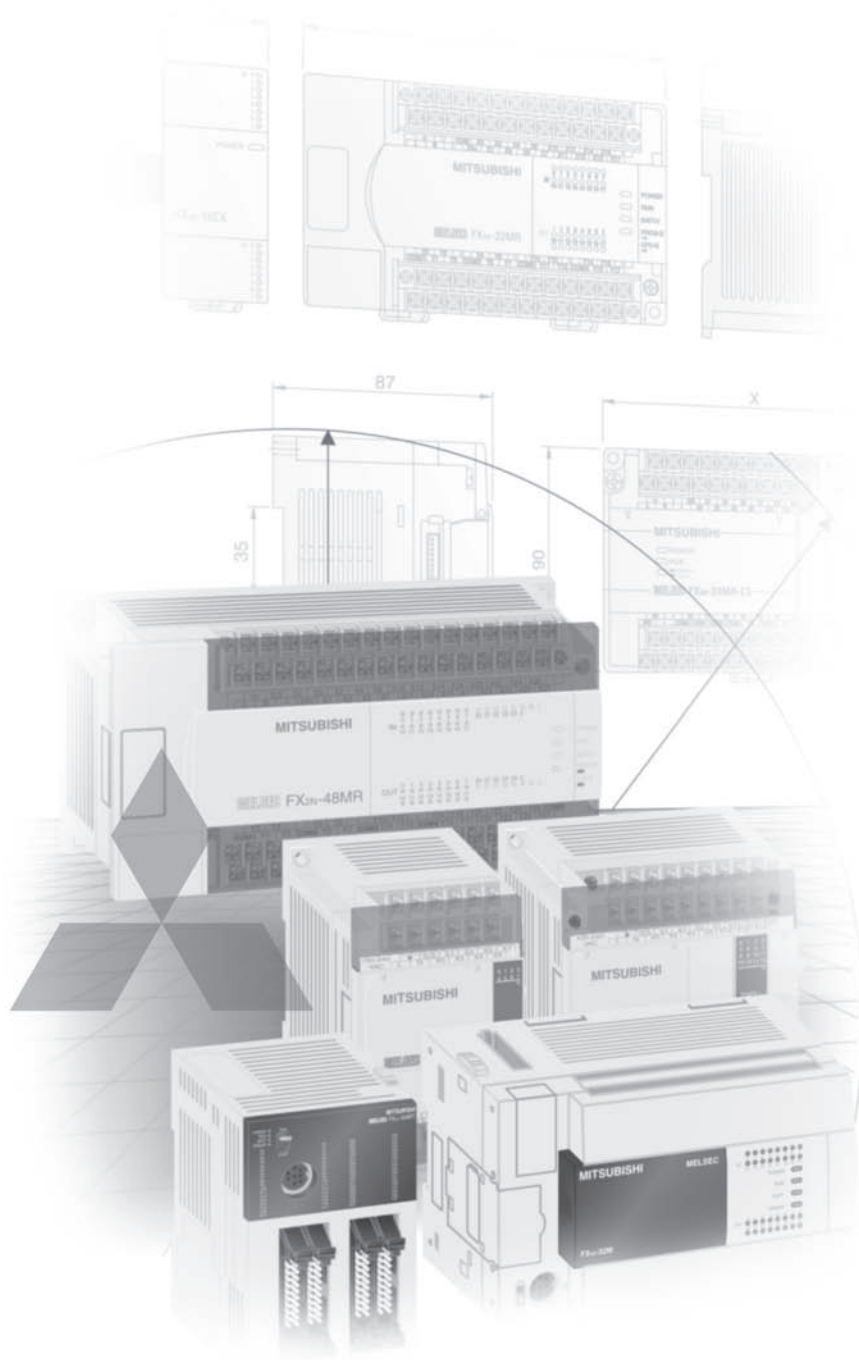

## Technical Information Section

## Further Publications within the Industrial Automation Range

### Brochures

#### **Q/L Family**

Product catalogues for programmable logic controllers and accessories for the further MELSEC PLC series

#### **HMI Family**

Product catalogue for operator terminals, supervision software and accessories

#### **FR Family**

Product catalogue for frequency inverters and accessories

#### **MR Family**

Product catalogue for servo amplifiers and servo motors as well as motion controller and accessories

#### **Robots Family**

Product catalogue for industrial robots and accessories

#### **LVS Family**

Product catalogue for low voltage switchgears, magnetic contactors and circuit breakers

#### **Automation Book**

Overview on all Mitsubishi Electric automation products, like frequency inverters, servo/motion, robots etc.

---

### **More information?**

This product catalogue is designed to give an overview of the extensive range of FX Family of MELSEC PLCs. If you cannot find the information you require in this catalogue, there are a number of ways you can get further details on configuration and technical issues, pricing and availability.

For technical issues visit the <https://eu3a.mitsubishielectric.com> website. Our website provides a simple and fast way of accessing further technical data and up to the minute details on our products and services. Manuals and catalogues are available in several different languages and can be downloaded for free.

For technical, configuration, pricing and availability issues contact our distributors and partners. Mitsubishi Electric partners and distributors are only too happy to help answer your technical questions or help with configuration building. For a list of Mitsubishi Electric partners please see the back of this catalogue or alternatively take a look at the "contact us" section of our website <https://eu3a.mitsubishielectric.com>.

### **About this product catalogue**

This catalogue is a guide to the range of products available. For detailed configuration rules, system building, installation and configuration the associated product manuals must be read. You must satisfy yourself that any system you design with the products in this catalogue is fit for purpose, meets your requires and conforms to the product configuration rules as defined in the product manuals.

Specifications are subject to change without notice. All trademarks acknowledged.

© Mitsubishi Electric Europe B.V., Factory Automation - European Business Group

**The products of Mitsubishi Electric Europe B.V., that are listed and described in this document, are neither subject to approval for export nor subject to the Dual-Use List.**

**System Description**

- ◆ ALPHA and MELSEC PLC system ..... 4
- ◆ Features FX series ..... 5
- ◆ Components for an FX PLC system ..... 6
- ◆ Calculation of the power consumption ..... 7

1

**1 ALPHA Controllers**

- ◆ Base units ..... 8
- ◆ Extension units and accessories ..... 11

2

**2 MELSEC FX Base Units**

- ◆ FX3S series ..... 13
- ◆ FX3G series ..... 16
- ◆ FX3GE series ..... 18
- ◆ FX3GC series ..... 20
- ◆ FX3U series ..... 23
- ◆ FX3UC series ..... 27

3

**3 MELSEC FX Extension Units**

- ◆ Powered compact extension units ..... 30
- ◆ Modular extension units without power supply ..... 31

4

**4 MELSEC FX Special Function Modules**

- ◆ Analog modules ..... 33
- ◆ Temperature control modules ..... 34
- ◆ Data logger modules ..... 36
- ◆ High-speed counter modules ..... 37
- ◆ Positioning modules ..... 38
- ◆ Network modules ..... 39
- ◆ Communications modules, Interface modules ..... 44
- ◆ Adapter boards and communications adapter ..... 46
- ◆ Interface adapters ..... 48

5

6

**5 Accessories**

- ◆ Expansion adapter/Memory media ..... 49
- ◆ External terminal blocks ..... 50
- ◆ Power supply units/Backup batteries ..... 52
- ◆ Cables ..... 53
- ◆ Display modules ..... 54

7

**6 Dimensions**

- ◆ ALPHA series ..... 55
- ◆ Base and extension units ..... 56
- ◆ Special function modules ..... 59
- ◆ Accessories ..... 61

**7 Software & Programming**

- ◆ Trainings and programming software ..... 62
- ◆ Programming unit ..... 65
- ◆ Approvals ..... 66
- ◆ Index ..... 68

## ALPHA and MELSEC PLC systems

### The ALPHA series

The ALPHA closes the gap between single components and a PLC system. It combines all advantages of a PLC system in a very compact housing and therefore provides a space and cost saving alternative to relays and contactors.

The ALPHA series is suited to applications in industrial machines and in automated building services.

Key enhancements in the ALPHA2 include a program capacity of 200 function blocks, an extra-large display, expansion options and a second communications port. The instruction set, includes math operations, PWM and SMS text messaging functions. All this opens up possibilities for analog and temperature control as well as remote operation.

### The MELSEC FX family

The MELSEC FX family includes a very comprehensive range of base and expansion modules, enabling you to configure a customised system tailored to your precise requirements.

Depending on your application and control needs you can choose between the small, attractively-priced, "stand-alone" MELSEC FX3S series, and the efficient FX3G, FX3GC, FX3GE, FX3U and FX3UC series.

With the exception of the FX3S all FX series can be expanded to adapt them to the changing needs of your installations and applications.

Network integration is also supported, making it possible for your FX controllers to communicate with other PLCs, controllers and HMIs.

The PLC systems can be configured as local stations in Mitsubishi Electric networks. In addition these flexible units can also be used as master or slave units on fieldbus's like Profibus DP and CC-Link.

The MELSEC FX Family controllers also support CANopen, DeviceNet, Ethernet or J1939 (NMEA 2000).

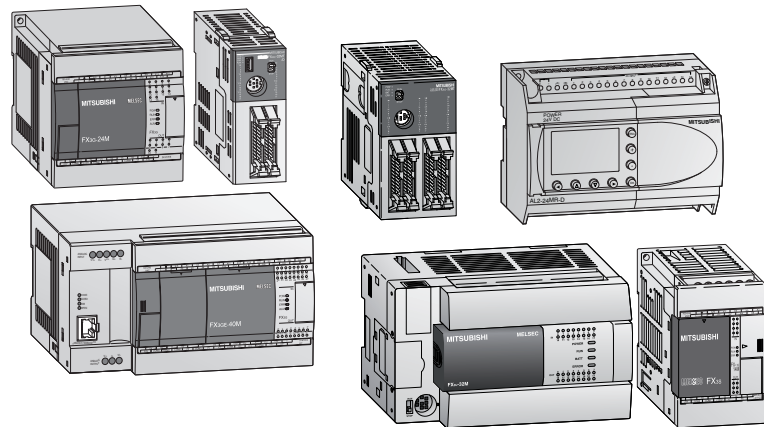

### Expandability and power

The MELSEC FX family is highly flexible, enabling fast and efficient configuration and programming for the application at hand.

It is the ideal choice, no matter whether you need to install a simple control application requiring 10 I/Os (FX3S) or a demanding, complex system with up to 384 I/O points (FX3U).

The use of memory cassettes can expand the available programming space on some FX Family PLCs while generally providing a long term program storage option for all FX PLC users. In addition, memory cassettes can also allow programs to be switched at very short notice simply by replacing the cassette.

There are six series in the MELSEC FX family, each of which is designed for a different application profile:

- **The FX3S series**

The MELSEC FX3S-series is the inexpensive entry to the MELSEC FX family and with its small dimensions it is also an excellent alternative to relay and contactor configurations.

- **The FX3G series**

The FX3G is an introductory compact PLC and is designed for simple yet performance-critical applications. Incorporating innovative FX3 series technology the customer is presented with a suite of benefits.

- **The FX3GE series**

The FX3GE series provides the advantages and expandability of the FX3G series and in addition a built-in Ethernet interface as well as two integrated analog inputs and one analog output.

- **The FX3GC series**

The performance of the FX3GC is the same as that of the FX3G series. Due to its plug-in connectors for I/O signals it has even more compact dimensions.

- **The FX3U/FX3UC series**

The FX3U series gives you the freedom of modular expandability, with a wide selection of expansion modules and special function modules.

The FX3U is the fastest PLC system available, with a cycle time of just 0.065  $\mu$ s per logical instruction. This gives users a powerful CPU delivering modular PLC performance in a compact PLC design.

The performance of the FX3UC is the same as that of the FX3U series, but it has more compact dimensions. It is the ideal choice for applications where little space is available for the controller.

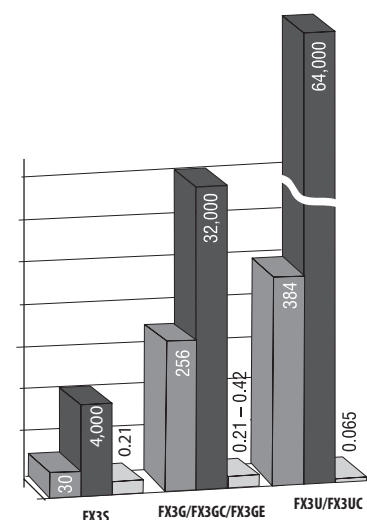

■ No. of inputs/outputs

■ Cycle time ( $\mu$ s)

■ Program steps

\* Available with optional cassette

## Features

The modular design of the MELSEC FX family makes it extremely flexible, enabling it to be used for a very broad range of applications.

You can configure tailor-made systems by combining modules from a variety of different categories (see figure).

All modules are electrically isolated from their environment with optocouplers for maximum reliability.

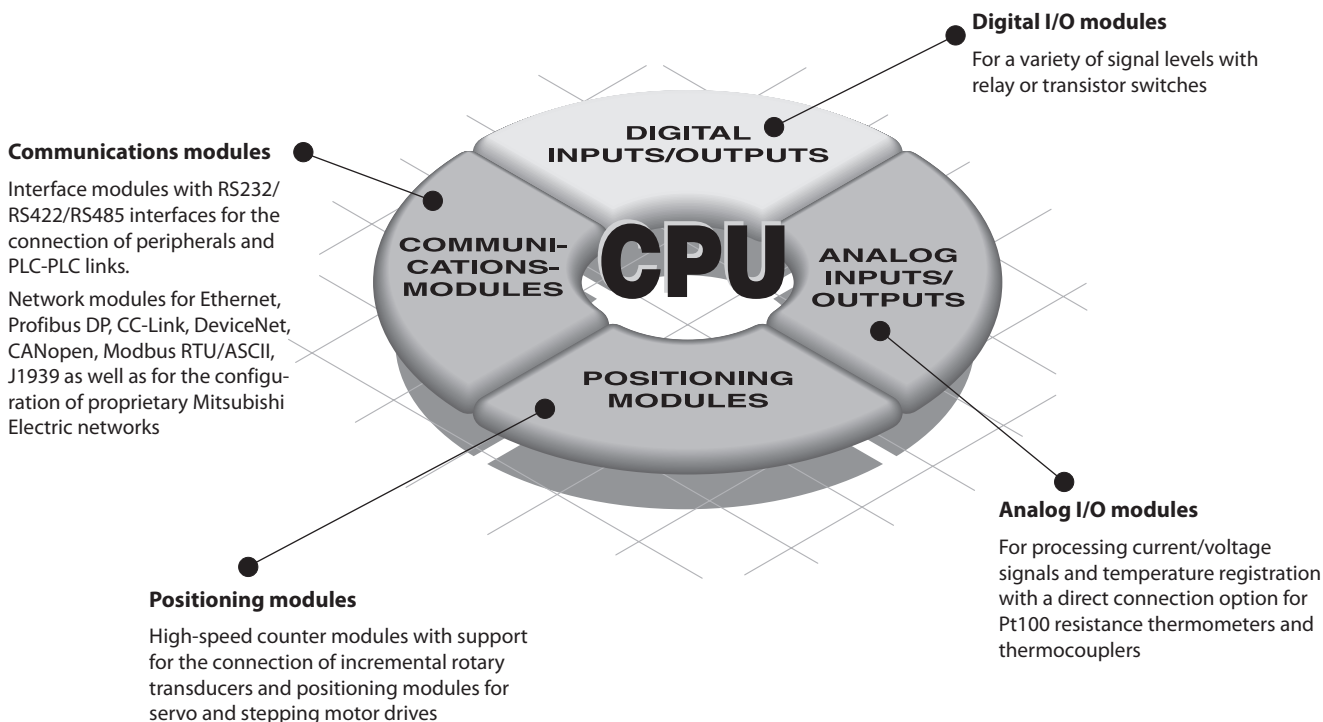

### Digital and special function modules – configuration

The options for using digital and special function modules are dictated by the CPU used in the system.

When calculating the number of special function modules you can use in a system you must take both the number of digital modules and the maximum number of special function modules that can be used into account.

The table on the right provides a simplified guide to the number of modules you can use in each system type. More detailed information and the basic principles of system configuration can be found in the corresponding manuals.

CPU type	System restrictions
FX3S	Stand-alone PLC with 10/14/20 or 30 I/Os It is not possible to connect special function modules on the right side of the base unit. On the left side of the base unit a communication adapter module and an analog adapter module of the FX3U series can be connected. Furthermore an extension adapter can be installed directly in the base unit.
FX3G	PLC with max. 256 I/Os A maximum of 8 special function modules and digital extension modules with up to 128 I/Os can be connected to the right side of the main unit. In addition, a maximum of 4 adapters from the FX3U series can be connected to the left side.
FX3GC	PLC with max. 256 I/Os At the left side of the base unit up to two communications adapters as well as maximal two analog I/O adapters of the FX3U series can be connected. On the right side of the base unit up to 8 special function modules and digital extension modules can be connected with up to 128 inputs and outputs.
FX3GE	PLC with max. 256 I/Os At the left side of the base unit one communications adapter and one analog I/O adapter of the FX3U series can be connected. On the right side of the base unit up to 8 special function modules and digital extension modules can be connected with up to 128 inputs and outputs.
FX3U	PLC with max. 384 I/Os To the left side of the main unit, a maximum of 10 adapters from the FX3U series can be connected. To the right side of the main unit, up to 8 special function modules and digital extension modules with up to 256 I/Os can be connected.
FX3UC	SPS mit max. 384 Ein-/Ausgängen To the left side of the main unit, a maximum of 6 adapters from the FX3U series can be connected. To the right side of the main unit, up to 4 special function modules and digital extension modules with up to 256 I/Os can be connected.

## What components are required for an FX PLC system?

A basic FX PLC system can consist of a stand-alone base unit, with the functionality and I/O range increased by adding extension I/O and special function modules. The following section provides an overview of options available.

### Base units

The entire FX PLC range can be AC or DC powered with a mix of input and output styles. The PLCs can be programmed with the user friendly GX Works2 programming software, allowing programs to be transferred between different FX PLCs. All PLC base units include an integrated real time clock.

Base units are available with different I/O configurations from 10 to 128 points but can be expanded to 384 points depending upon the FX range selected.

### Extension boards

Except for the FX3GC and FX3UC series, extension adapter boards can be installed directly into the base unit and therefore do not require any additional installation space. For a small number of I/O (2 to 4) an extension adapter board can be installed directly into the FX3S, FX3G, FX3GE or FX3U controller. Interface adapter boards can also provide the FX PLC with additional RS232, RS422, RS485 or USB interfaces. To connect adapter modules (e.g. Ethernet module) a communication adapter has to be installed (except FX3UC).

### Extension I/O modules

Unpowered and powered extension I/O modules can be added to the FX3G, FX3GC, FX3GE, FX3U and FX3UC PLCs.

For expansion modules powered by the base unit, the power consumption has to be calculated as the 5 V DC bus can only support a limited number of expansion I/O (for further details please refer to next page – calculation of the power consumption).

### Special function modules

A wide variety of special function modules are available for the FX3G, FX3GC, FX3GE, FX3U and FX3UC PLCs. They cover networking functionality, analog control, pulse train outputs, data logging function and temperature inputs.

### Memory extension and operator terminals

Each FX family base unit (except FX3GC) can be equipped with a memory cassette. The programming unit interface enables the connection of programming tools like PC and hand held programming units as well as graphical operator terminals.

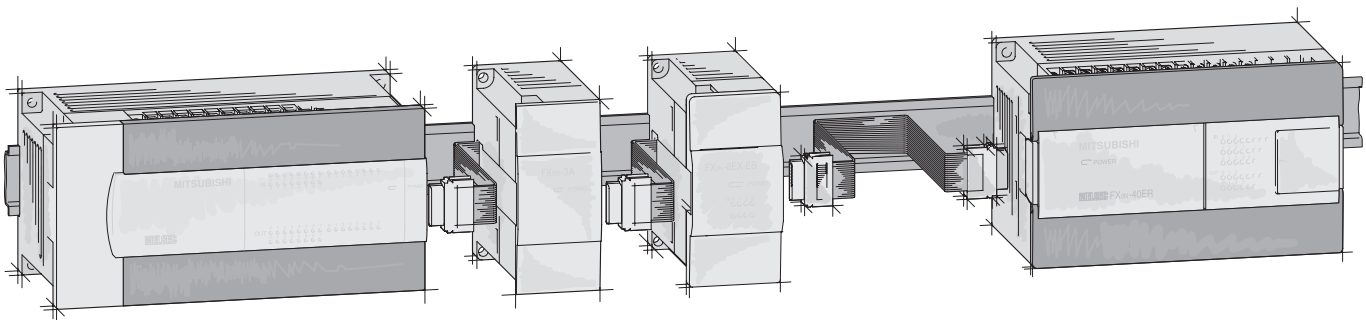

Expansion possibilities		ALPHA 2	FX3S	FX3G	FX3GC	FX3GE	FX3U	FX3UC	Reference page
Extensions for inside PLC installation	Digital	●	—	●	—	—	●	●	11
	Analog	●	●	●	—	●	●	●	11, 44
Extension modules (installation outside the PLC)	Digital	—	—	●	—	●	●	●	30
	Analog	—	●	●	●	●	●	●	33
	Temperature	●	●	●	●	●	●	●	11, 34
Network modules	Ethernet	—	●	●	●	●	●	●	40
	CC-Link	—	—	●	●	●	●	●	40
	CANopen	—	—	●	●	●	●	●	43
	Profibus DP	—	—	●	●	●	●	●	41
	DeviceNet	—	—	●	●	●	●	●	43
	Modbus RTU/ASCII	—	—	●	●	●	●	●	44
	SSCNET	—	—	—	—	—	●	●	38
	J1939	—	—	●	●	●	●	●	44
Communications boards	RS232	●	●	●	—	●	●	—	46
	RS422	—	—	●	—	●	●	—	46
	RS485	—	●	●	—	●	●	—	46
	USB	—	—	—	—	—	●	—	48
Communications modules	RS232	—	—	●	●	●	●	●	43
	RS485	—	—	●	●	●	●	●	43
Dedicated function modules	High speed counter	—	—	—	—	—	●	●	36
	Positioning	—	—	—	—	—	●	●	38
Memory cassettes	●	●	●	—	●	●	●	●	12, 49
External display	—	—	●	—	●	●	—	—	54



## Calculation of the power consumption

The power consumption figures on the 5 V DC bus for the special function modules are shown in the specifications tables on the following pages.

The maximum permissible currents on the 5 V DC and 24 V DC bus are shown in the table below.

Modules	Max. current	
	5 V bus	24 V bus
FX3G-14/24M□-ES(ESS)	—	400 mA
FX3G-40/60M□-ES(ESS)	—	400 mA
FX3U-16/32M□-ES(ESS)	500 mA	400 mA
FX3U-48-128M□-ES(ESS)	500 mA	600 mA
FX3UC-16MT/D(DSS)	600 mA	—
FX3UC-32MT/D(DSS)	560 mA	—
FX3UC-64MT/D(DSS)	480 mA	—
FX3UC-96MT/D(DSS)	400 mA	—

The residual currents for the 24 V DC service voltage at different input/output configurations are shown in the tables on the right.

A maximum of 256 I/Os are possible for FX3U/ FX3UC (128 I/Os for FX3G/FX3GC/FX3GE).

Max. residual current values (in mA) for FX3U-16M□/E□□ through FX3U-32M□/E□□ for the permissible configuration

Number of additional outputs	40	25												
	32	100	50	0										
	24	175	125	75	25									
	16	250	200	150	100	50	0							
	8	325	275	225	175	125	75	25						
	0	400	350	300	250	200	150	100	50	0				
	<b>0</b>	<b>8</b>	<b>16</b>	<b>24</b>	<b>32</b>	<b>40</b>	<b>48</b>	<b>56</b>	<b>64</b>					
Number of additional inputs														

Max. residual current values (in mA) for FX3U-48M□/E□□ through FX3U-128M□/E□□ for the permissible configuration

Number of additional outputs	64	0																
	56	75	25															
	48	150	100	50	0													
	40	225	175	125	75	25												
	32	300	250	200	150	100	50	0										
	24	375	325	275	225	175	125	75	25									
	16	450	400	350	300	250	200	150	100	50	0							
	8	525	475	425	375	325	275	225	175	125	75	25						
	0	600	550	500	450	400	350	300	250	200	150	100	50	0				
		<b>0</b>	<b>8</b>	<b>16</b>	<b>24</b>	<b>32</b>	<b>40</b>	<b>48</b>	<b>56</b>	<b>64</b>	<b>72</b>	<b>80</b>	<b>88</b>	<b>96</b>				
Number of additional inputs																		

## Sample calculations

The tables below and on the right show different examples for sample power calculation for a PLC system.

The current values for the special function modules can be found in the specifications on the following pages.

Comparison with the current value tables show that the calculated figures for the 5 V bus lie within the allowable ranges.

In the example below all units can be supplied sufficiently with the internal 24 V power supply.

Module	No.	24 V DC calculation		5 V DC calculation	
		Current/module	Calculation	Current/module	Total current
FX3U-80MR/ES	1	600 mA	+600 mA	+500 mA	+500 mA
FX3U-4AD	2	90 mA	-180 mA	110 mA	-220 mA
FX3U-4DA	2	160 mA	-320 mA	120 mA	-240 mA
FX3U-ENET	1	240 mA	-240 mA	—	—
			<b>-140 mA !!!</b>		<b>500-460 mA</b>
				Result:	<b>40 mA (OK !)</b>

An external 24 V power supply has to be added in the example above.

Module	No.	Number of I/Os			24 V DC calculation		5 V DC calculation		
		X	Y	X/Y	Total ①	Total current ②	Current/module	Total current	
FX3U-48MR/ES	1	24	24	—	X = 8 Y = 24 →	+325 mA	500 mA	+500 mA	
FX2N-16EYR-ES/UL	1	—	16	—			—	0 mA	
FX2N-8EX-ES/UL	1	8	—	—			—	0 mA	
FX2N-8EYR-ES/UL	1	—	8	—			—	0 mA	
FX3U-4AD-PT-ADP	1	—	—	—			-50 mA	30 mA	-15 mA
						<b>+275 mA (OK!)</b>		<b>+485 mA (OK!)</b>	
FX2N-32ER-ES/UL	1	16	16	—	X = 16 Y = 0 →	+150 mA residual current for extension unit FX2N-32ER-ES/UL	690 mA	+690 mA	
FX2N-16EX-ES/UL	1	16	—	—			0 mA	—	0 mA
FX2N-10PG	1	—	—	8			-50 mA	120 mA	-120 mA
FX2N-32CCL	1	—	—	8			-50 mA	130 mA	-130 mA
					Result:	<b>64 + 64 + 16 = 144! (&lt; 256) OK!</b>		<b>+100 mA (OK!)</b>	
								<b>+440 mA (OK!)</b>	

① Total no. of I/Os which are connected to a base unit to calculate the max. residual current values (see tables)

② see tables above (max. residual current values)

**The ALPHA 2 series**

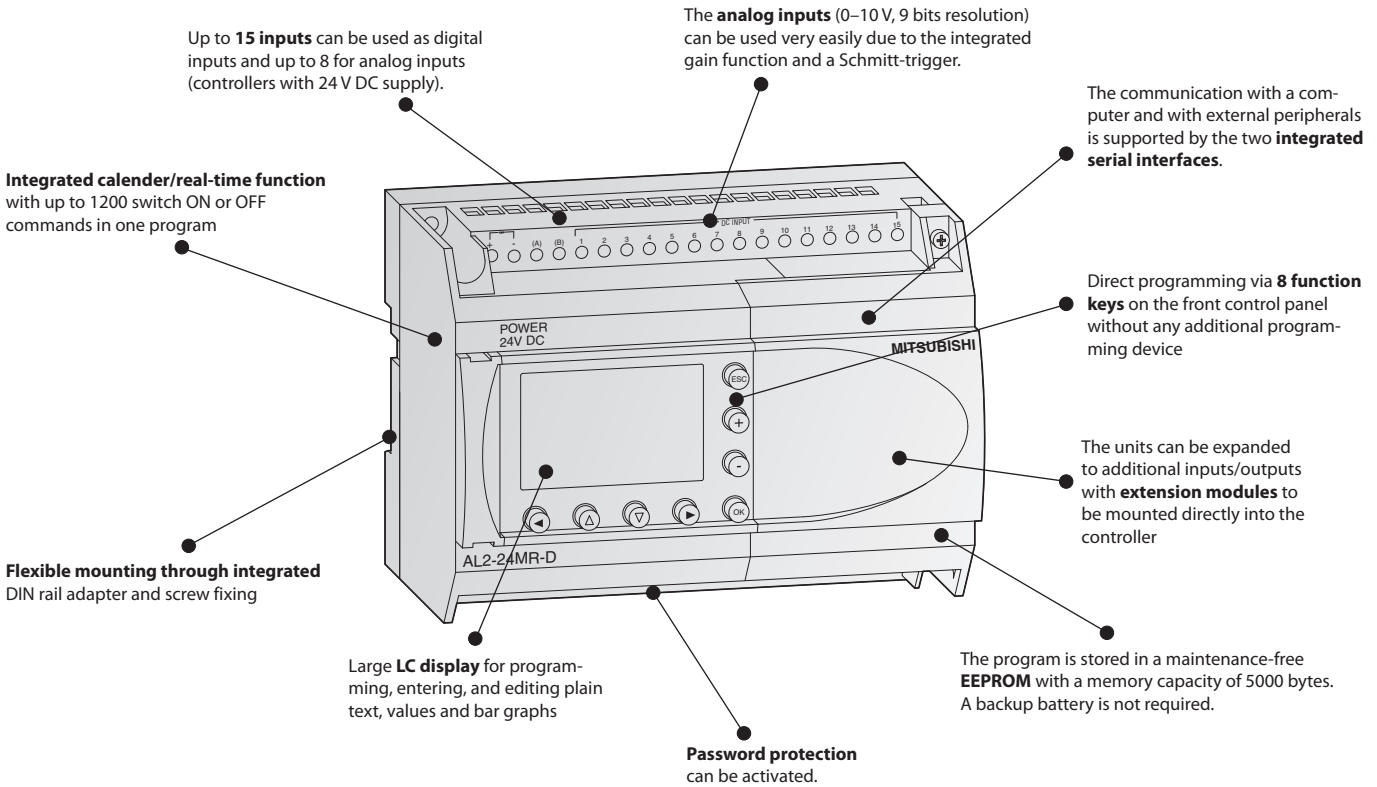

**Description of the unit components**

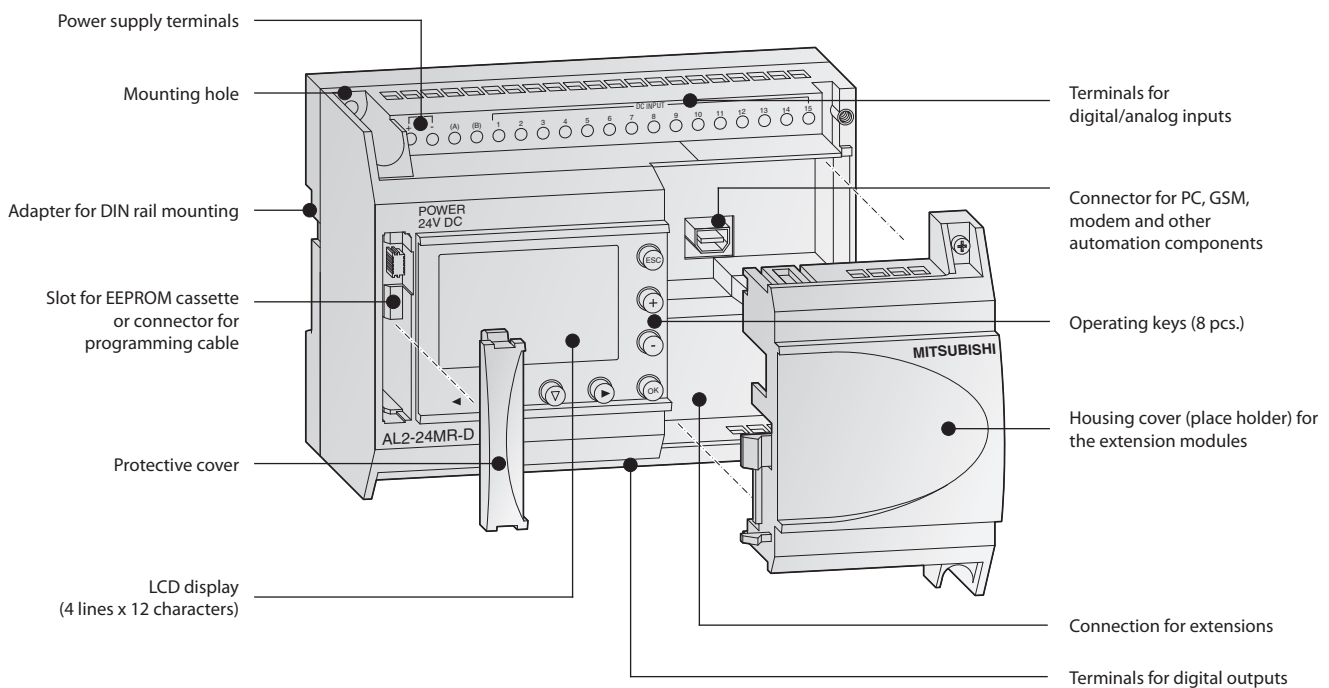

## Specifications ALPHA 2

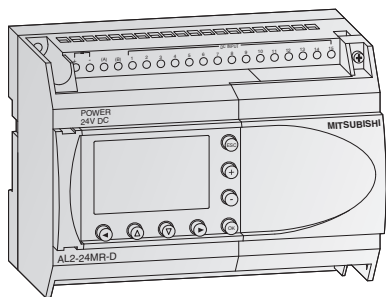

e.g. AL2-24MR-D

### ALPHA 2 base units

The ALPHA 2 controllers offer simple reliable control for a range of automation applications including lighting, air conditioning, security systems, and temperature and water control.

- Transistor and relay output options
- Analog input/output
- High speed counters up to 1 kHz
- GSM function for communication with mobile phones
- Language support for 8 different languages
- Display unit for messages and function block data

## Base units with 10–24 I/Os

Specifications		AL2-10MR-A	AL2-10MR-D	AL2-14MR-A	AL2-14MR-D	AL2-24MR-A	AL2-24MR-D
<b>Electrical specifications</b>							
Integrated inputs/outputs		10	10	14	14	24	24
Power supply		100–240 V AC	24 V DC	100–240 V AC	24 V DC	100–240 V AC	24 V DC
Digital inputs		6	6	8	8	15	15
Analog inputs		—	6	—	8	—	8
Channels		—	6	—	8	—	8
Integrated outputs		4	4	6	6	9	9
Max. power consumption	W	4.9	4.0	5.5	7.5	7.0	9.0
Typ. power consumption	all I/Os	3.5/1.85	2.5/0.75	4.5/2.0	4.0/1.0	5.5/2.5	5.0/1.0
	ON/OFF	240 V AC	120 V AC	240 V AC	120 V AC	240 V AC	120 V AC
Weight	kg	0.2	0.2	0.3	0.3	0.35	0.3
Dimensions (WxHxD)	mm	71.2x90x55	71.2x90x55	124.6x90x52	124.6x90x52	124.6x90x52	124.6x90x52
<b>Order information</b>	Art. no.	215070	215071	215072	215073	215074	215075
<b>Accessories</b>	Power supplies with DIN-rail or wall mounting possibility for powering the 24 V DC modules (refer to the power supply chapter in this catalogue); IP40 mounting frame AL2-FRAME-14/24-IP40, art. no.: 231366; IP54 mounting frame AL2-FRAME-14/24-IP54, art. no.: 231368 for AL2-14/24 IP40 mounting frame AL2-FRAME-10-IP40, art. no.: 231365; IP54 mounting frame AL2-FRAME-10-IP54, art. no.: 231367 for AL2-10						

## Environmental specifications

General specifications	Alpha 2 series
Ambient temperature	Display: -10–55 °C, Hardware: -25–55 °C (storage temperature: -30–+70 °C)
Protection rating	IP20
Noise immunity	1000 Vpp with noise generator; 1 µs at 30–100 Hz, tested by noise simulator
Dielectric withstand voltage	3750 V AC, >1 min. according to EN 60730
Allowable relative humidity	35–85 % (no condensation)
Shock resistance	Acc. to IEC 68-2-27: 147 m/s <sup>2</sup> acceleration, 11 ms 3x3 directions
Vibration resistance	direct mounting
	DIN rail mounting
Insulation resistance	500 V DC, 7 MΩ acc. to EN60730-1
Ambient conditions	No corrosive gases, no dust
Certifications	Please refer to pages 66–67 in this catalogue

## Electrical specifications

Power supply specifications	DC powered modules (AL2-□MR-D)	AC powered modules (AL2-□MR-A)
Power supply	24 V DC	100–240 V AC (50/60 Hz)
Inrush current at ON	≤7.0 A (at 24 V DC)	≤6.5 A (at 240 V AC)
Allowable momentary power failure time	5 ms	10 ms

### Digital Inputs

Input voltage	24 V DC (+20 %/-15 %)	100–240 V AC (+10 %/-15 %), 50/60 Hz
Input current	The input current changes depending on Source or Sink.	
	For Sink: (AL2-10/14/24MR-D) = 5.5 mA, 24 V DC For Source: (AL2-10/14MR-D) = 6.0 mA, 24 V DC (AL2-24MR-D) = 5.5 mA, 24 V DC	101–108 0.13 mA/120 V AC* 0.25 mA/240 V AC* 109–115 0.15 mA/120 V AC* 0.29 mA/240 V AC*
Response time	OFF→ON	ms 10–20
	ON→OFF	ms 10–20

### Analog Inputs

Analog input range	0–500	—
Resolution	9 bit, (10 V/500)	—
Conversion speed	ms 8	—
Voltage	0–10 V DC	—
Impedance	kΩ 142 ±5 %	—
Accuracy	±5 % (0.5 V DC)	—

\* Current leakage from the sensors connected to the inputs might provide enough current to turn the controller ON. Do not use two wire sensors.

Output specifications	All modules
Type	Relay
Switching voltage (max.)	V 250 V AC, 30 V DC
Rated current	10M, 14M: 8 A/point
	24M (001-004): 8 A/point
	24M (005-009): 2 A/point
Max. switching load	- inductive load 14M, 24M: 249 VA, 250 V AC/373 VA, 250 V AC 24M: 93 VA, 125 V AC/93 VA, 250 V AC
Minimum load	10 mA, 5 V DC
Response time	ms ≤10

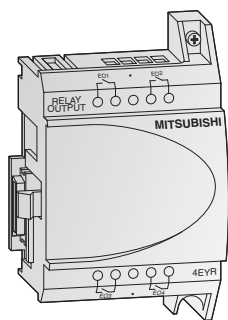

### Digital extension modules

There are 4 different extension modules available for the ALPHA 2, which allow the controller to be extended through additional inputs or outputs. The modules are inserted directly into the ALPHA 2 and therefore do not take up any additional space.

The AL2-4EX has the additional feature that 2 inputs may be used as high-speed counters with a counting frequency of 1 kHz.

All modules feature photocoupler insulation for all I/Os.

Digital extension modules specifications		AL2-4EX-A2	AL2-4EX	AL2-4EYR	AL2-4EYT
<b>Inputs</b>					
Integrated inputs		4	4	—	—
Input voltage		220–240 V AC	24 V DC (+20 %, -15 %)	—	—
Input current		7.5 mA at 240 V AC (50 Hz), 9.0 mA at 240 V AC (60 Hz)	5.4 mA ±1 mA at 24 V DC	—	—
<b>Outputs</b>					
Integrated outputs		—	—	4	4
Output type		—	—	Relay	Transistor
Switched voltage (max.)	V	—	—	250 V AC, 30 V DC	5–24 V DC
Rated current	A	—	—	2 A per output	1 A per output
<b>Electrical specifications</b>					
Power Supply	AC range (+10 %, -15 %)	220–240 V AC	24 V DC	100–240 V AC	24 V DC
<b>Mechanical specifications</b>					
Weight	kg	0.05	0.05	0.05	0.05
Dimensions (WxHxD)	mm	53.1x90x24.5	53.1x90x24.5	53.1x90x24.5	53.1x90x24.5
<b>Order information</b>		Art. no. 142522	142521	142523	142524

Note: I1 and I2 of the AL2-4EX can be used as high-speed counter inputs. In each case the response time for the high-speed counter inputs will be 0.5 ms or less. The AL2-4EX-A2, AL2-4EX, AL2-4EYR and AL2-4EYT modules can not be used with the AL2-10MR series.

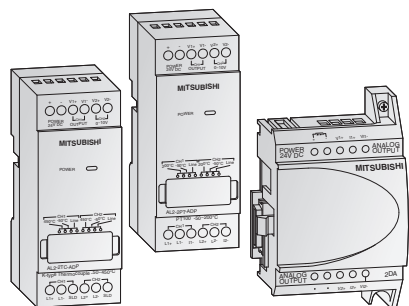

### Analog extension modules

The analog extension modules significantly increase the range of applications for the ALPHA 2. With these modules it is possible to output voltage or current signals or to measure temperatures.

Three different analog extension modules are available:

- The AL2-2DA offers two additional analog outputs for the ALPHA 2 and converts a digital input value into a voltage or a current. This module is inserted directly into the ALPHA 2.
- The AL2-2PT-ADP connects an external PT100 sensor to convert temperature readings into analog signals (0–10 V).
- The AL2-2TC-ADP connects thermocouple sensors (K type) to convert temperature readings into analog signals (0–10 V).

Analog extension modules specifications		AL2-2DA	AL2-2PT-ADP	AL2-2TC-ADP
<b>Analog inputs</b>				
Integrated inputs		—	2	2
Connectable temperature sensors		—	Pt100 sensor Temp. coefficient 3.850 ppm/°C (IEC 751)	Thermocouple (K type), isolated type (IEC 584-1 1977, IEC 584-2 1982)
Compensated range		—	-50–+200 °C	-50–+450 °C
<b>Analog outputs</b>				
Integrated outputs		2	—	—
Analog output range	voltage	0–10 V DC (5 kΩ–1 MΩ)	—	—
	current	4–20 mA (max. 500 Ω)	—	—
<b>Electrical specifications</b>				
Number of channels		2	2	2
Power Supply		24 V DC (-15–+10 %), 70 mA	24 V DC (-15–+20 %), 1 W	24 V DC (-15–+20 %), 1 W
<b>Mechanical specifications</b>				
Weight	kg	0.05	0.07	0.07
Dimensions (WxHxD)	mm	53.1x90x24.5	35.5x90x32.5	35.5x90x32.5
<b>Order information</b>		Art. no. 151235	151238	151239

Note: the AL2-2DA module can not be used with the AL2-10MR series

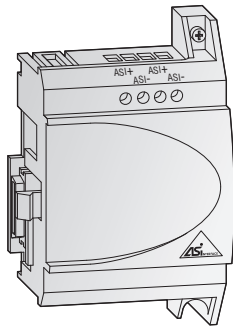

**AS-Interface module AL2-ASI-BD**

The Actuator Sensor Interface module AL2-ASI-BD in combination with an ALPHA 2 controller facilitates the data communications via an AS-Interface system. The AL2-ASI-BD is attached to an ALPHA 2 series module and forms a slave unit. Up to 4 inputs and 4 outputs can be exchanged with the AS-Interface master.

The addresses of the slave devices in the AS-Interface are assigned either automatically via the master in the network or via a programming device (software).

The maximum communication distance is 100 m without a repeater. If 2 repeaters are used, the distance is extended to up to 300 m.

For the AS-Interface a separate power supply is required. The communication signal is superimposed on the power supply of the AS-Interface bus.

Note: The AL2-ASI-BD cannot be used with the AL2-10MR series.

Specifications		AL2-ASI-BD
Module type		Slave module
Number of I/O points		4 inputs, 4 outputs
External power supply		30.5 V DC (AS-Interface power supply)
External current consumption	mA	Max. 40
Communications protocol		AS-Interface standard
Weight	kg	0.05
Dimensions (WxHxD)	mm	53.1x90x24.5
<b>Order information</b>		Art. no. 142525

Note: The AL2-ASI-BD cannot be used with the AL2-10MR series.

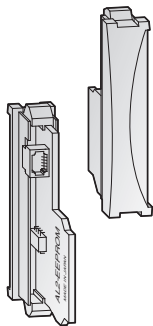

**Memory cassette AL2-EEPROM-2 memory media**

With the AL2-EEPROM-2 memory cassettes, a new program can be transferred to the ALPHA 2 controller's internal system memory from the cassette, or the program of the internal system memory can be saved to the cassette.

If the memory cassette is used, a certain program can be run temporarily by simply plugging the external memory module onto the ALPHA 2.

After removing the memory cassette, the former program in the internal memory becomes active again.

The memory cassette AL2-EEPROM-2 is not a memory expansion device, but a medium for data exchange.

Specifications		AL2-EEPROM-2
Memory type		EEPROM
Application		ALPHA 2
Memory capacity		5,000 bytes
Function blocks		Max. 200
Dimensions (WxHxD)	mm	10x45x25
<b>Order information</b>		Art. no. 142526

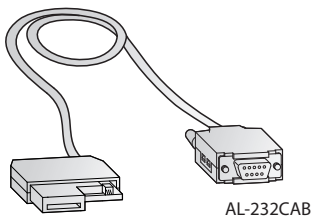

AL-232CAB

**Interface Cable AL-232CAB**

The AL-232CAB is an RS232C interface cable. It connects the ALPHA 2 controller to a personal computer running the programming software for the ALPHA 2 controller.

The cable ensures a galvanic isolation between the ALPHA 2 controller and the personal computer. The cable AL-232CAB can not be used for any other connection.

**GSM Cable AL2-GSM-CAB**

The GSM AL2-GSM-CAB is an RS232C interface cable and it is used to connect the ALPHA 2 controller to a normal or GSM modem, a personal computer or other serial devices. It can transfer SMS data to a GSM modem for onward transmission to mobile telephones or e-mail addresses. It also permits remote monitoring and remote maintenance.

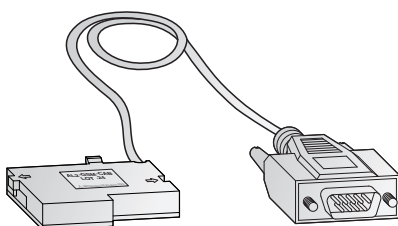

AL2-GSM-CAB

Specifications		AL-232CAB	AL2-GSM-CAB
Connector		9-pin D-SUB female connector	9-pin D-SUB male connector
Application		ALPHA 2 <-> PC	ALPHA 2 <-> PC, modem
Length	m	2.5	1.5
<b>Order information</b>		Art. no. 87674	142528

Note: The above cables cannot be used with the AL2-10MR series.

### The MELSEC FX3S series

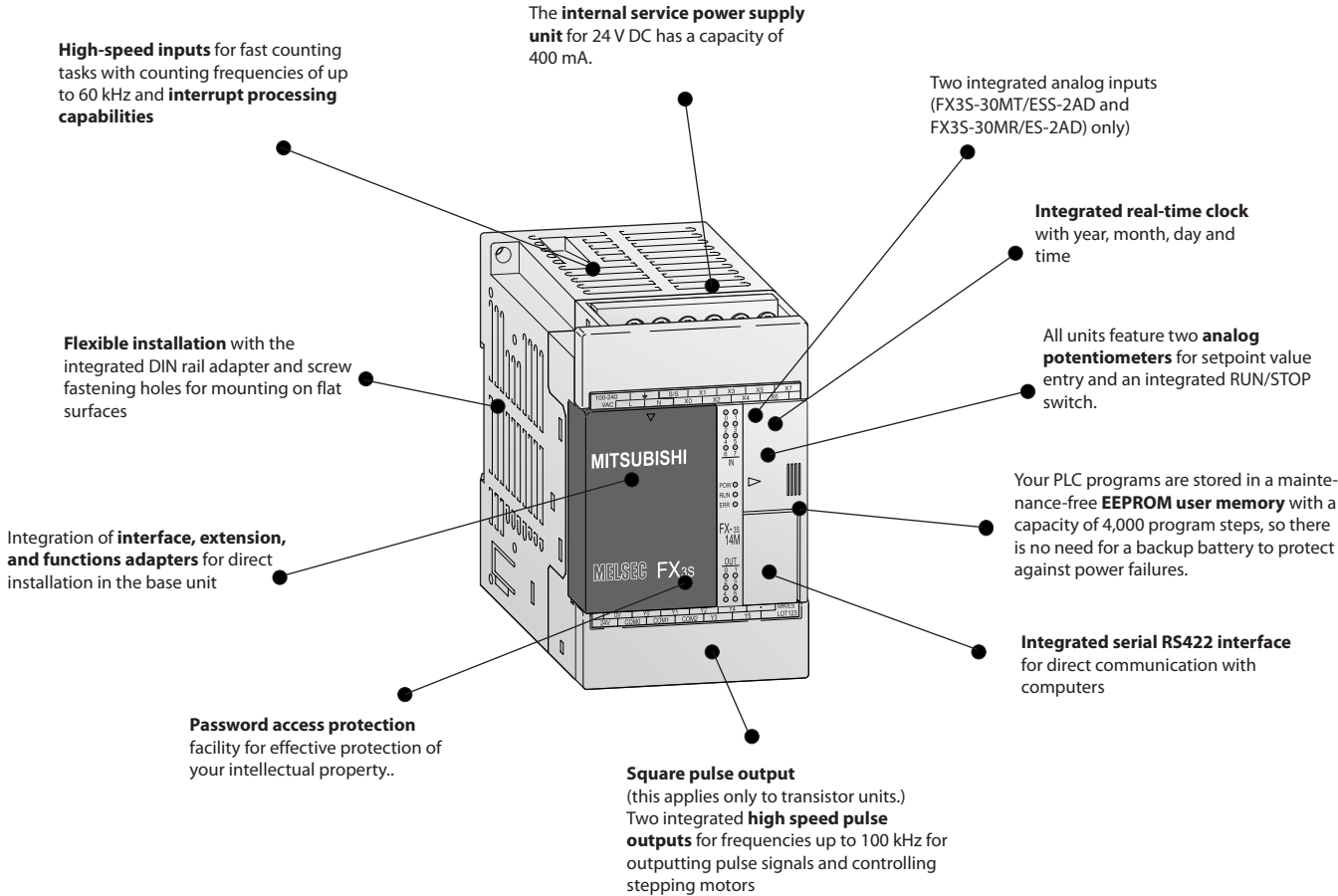

2  
FX Base Units

### Description of the unit components

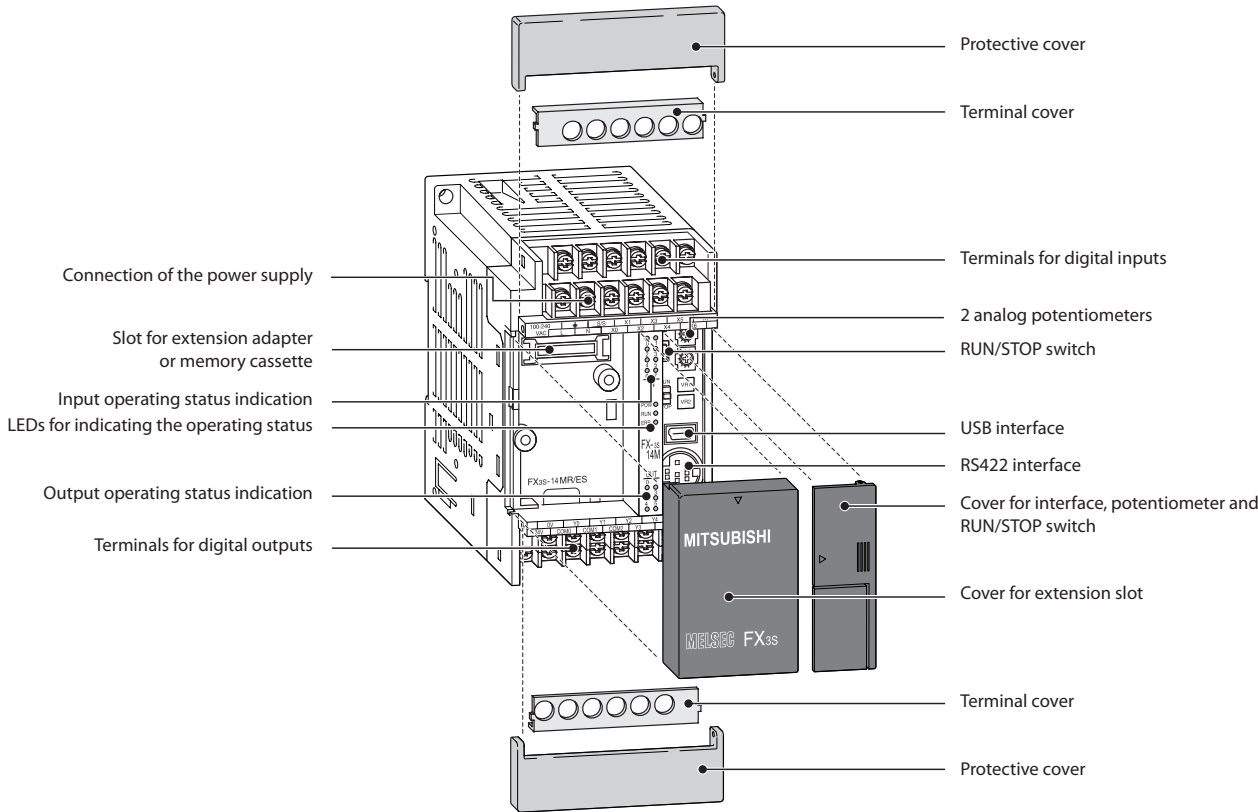

■ Base units  FX3S  FX3G  FX3GC  FX3GE  FX3U  FX3UC

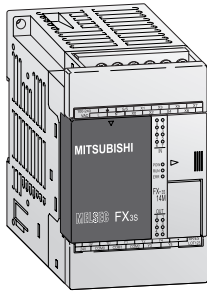

**Base units FX3S**

The FX3S series base units are available with 10 to 30 input/output points.

It is possible to choose between relay and transistor output type.

- Integrated power supply (AC or DC powered)
- Maintenance-free EEPROM memory
- Ample memory capacity (4000 steps) and device ranges
- High-speed operations
- Incorporated positioning control
- Integrated real-time clock
- FX3S-30MT/ESS-2AD and FX3S-30MR/ES-2AD with two integrated analog inputs (0–10V DC)
- System upgrades by exchangeable interface and I/O adapter boards for direct fitting into the base unit
- LEDs for indicating the input and output status
- Standard programming unit interface
- User-friendly programming systems, including IEC 61131-3 (EN 61131-3)-compatible programming software, HMIs and hand-held programming units

**Base units with 10–14 I/Os**

Specifications	FX3S-10 MR-ES	FX3S-10 MR-DS	FX3S-10 MT-ESS	FX3S-10 MT/DSS	FX3S-14 MR-ES	FX3S-14 MR-DS	FX3S-14 MT-ESS	FX3S-14 MT/DSS	
Max. number inputs/outputs	10	10	10	10	14	14	14	14	
Power supply	100–240 V AC	24 V DC	100–240 V AC	24 V DC	100–240 V AC	24 V DC	100–240 V AC	24 V DC	
Integrated inputs	6	6	6	6	8	8	8	8	
Integrated outputs	4	4	4	4	6	6	6	6	
Output type	Relay	Relay	Transistor (source)	Transistor (source)	Relay	Relay	Transistor (source)	Transistor (source)	
Power consumption	W	19	6	19	6	19	6,5	19	6,5
Weight	kg	0.30	0.30	0.30	0.30	0.30	0.30	0.30	0.30
Dimensions (WxHxD)	mm	60x90x75	60x90x49	60x90x75	60x90x49	60x90x75	60x90x49	60x90x75	60x90x49
<b>Order information</b>	Art. no.	267110	271687	267112	271695	267113	271688	267125	271696

**Base units with 20–30 I/Os**

Specifications	FX3S-20 MR-ES	FX3S-20 MR-DS	FX3S-20 MT-ESS	FX3S-20 MT/DSS	FX3S-30 MR-ES	FX3S-30 MR-DS	FX3S-30 MR-ES-2AD	FX3S-30 MT-ESS	FX3S-30 MT-ESS-2AD	FX3S-30 MT/DSS	
Max. number inputs/outputs	20	20	20	20	30	30	30	30	30	30	
Power supply	100–240 V AC	24 V DC	100–240 V AC	24 V DC	100–240 V AC	24 V DC	100–240 V AC	100–240 V AC	100–240 V AC	24 V DC	
Integrated inputs	12	12	12	12	16	16	16	16	16	16	
Integrated outputs	8	8	8	8	14	14	14	14	14	14	
Output type	Relay	Relay	Transistor (source)	Transistor (source)	Relay	Relais	Relais	Transistor (source)	Transistor (source)	Transistor (source)	
Power consumption	W	20	7	20	7	21	8,5	21	21	8,5	
Weight	kg	0.40	0.40	0.40	0.40	0.45	0.45	0.45	0.45	0.45	
Dimensions (WxHxD)	mm	75x90x75	75x90x49	75x90x75	75x90x49	100x90x75	100x90x49	100x90x75	100x90x75	100x90x49	
<b>Order information</b>	Art. no.	267126	271689	267128	271697	267129	271690	271654	267131	271686	271698



## Specifications

 FX3S  FX3G  FX3GC  FX3GE  FX3U  FX3UC

### Environmental specifications

General specifications	Data
Ambient temperature	0–55 °C (storage temperature: -25–+75 °C)
Noise durability	1,000 Vpp with noise generator; 1 μs at 30–100 Hz
Dielectric withstand voltage	1,500 V AC, 1 min
Ambient relative humidity	5–95 % (non-condensing)
Shock resistance	Acc. to IEC 68-2-27: 15 g (147m/s <sup>2</sup> ) (3 times each in 3 directions for 11 ms)
Vibration resistance	Acc. to IEC 68-2-6: 1 g (Resistance to vibrations from 57–150 Hz for 80 minutes along all 3 axes); 0.5G for DIN rail mounting
Insulation resistance	5 MΩ at 500 V DC
Ground	Class D: Grounding resistance 100 Ω or less
Fuse rating	250 V 1.0 A
Environment	Avoid environments containing corrosive gases, install in a dust-free location.
Certifications	Please refer to pages 66–67

### Electrical specifications

Power supply specifications	AC powered modules (FX-3S-□M□/E□)
Power supply	100–240 V AC (+10 %/-15 %), 50/60 Hz
Inrush current at ON	30 A / <5 ms (at 100 V AC); 50 A / <5 ms (at 200 V AC)
Allowable momentary power failure time	10 ms
Primary power supply	—
External power supply (24 V DC)	400 mA

Output specifications	Relay-Module	Transistor-Module
Switching voltage (max.)	V <240 V AC, <30 V DC	5–30 V DC
Max. output current	- per output A	0.5
	- per group <sup>②</sup> A	0.8
Max. switching current	- inductive load	12 W
		80 VA
Response time	ms 10	<0.2 (<5 μs for Y0,Y1)
Life of contacts (switching times) <sup>①</sup>		3,000,000 at 20 VA; 1,000,000 at 35 VA; 200,000 at 80 VA

<sup>①</sup> Not guaranteed by Mitsubishi Electric

<sup>②</sup> The limitation applies only per reference terminal for each group with 4 outputs. Please observe the terminal assignments for the group identification

### Programming specifications

System specifications	FX3S
<b>Program data</b>	
I/O points (addresses)	Max. 16 inputs, max 14 outputs (not expandable)
Program memory	4000 steps EEPROM (internal), exchangeable EEPROM memory cassette
Cycle period	0.21 μs /logical instruction
Number of instructions	27 sequence instructions, 2 step ladder instructions, 116 applied instructions
Programming language	Step ladder, instruction list, SFC
Program execution	Cyclical execution, refresh mode processing
Program protection	Via password

System specifications	FX3S
<b>Operands</b>	
Internal relays	1,536
Special relays	512
Step ladder	256
Timer	138
Ext. preset value via potentiometer	2
Counter	67
High-speed counter	6 single phase inputs (max. 60 kHz), 3 double phase inputs (max. 30 kHz)
Real-time clock	Year, month, day, hour, minute, second, weekday
Data register	3,000
File register	2,000
Index register	16
Special register	512 (D8000–D8511)
Pointer	2,048
Nestings	8
Interrupt inputs	6
Constants	16 bits: K: -32768–+32767, hex: 0–FFFF 32 bits: K: 2147483648–+2147483647, hex: 0–FFFF FFFF

## The MELSEC FX3G series

**Integrated high-speed counter inputs** for processing fast input signals. For example, you can configure two 60 kHz counters and four 10 kHz counters. **Interrupt processing** is also handled via the inputs.

RAM/EEPROM memory for up to **32,000 PLC program steps** gives you plenty of reserve, even for big, complex applications.

The base units can be expanded to provide configurations with up to 256 inputs and outputs with modular and **compact extension units** (128 directly and 256 in common by using remote I/Os via a network).

**Integrated real-time clock** with year, month, day and time

Two **integrated pulse outputs** for frequencies from 2 to 100,000 Hz for controlling stepping motors and outputting **pulse-width modulated signals**.

An **integrated RUN/STOP switch** is available.

Connection possibility for special function adapter modules

Two **integrated serial interfaces** for direct communication with computers.

Add-in function boards can be installed in the PLC to provide a **second RS485/RS422/RS232 communications interface** for programming or network configurations. Analog function boards for input and output and a function board with 8 analog potentiometers are also available as add-in.

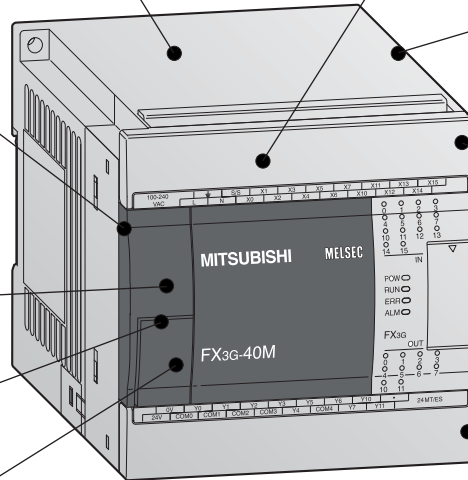

2

FX Base Units

## Description of the unit components

- Terminal cover
- Terminal protector
- Input terminals
- Input indicator LEDs
- Operation status indicator LEDs
- Expansion bus connector cover
- Output indicator LEDs
- Output terminals
- Terminal protector
- Terminal cover

Cover of the right extension slot and the optional battery

Cover for the left extension slot

Memory cassette, display module, and expansion board connector

2 analog potentiometers

RUN/STOP switch

Option battery holder

Programming port: RS422

Programming port: USB

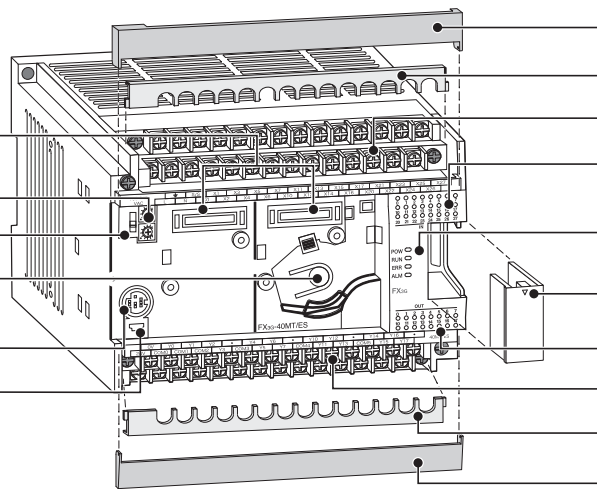

Flip cover for programming port, potentiometer and Run/Stop switch

Cover for the left extension slot

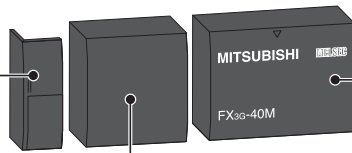

## Base units

FX3S  FX3G  FX3GC  FX3GE  FX3U  FX3UC

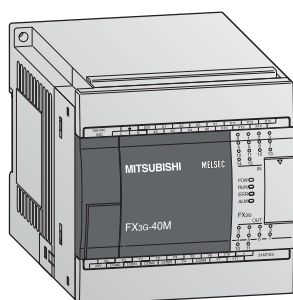

### Base units FX3G

The FX3G series base units are available with 14 to 60 input/output points.

It is possible to choose between relay and transistor output types.

- Integrated USB interface for communication between PLCs and PC
- Integrated serial interface for communication between PCs and HMI
- LEDs for indicating the input and output status
- Detachable terminal blocks for all units

- Slot for memory cassettes
- Integrated real-time clock
- Integrated positioning control
- Exchangeable interface and extension adapters for direct mounting into a base unit
- Expandable with digital I/O modules, special function modules and ADP modules
- User-friendly programming systems, including IEC 61131-3 (EN 61131-3) compatible programming software, HMIs and hand-held programming units

## Base units with 14–24 I/Os

Specifications	FX3G-14 MR/ES	FX3G-14 MT/ESS	FX3G-14 MR/DS	FX3G-14 MT/DSS	FX3G-24 MR/ES	FX3G-24 MT/ESS	FX3G-24 MR/DS	FX3G-24 MT/DSS
Max. number inputs/outputs	14	14	14	14	24	24	24	24
Power supply	100–240 V AC	100–240 V AC	24 V DC	24 V DC	100–240 V AC	100–240 V AC	24 V DC	24 V DC
Integrated inputs	8	8	8	8	14	14	14	14
Integrated outputs	6	6	6	6	10	10	10	10
Output type	Relay	Transistor (source)*	Relay	Transistor (source)*	Relay	Transistor (source)*	Relay	Transistor (source)*
Power consumption	W 31	31	19	19	32	32	21	21
Weight	kg 0.50	0.50	0.50	0.50	0.55	0.55	0.55	0.55
Dimensions (WxHxD)	mm 90x90x86	90x90x86	90x90x86	90x90x86	90x90x86	90x90x86	90x90x86	90x90x86
Order information	Art. no. 231466	231470	231474	231478	231467	231471	231475	231479

## Base units with 40–60 I/Os

Specifications	FX3G-40 MR/ES	FX3G-40 MT/ESS	FX3G-40 MR/DS	FX3G-40 MT/DSS	FX3G-60 MR/ES	FX3G-60 MT/ESS	FX3G-60 MR/DS	FX3G-60 MT/DSS
Max. number inputs/outputs	40	40	40	40	60	60	60	60
Power supply	100–240 V AC	100–240 V AC	24 V DC	24 V DC	100–240 V AC	100–240 V AC	24 V DC	24 V DC
Integrated inputs	24	24	24	24	36	36	36	36
Integrated outputs	16	16	16	16	24	24	24	24
Output type	Relay	Transistor (source)*	Relay	Transistor (source)*	Relay	Transistor (source)*	Relay	Transistor (source)*
Power consumption	W 37	37	25	25	40	40	29	29
Weight	kg 0.70	0.70	0.70	0.70	0.85	0.85	0.85	0.85
Dimensions (WxHxD)	mm 130x90x86	130x90x86	130x90x86	130x90x86	175x90x86	175x90x86	175x90x86	175x90x86
Order information	Art. no. 231468	231472	231476	231480	231469	231473	231477	231481

\* Sink type transistor output units on request.

## The MELSEC FX3GE series

**Integrated high-speed counter inputs** for processing fast input signals. For example, you can configure two 60 kHz counters and four 10 kHz counters. **Interrupt processing** is also handled via the inputs.

RAM/EEPROM memory for up to **32,000 PLC program steps** gives you plenty of reserve, even for big, complex applications.

The base units can be expanded to provide configurations with up to 256 inputs and outputs with modular and **compact extension units** (128 directly and 256 in common by using remote I/Os via a network).

Add-in function boards can be installed in the PLC to provide a **second RS485/RS422/RS232 communications interface** for programming or network configurations. Analog function boards for input and output and a function board with 8 analog potentiometers are also available as add-in.

**Integrated real-time clock** with year, month, day and time

Connection possibility for special function adapter modules

An **integrated RUN/STOP switch** is available.

**Two integrated serial interfaces** for direct communication with computers.

**Two integrated pulse outputs** for frequencies from 2 to 100,000 Hz for controlling stepping motors and outputting **pulse-width modulated signals**.

## Description of the unit components

Memory cassette, display module, and extension board connector

Terminals for analog inputs

2 analog potentiometers

RUN/STOP switch

Connection for adapter modules

RS-422 interface

USB interface

RJ45 socket (10BASE-T/100BASE-TX)

Terminals for analog output

Terminal cover

Terminal protector

Terminals for digital inputs

LEDs for input status

Battery bracket

Operation status indicator LEDs

Cover for the extension slot

LEDs for output status

Terminals for digital outputs

Terminal protector

Terminal cover

Cover for interface, potentiometer and RUN/STOP switch

Cover for the extension slot and the optional battery

## Base units

FX3S  FX3G  FX3GC  FX3GE  FX3U  FX3UC

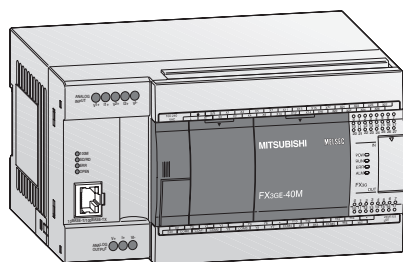

### Base units FX3GE

The FX3GE series base units are available with 24 or 40 input/output points.

All base units are equipped with relay outputs.

- Integrated analog input (2ch)
- Integrated analog output (1ch)
- Integrated Ethernet interface
- Integrated USB interface for communication between PLC and PC
- Integrated serial interface for communication between PLC and HMI
- LEDs for indicating the input and output status
- Connection of inputs and outputs via terminals
- Slot for memory cassettes
- Integrated positioning control
- Expandable with special function modules and ADP modules
- User-friendly programming systems, including IEC 61131-3 (EN 61131-3) compatible programming software, HMIs and hand-held programming units

## Base units with 24 I/Os

Specifications	FX3GE-24 MR/ES	FX3GE-24 MT/ESS	FX3GE-24 MR/DS	FX3GE-24 MT/DSS
Max. number inputs/outputs	24	24	24	24
Power supply	100–240 V AC	100–240 V AC	24 V DC	24 V DC
Integrated inputs	14	14	14	14
Integrated outputs	10	10	10	10
Output type	Relay	Transistor (source)*	Relay	Transistor (source)*
Power consumption	W 32	32	21	21
Weight	kg 0.6	0.55	0.55	0.55
Dimensions (WxHxD)	mm 130x90x86	90x90x86	90x90x86	90x90x86
<b>Order information</b>	Art. no. 264869	269884	269917	269919

## Base units with 40 I/Os

Specifications	FX3GE-40 MR/ES	FX3GE-40 MT/ESS	FX3GE-40 MR/DS	FX3GE-40 MT/DSS
Max. number inputs/outputs	40	40	40	40
Power supply	100–240 V AC	100–240 V AC	24 V DC	24 V DC
Integrated inputs	24	24	24	24
Integrated outputs	16	16	16	16
Output type	Relay	Transistor (source)*	Relay	Transistor (source)*
Power consumption	W 37	37	25	25
Weight	kg 0.8	0.70	0.70	0.70
Dimensions (WxHxD)	mm 175x90x86	130x90x86	130x90x86	130x90x86
<b>Order information</b>	Art. no. 264870	269916	269920	269922

\* Sink type transistor output units on request.

## The MELSEC FX3GC series

2

FX Base Units

**Integrated high-speed counter inputs** for processing fast input signals. For example, you can configure two 60 kHz counters and four 10 kHz counters. **Interrupt processing** is also handled via the inputs.

RAM/EEPROM memory for up to **32,000 PLC program steps** gives you plenty of reserve, even for big, complex applications.

The base units can be expanded to provide configurations with up to 256 inputs and outputs with modular and **compact extension units** (128 directly and 256 in common by using remote I/Os via a network).

An **integrated RUN/STOP switch** is available.

**Integrated real-time clock** with year, month, day and time

**Two integrated serial interfaces** for direct communication with computers.

Two **integrated pulse outputs** for frequencies from 2 to 100,000 Hz for controlling stepping motors and outputting **pulse-width modulated signals**.

Connection possibility for special function adapter modules

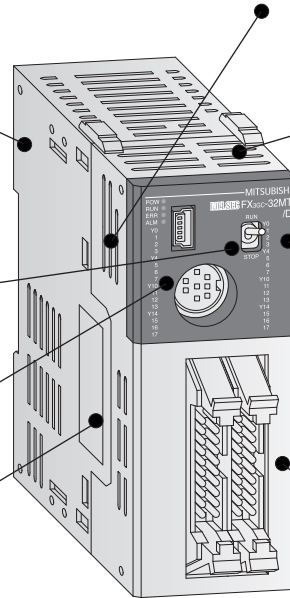

## Description of the unit components

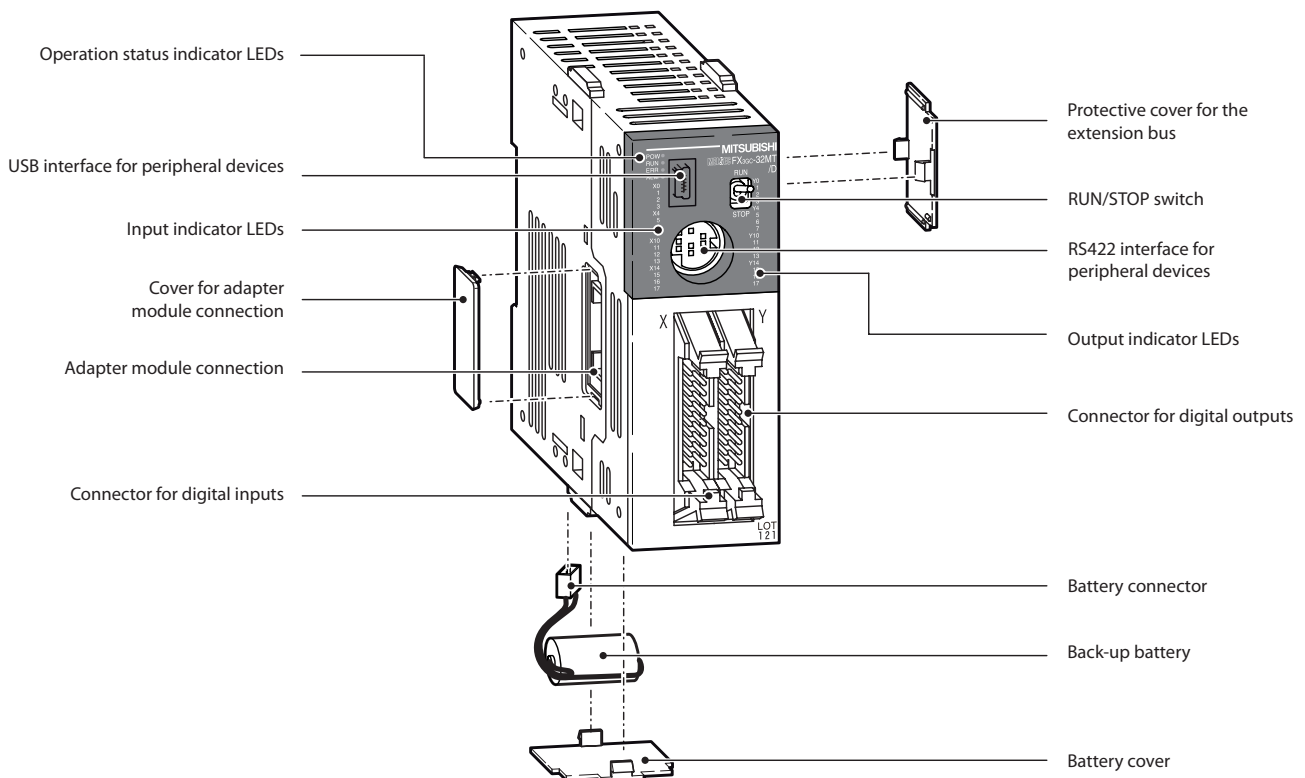

## ■ Base unit

FX3S  FX3G  FX3GC  FX3GE  FX3U  FX3UC

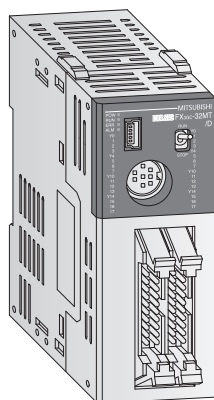

### Base unit FX3GC

The base unit FX3GC-32 MT/DSS (FX3GC series) is available with 32 input/output points.

The base unit is equipped with transistor outputs.

- Integrated USB interface for communication between PLC and PC
- Integrated serial interface for communication between PLC and HMI
- LEDs for indicating the input and output status
- Connection of inputs and outputs via connectors.

- Integrated positioning control
- Expandable with digital I/O modules, special function modules and ADP modules
- User-friendly programming systems, including IEC 61131-3 (EN 61131-3) compatible programming software, HMIs and hand-held programming units

## Base unit with 32 I/Os

Specifications	FX3GC-32 MT/DSS
Max. number inputs/outputs	32
Power supply	24 V DC
Integrated inputs	16
Integrated outputs	16
Output type	Transistor (source)
Power consumption	W 8
Weight	kg 0.2
Dimensions (WxHxD)	mm 34x90x87
<b>Order information</b>	Art. no. 251546

**Specifications**

FX3S  FX3G  FX3GC  FX3GE  FX3U  FX3UC

**Environmental specifications**

General specifications	FX3G	FX3GE	FX3GC
Ambient temperature	0–55 °C (storage temperature: -25–+75 °C)		
Noise durability	1000 Vpp with noise generator; 1 μs at 30–100 Hz		
Dielectric withstand voltage	1500 V AC, 1 min		500 V AC, 1 min
Ambient relative humidity	5–95 % (non-condensing)		
Shock resistance	Acc. to IEC 68-2-27: 15 g (147 m/s <sup>2</sup> ) (3 times each in 3 directions for 11 ms)		
Vibration resistance	Acc. to IEC 68-2-6: 1 g (resistance to vibrations from 57–150 Hz for 80 minutes along all 3 axes); 0.5 g for DIN rail mounting		
Insulation resistance	5 MΩ, 500 V DC		
Ground	Class D: Grounding resistance 100 Ω or less		
Fuse rating	For FX3G-14M□ and FX3G-24M□: 250 V 1 A; For FX3G-40M□ and FX3G-60M□: 250 V 3.15 A	FX3GE-24M□: 250 V 1 A; FX3GE-40M□: 250 V 3.15 A	125 V 3, 15 A
Environment	Avoid environments containing corrosive gases, install in a dust-free location.		
Certifications	Please refer to pages 66–67		

**Electrical specifications**

Power supply specifications	FX3G	FX3GE	FX3GC
Power supply	AC	100–240 V (+10 % / -15 %), 50/60 Hz	
	DC	24 V DC (+20 % / -15 %)	
Inrush current at ON	AC	30 A / <5 ms (at 100 V AC); 50 A / <5 ms (at 200 V AC)	
	DC	30 A / <1 ms (at 24 V DC)	30 A / <0.5 ms (at 24 V DC)
Allowable momentary power failure time	10 ms	10 ms	5 ms
External power supply (24 V DC)	400 mA	400 mA	—

Output specifications	Relay modules FX3G/FX3GE	Transistor modules FX3G/FX3GE	Transistor modules FX3GC
Switching voltage (max.)	V <240 V AC, <30 V DC	5–30 V DC	5–30 V DC
Max. output current	- per output	A 2	0,5
	- per group	A 8 <sup>Ⓢ</sup>	0,8 <sup>Ⓢ</sup>
Max. switching current	- inductive load	W 80 VA	12 W
			Y000, Y001: 7.2 Y002–Y017: 2.4
Response time	ms 10	<0.2 (<5 μs for Y0, Y1) <sup>Ⓢ</sup>	<0.2 (<5 μs for Y0, Y1)

<sup>Ⓢ</sup> The 40 and 60 I/O points main units supports 5 μs for Y2.

<sup>Ⓢ</sup> This limitation applies only per reference terminal for each group, 4 and 8 outputs for relays and 2 and 4 outputs for transistors. Please observe the terminal assignments for the group identification.

**Programming specifications**

System specifications	FX3G	FX3GE	FX3GC
<b>Program data</b>			
I/O points (addresses)	256 total (combined local and CC-Link remote I/O)		
Address range	Max. 128 direct addressing and max. 128 remote I/O		
Program memory	32,000 steps EEPROM (internal), exchangeable EEPROM memory cassette		
Cycle period	0.21 μs or 0.42 μs/contact instruction		
Number of instructions	29 sequence instructions, 2 step ladder instructions, 123 applied instructions		29 sequence instructions, 2 step ladder instructions, 122 applied instructions
Programming language	Step ladder, instruction list, SFC		
Program execution	Cyclical execution, refresh mode processing		
Program protection	Via password		

System specifications	FX3G	FX3GE	FX3GC
<b>Operands</b>			
Internal relays	7,680		
Special relays	512		
Step ladder	4,096		
Timer	320		
Ext. preset value via potentiometer	2		
Counter	235		
High-speed counter	6 single phase inputs (max. 60 kHz), 3 double phase inputs (max. 30 kHz)		
Real-time clock	Year, month, day, hour, minute, second, weekday		
Data register	8,000		
File register	24,000 (R0–R23999) internal/optional memory		24,000 (R0–R23999)
Extension file register	24,000 (ER0–ER23999)		
Index register	16		
Special register	512 (D8000–D8511)		
Pointer	2,048		
Nestings	8		
Interrupt inputs	6		
Constants	16 bits: K: -32768–+32767, hex: 0–FFFF		
	32 bits: K: 2147483648–+2147483647, hex: 0–FFFF FFFF		



## The MELSEC FX3U series

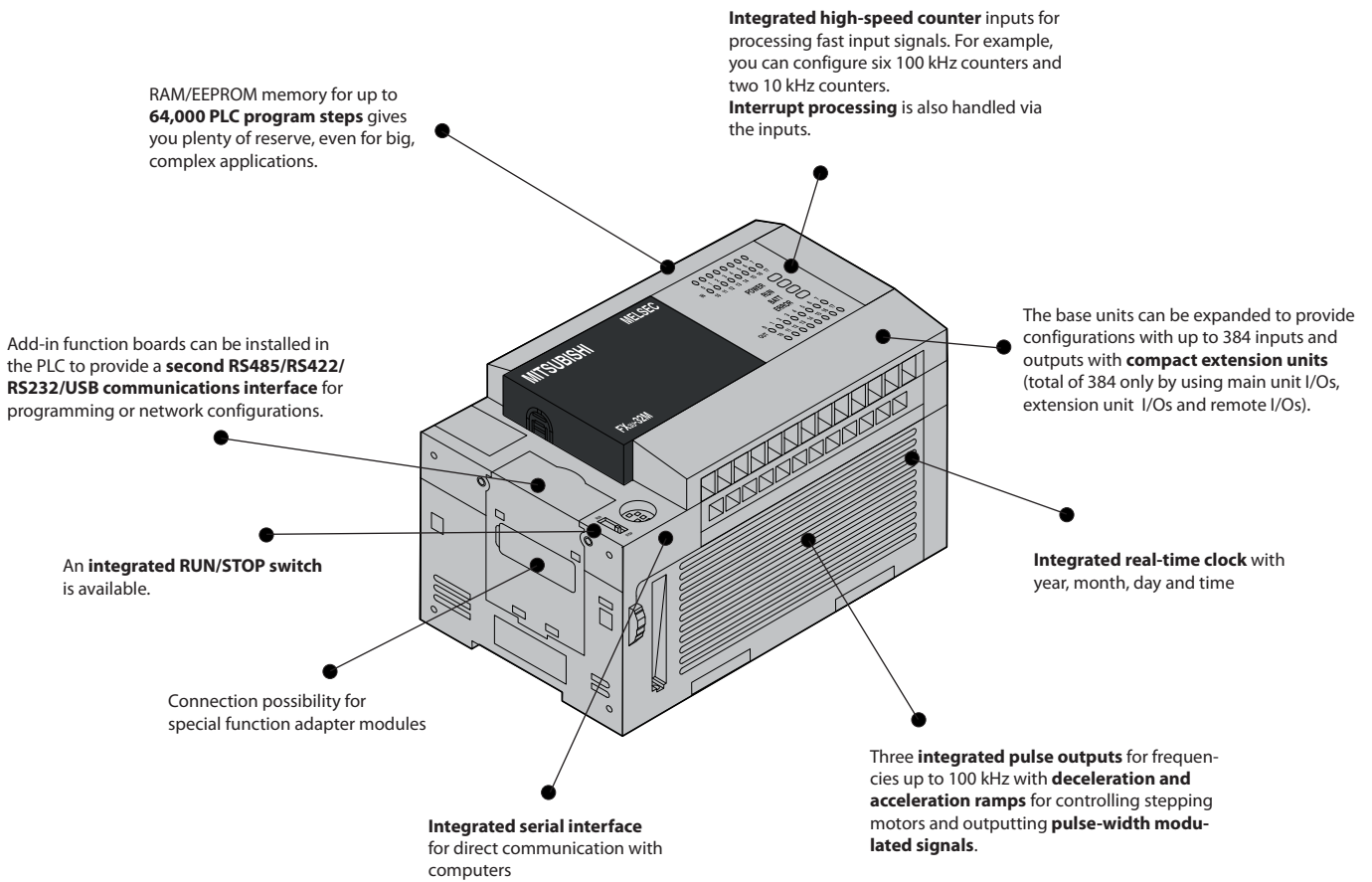

## Description of the unit components

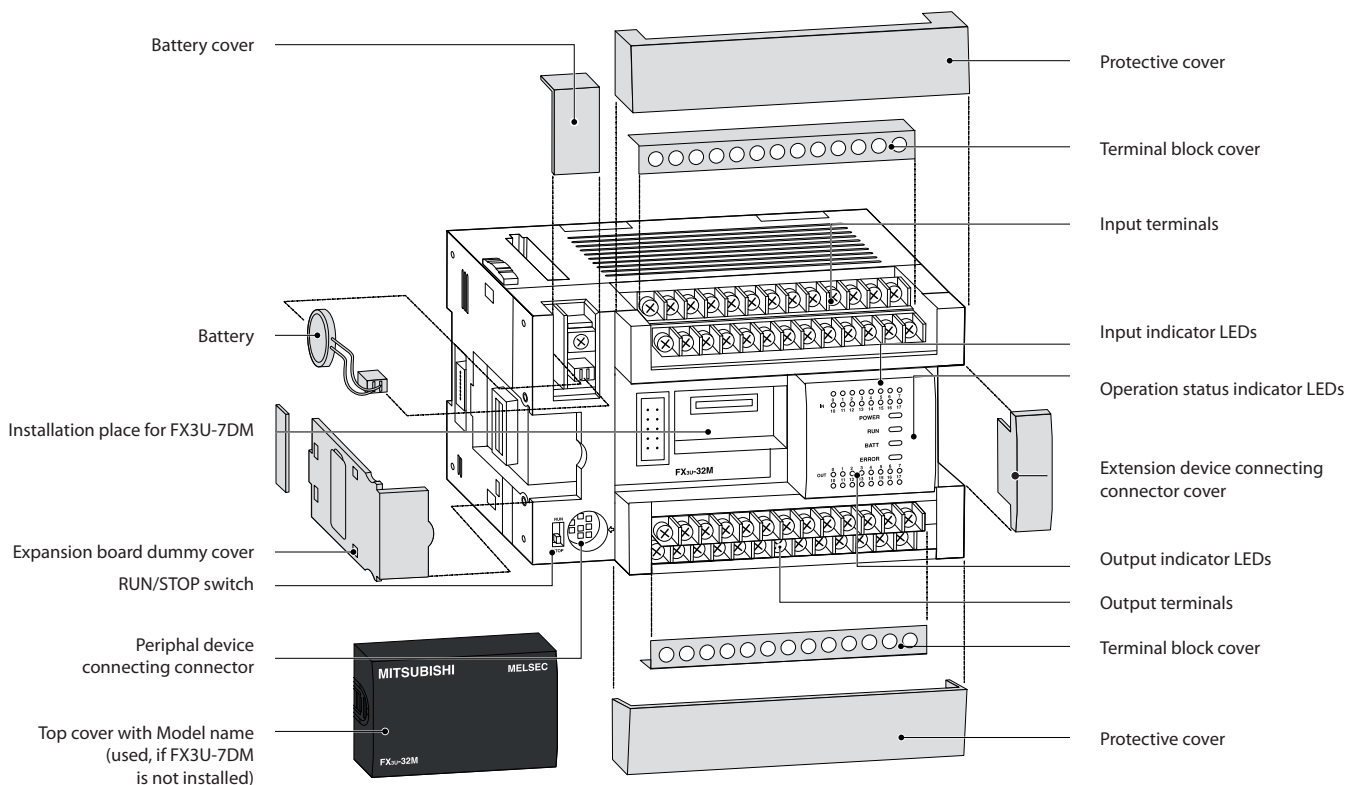

■ Base units 
 FX3S  FX3G  FX3GC  FX3GE  FX3U  FX3UC

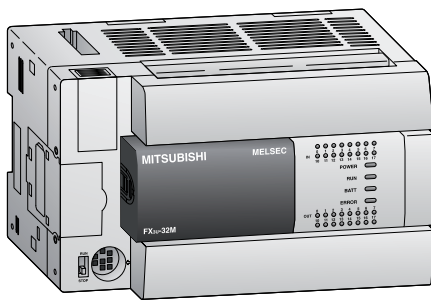

**Base units FX3U**

The FX3U series base units are available with 16, 32, 48, 64, 80 or 128 input/output points expandable to 384 points.

Models are available for selection with relay or transistor outputs.

- Integrated serial interface for communication between PCs and HMI
- Integrated positioning control
- Exchangeable interface modules for direct mounting into a base unit

- LEDs for indicating the input and output status
- Slot for memory cassettes
- Integrated real-time clock
- Expandable with digital I/O modules, special function modules and ADP modules
- User-friendly programming systems, including IEC 61131-3 (EN 61131-3) compatible programming software, HMIs and hand-held programming units

**Base units with 16 I/Os**

Specifications	FX3U-16 MR/DS	FX3U-16 MR/ES	FX3U-16 MT/DSS	FX3U-16 MT/ESS
Max. number inputs/outputs	16	16	16	16
Power supply	24 V DC	100–240 V AC	24 V DC	100–240 V AC
Integrated inputs	8	8	8	8
Integrated outputs	8	8	8	8
Output type	Relay	Relay	Transistor (source)	Transistor (source)
Power consumption	25 W	30 VA	25 W	30 VA
Weight	kg 0.6	0.6	0.6	0.6
Dimensions (WxHxD)	mm 130x90x86	130x90x86	130x90x86	130x90x86
<b>Order information</b>	Art. no. 231498	231486	231503	231492

**Base units with 32 I/Os**

Specifications	FX3U-32 MR/DS	FX3U-32 MR/ES	FX3U-32 MT/DSS	FX3U-32 MT/ESS
Max. number inputs/outputs	32	32	32	32
Power supply	24 V DC	100–240 V AC	24 V DC	100–240 V AC
Integrated inputs	16	16	16	16
Integrated outputs	16	16	16	16
Output type	Relay	Relay	Transistor (source)	Transistor (source)
Power consumption	30 W	35 VA	30 W	35 VA
Weight	kg 0.65	0.65	0.65	0.65
Dimensions (WxHxD)	mm 150x90x86	150x90x86	150x90x86	150x90x86
<b>Order information</b>	Art. no. 231499	231487	231504	231493

Note: Further special versions are available on request

## Base units with 48 I/Os

Specifications	FX3U-48 MR/DS	FX3U-48 MR/ES	FX3U-48 MT/ESS	FX3U-48 MT/DSS
Max. number inputs/outputs	48	48	48	48
Power supply	24 V DC	100–240 V AC	100–240 V AC	24 V DC
Integrated inputs	24	24	24	24
Integrated outputs	24	24	24	24
Output type	Relay	Relay	Transistor (source)	Transistor (source)
Power consumption	35 W	40 VA	40 VA	35 W
Weight	kg 0.85	0.85	0.85	0.85
Dimensions (WxHxD)	mm 182x90x86	182x90x86	182x90x86	182x90x86
<b>Order information</b>	Art. no. 231500	231488	231494	231505

## Base units with 64 I/Os

Specifications	FX3U-64 MR/DS	FX3U-64 MR/ES	FX3U-64 MT/ESS	FX3U-64 MT/DSS
Max. number inputs/outputs	64	64	64	64
Power supply	24 V DC	100–240 V AC	100–240 V AC	24 V DC
Integrated inputs	32	32	32	32
Integrated outputs	32	32	32	32
Output type	Relay	Relay	Transistor (source)	Transistor (source)
Power consumption	40 W	45 VA	45 VA	40 W
Weight	kg 1.0	1.0	1.0	1.0
Dimensions (WxHxD)	mm 220x90x86	220x90x86	220x90x86	220x90x86
<b>Order information</b>	Art. no. 231501	231489	231495	231506

## Base units with 80–128 I/Os

Specifications	FX3U-80 MR/DS	FX3U-80 MR/ES	FX3U-80 MT/DSS	FX3U-80 MT/ESS	FX3U-128 MR/ES	FX3U-128 MT/ESS
Max. number inputs/outputs	80	80	80	80	128	128
Power supply	24 V DC	100–240 V AC	24 V DC	100–240 V AC	100–240 V AC	100–240 V AC
Integrated inputs	40	40	40	40	64	64
Integrated outputs	40	40	40	40	64	64
Output type	Relay	Relay	Transistor (source)	Transistor (source)	Relay	Transistor (source)
Power consumption	45 W	50 VA	45 W	50 VA	65 VA	65 VA
Weight	kg 1.2	1.2	1.2	1.2	1.8	1.8
Dimensions (WxHxD)	mm 285x90x86	285x90x86	285x90x86	285x90x86	350x90x86	350x90x86
<b>Order information</b>	Art. no. 231502	231490	231507	231496	231491	231497

## Specifications

 FX3S  FX3G  FX3GC  FX3GE  FX3U  FX3UC

### Environmental specifications

General specifications	Data
Ambient temperature	0–55 °C (storage temperature: -25–+75 °C)
Protection	IP10
Noise durability	1000 Vpp with noise generator; 1 µs at 30–100 Hz
Dielectric withstand voltage	AC PSU: 1500 V AC, 1 min./DC PSU: 500 V AC, 1 min.
Ambient relative humidity	5–95 % (non-condensing)
Shock resistance	Acc. to IEC 68-2-27: 15 g (3 times each in 3 directions for 11 ms)
Vibration resistance	Acc. to IEC 68-2-6: 1 g (resistance to vibrations from 57–150 Hz for 80 minutes along all 3 axes); 0.5 g for DIN rail mounting
Insulation resistance	5 MΩ, 500 V DC
Ground	Class D: Grounding resistance 100 Ω or less
Fuse rating	From FX3U-16M□ to FX3U-32M□: 3.15 A; from FX3U-48M□ to FX3U-128M□: 5 A
Environment	Avoid environments containing corrosive gases, install in a dust-free location.
Certifications	Please refer to pages 66–67

### Electrical specifications

Power supply specifications	DC powered modules (FX3U-□M□/DS/DSS)	AC powered modules (FX3U-□MR/ES)
Power supply	24 V DC (+20 %/-30 %)	100–240 V AC (+10 %/-15 %), 50/60 Hz
Inrush current at ON	—	30 A/<5 ms (at 100 V AC); 65 A/<5 ms (at 200 V AC)
Allowable momentary power failure time	5 ms	10 ms
Primary power supply	24 V DC	—
External power supply (24 V DC)	—	FX3U-16/32MR/ES: 400 mA/ FX3U-48–128MR/ES: 600 mA

Output specifications	Relay-modules	Transistor-modules
Switching voltage (max.)	V <240 V AC, <30 V DC	5–30 V DC
Max. output current	- per output A 2 - per group* A 8	0.5/0.3 <sup>①</sup> 0.8/1.6 <sup>②</sup>
Max. switching current	- inductive load 80 VA	12 W/7.2 W
Response time	ms 10	<0.2 (Y0,Y1 <30 µs)
Life of contacts (switching times) <sup>③</sup>	3,000,000 at 20 VA; 1,000,000 at 35 VA; 200,000 at 80 VA	

<sup>①</sup> or Y0 and Y1 = 0.3 A; all others 0.5 A    <sup>②</sup> 0.8 for 4 per group and 1.6 for 8 per group

<sup>③</sup> Not guaranteed by Mitsubishi Electric.

\* This limitation applies only per reference terminal for each group, 4 and 8 outputs for relays and 2 and 4 outputs for transistors. Please observe the terminal assignments for the group identification.

### Programming specifications

System specifications	FX3U
<b>Program data</b>	
I/O points (addresses)	Max. total 384 (with remote I/O)
Address range	Max. 256 direct addressing and max. 256 network I/Os
Program memory	64,000 steps RAM (internal), exchangeable FLROM for easy program exchange
Cycle period	0.065 µs/basic instruction
Number of instructions	27 sequence instructions, 2 step ladder instructions, 209 applied instructions
Programming language	Step ladder, instruction list, SFC
Program execution	Cyclical execution, refresh mode processing
Program protection	Password protection with 3 protection levels*

\* Protection levels may only be changed with FX-10P/FX-20P/FX-30P.

System specifications	FX3U
<b>Operands</b>	
Internal relays	7,680
Special relays	512
Step ladder	4,096
Timer	512
Counter	235
High-speed counter	16
High-speed counter speed	1 phase, 8 points max: 100 kHz/6 points 10 kHz/2 points 2 phase, 2 points max: 50 kHz/2 points
Real-time clock	Year, month, day, hour, minute, second, weekday
Data register	8,000
Extension file register	32,768
Index register	16
Special register	512
Pointer	4,096
Nestings	8
Interrupt inputs	6
Constants	16 bits: K: -32768–+32767, hex: 0–FFFF 32 bits: K: 2147483648–+2147483647, hex: 0–FFFF FFFF

### The MELSEC FX3UC series

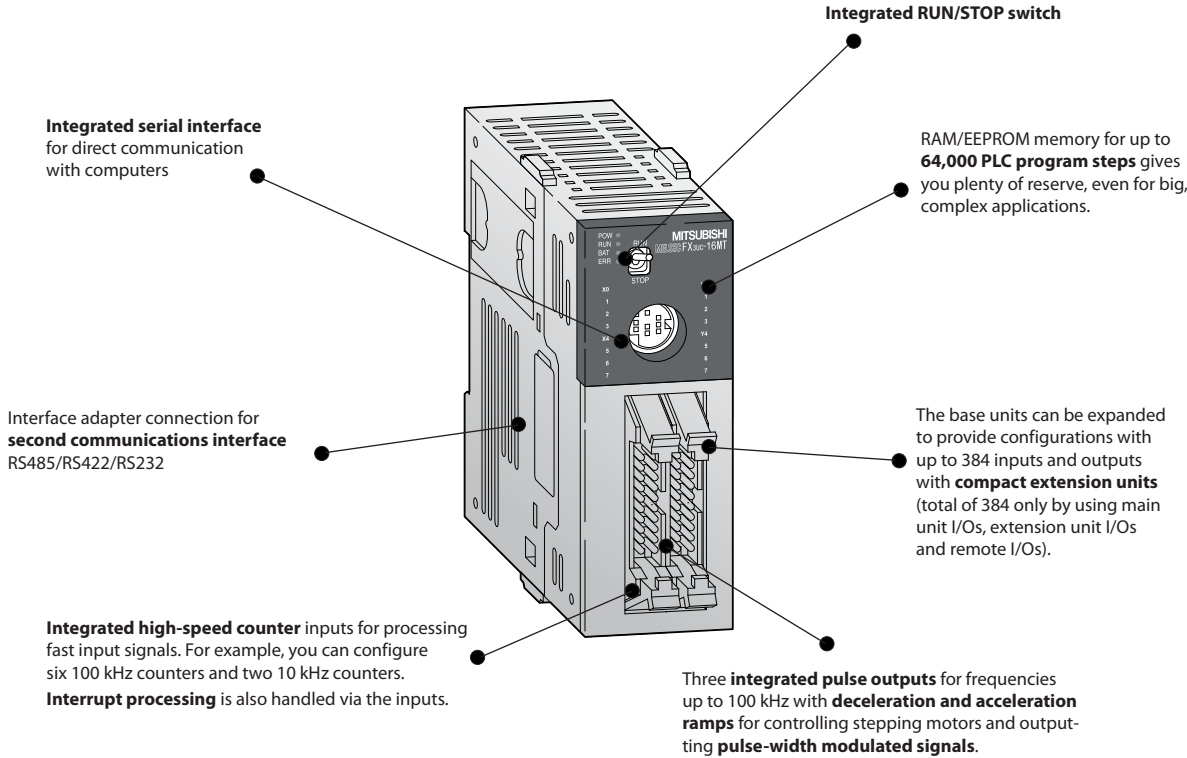

### Description of the unit components

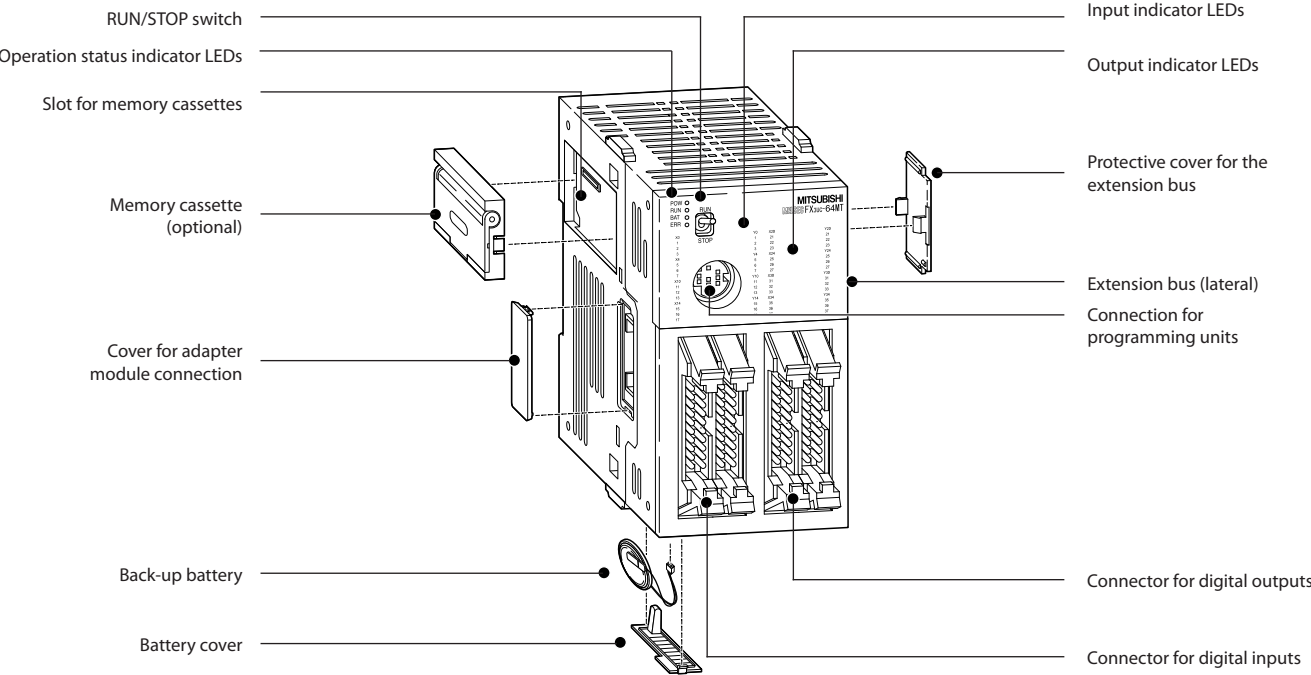

■ Base units 
 FX3S  FX3G  FX3GC  FX3GE  FX3U  FX3UC

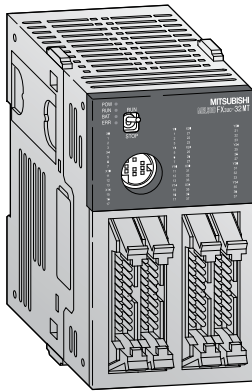

**Base units FX3UC**

The base units of the FX3UC series are available in versions with 16, 32, 64 or 96 inputs/outputs (expandable to 384 I/Os).

The units are available with transistor outputs only.

- Integrated serial interface for communication between PCs and HMI
- Same instruction set as FX3U
- Integrated positioning control
- Very compact dimensions

- LEDs for indicating the input and output status
- Slot for memory cassette
- Adapter modules and system cabling sets available for units with ribbon cable connectors
- Expandable with digital I/O modules, special function modules and ADP modules
- User-friendly programming systems, including IEC 61131-3 (EN 61131-3) compatible programming software, HMIs and hand-held programming units

**Base units with 16–96 I/Os**

Specifications	FX3UC-16 MT/DSS	FX3UC-32 MT/DSS	FX3UC-64 MT/DSS	FX3UC-96 MT/DSS
Max. number inputs/outputs	16	32	64	96
Power supply	24 V DC (+20 %, -15 %)	24 V DC (+20 %, -15 %)	24 V DC (+20 %, -15 %)	24 V DC (+20 %, -15 %)
Integrated inputs	8	16	32	48
Integrated outputs	8	16	32	48
Output type	Transistor (source)*	Transistor (source)*	Transistor (source)*	Transistor (source)*
Power consumption	W 6	8	11	14
Weight	kg 0.2	0.2	0.3	0.35
Abmessungen (B x H x T)	mm 34x90x74	34x90x74	59.7x90x74	85.4x90x74
<b>Order information</b>	Art. no. 231508	231509	231510	231511

\* Units with sink type transistor outputs on request.

**System cabling**

A choice of terminal blocks with screw or spring terminals are available for easy wiring of the FX3UC modules with standard ribbon cable connectors.

For detailed information about the terminal blocks, please refer to the FX Family catalogue.

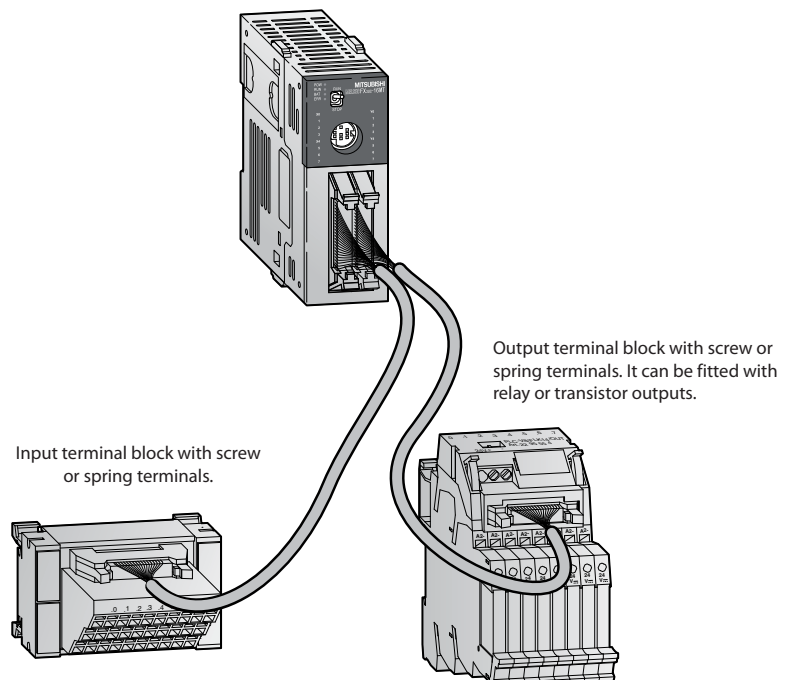

## Specifications

 FX3S  FX3G  FX3GC  FX3GE  FX3U  FX3UC

### Environmental specifications

General specifications	Data
Ambient temperature	0–55 °C (storage temperature: -25–+75 °C)
Protection	IP10
Noise durability	1000 Vpp with noise generator; 1 µs bei 30–100 Hz
Dielectric withstand voltage	AC PSU: 1500 V AC, 1 min./DC PSU: 500 V AC, 1 min.
Ambient relative humidity	5–95 % (non-condensing)
Shock resistance	Acc. to IEC 68-2-27: 15 g (3 times each in 3 directions for 11 ms)
Vibration resistance	Acc. to IEC 68-2-6: 1 g (resistance to vibrations from 57–150 Hz for 80 minutes along all 3 axes); 0.5 g for DIN rail mounting
Insulation resistance	500 V DC, 5 MΩ
Ground	Class D: Grounding resistance 100 Ω or less
Environment	Avoid environments containing corrosive gases, install in a dust-free location.
Certifications	Please refer to pages 66–67

### Electrical specifications

Power supply specifications	Alle modules
Power supply	24 V DC (+20 %/-30 %)
Inrush current at ON	—
Allowable momentary power failure time	5 ms
Primary power supply	24 V DC
External power supply (24 V DC)	—

Output specifications	Alle modules
Switching voltage (max.)	V 5–30 V DC
Max. output current	- per output A 0.1/0.3 <sup>①</sup>
	- per group* A 0.8/1.6
Max. switching current	- inductive load 2.4 W/7.2 W <sup>②</sup>
Response time	ms <0.2 (Y0, Y1 <30 µs)
Life of contacts (switching times) <sup>③</sup>	3,000,000 at 20 VA; 1,000,000 at 35 VA; 200,000 at 80 VA

<sup>①</sup> or Y0 and Y1 = 0.3 A; all others 0.1 A    <sup>②</sup> 7.2 W for Y0 to Y3, all other outputs 2.4 W

<sup>③</sup> Not guaranteed by Mitsubishi Electric.

\* This limitation applies only per reference terminal for each group, 4 and 8 outputs for relays and 2 and 4 outputs for transistors. Please observe the terminal assignments for the group identification.

### Programming specifications

System specifications	FX3UC
<b>Program data</b>	
I/O points (addresses)	Max. total 384 (with remote I/O)
Address range	Max. 256 direct addressing and max. 256 network I/Os
Program memory	64,000 steps RAM (internal), exchangeable FLROM for easy program exchange
Cycle period	0.065 µs/basic instruction
Number of instructions	27 sequence instructions, 2 step ladder instructions, 209 applied instructions
Programming language	Step ladder, instruction list, SFC
Program execution	Cyclical execution, refresh mode processing
Program protection	Password protection with 3 protection levels*

\* Protection levels may only be changed with FX-30P.

System specifications	FX3UC
<b>Operands</b>	
Internal relays	7,680
Special relays	512
Step ladder	4,096
Timer	512
Counter	235
High-speed counter	16
High-speed counter speed	1 phase, 8 points max: 100 kHz/6 points 10 kHz/2 points 2 phase, 2 points max: 50 kHz/2 points
Real-time clock	Year, month, day, hour, minute, second, weekday
Data register	8,000
Extension file register	32,768
Index register	16
Special register	512
Pointer	4,096
Nestings	8
Interrupt inputs	6
Constants	16 bits: K: -32768–+32767, hex: 0–FFFF 32 bits: 2K: 147483648–+2147483647, hex: 0–FFFF FFFF

■ Powered compact extension units

FX3S  FX3G  FX3GC  FX3GE  FX3U  FX3UC

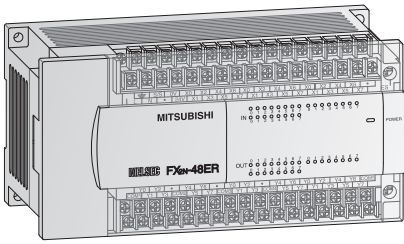

**Extension units FX2N**

The FX2N series extension units are available with 32 or 48 input/output points.

It is possible to choose between relay and transistor output type.

- LEDs for indicating the input and output status
- MELSEC FX3G/FX3GE and FX3U series compatible
- Detachable terminal blocks
- Integrated service power supply with 250 mA or 460 mA

Specifications	FX2N-32 ER-ES/UL	FX2N-32 ET-ESS/UL	FX2N-48 ER-DS	FX2N-48 ER-ES/UL	FX2N-48 ET-DSS	FX2N-48 ET-ESS/UL	
<b>Electrical data</b>							
Integrated inputs/outputs	32	32	48	48	48	48	
Power supply	AC range (+10%, -15%)	100–240 V	—	100–240 V	—	100–240 V	
	frequency at AC	50/60 Hz	—	50/60	—	50/60	
	DC range (+20%, -30%)	—	—	24 V	—	24 V	
Max. input apparent power	—	35 VA	30 W	45 VA	30 W	45 VA	
Inrush current at ON	100 V AC	40 A<5 ms	—	40 A<5 ms	40 A<5 ms	40 A<5 ms	
	200 V AC	60 A<5 ms	—	60 A<5 ms	60 A<5 ms	60 A<5 ms	
Allowable momentary power failure time	ms	10	5	10	5	10	
External service power supply (24 V DC)	mA	250	—	460	—	460	
Power supply int. bus (5 V DC)	mA	690	690	690	690	690	
<b>Inputs</b>							
Integrated inputs	16	16	24	24	24	24	
Min. current for logical 1	mA	3.5	3.5	3.5	3.5	3.5	
Max. current for logical 0	mA	1.5	1.5	1.5	1.5	1.5	
Response time	For all extension units of the MELSEC FX2N series: 10 ms (at time of shipment)						
<b>Outputs</b>							
Integrated outputs	16	16	24	24	24	24	
Output type	Relay	Transistor (source)	Relay	Relay	Transistor (source)	Transistor (source)	
Switching voltage (max.)	Generally for relay version: <264 V AC, <30 V DC; for transistor version: 5–30 V DC						
Max. output current	- per output	A	2	2	0.5	0.5	
	- per group*	A	8	8	0.8/1.6 <sup>②</sup>	0.8/1.6 <sup>②</sup>	
Max. Schaltleistung - inductive load	W	80	12	80	12	12	
Response time	ms	10	<0.2	10	<0.2	<0.2	
Life of contacts (switching times) <sup>①</sup>	For all extension units of the MELSEC FX2N series: 3,000,000 at 20 VA; 1,000,000 at 35 VA; 200,000 at 80 VA (for relay output only)						
<b>Mechanical data</b>							
Weight	kg	0.65	0.65	0.85	0.85	0.85	
Dimensions (WxHxD)	mm	150x90x87	150x90x87	182x90x87	182x90x87	182x90x87	
<b>Order information</b>	Art. no.	65568	65569	66633	65571	66634	65572

<sup>①</sup> Not guaranteed by Mitsubishi Electric    <sup>②</sup> 0.8 for 4 per group and 1.6 for 8 per group  
 \* This limitation applies only per reference terminal for each group. Please observe the terminal assignments for the group identification.

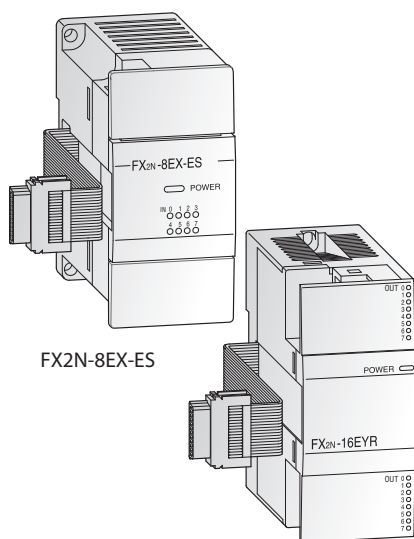

**Unpowered modular extension blocks**
 FX3S  FX3G  FX3GC  FX3GE  FX3U  FX3UC

FX2N-16EYR-ES/UL

**Extension blocks FX2N**

The FX2N series modular extension blocks are available with 8 or 16 input/output points.

It is possible to choose between relay and transistor output type.

- LEDs for indicating the input and output status
- MELSEC FX3G/FX3GC/FX3GE and FX3U series compatible
- Very compact dimensions
- Vertically terminal blocks with a cable guide to the upper or lower side

Specifications	FX2N-8 ER-ES/UL	FX2N-8 EX-ES/UL	FX2N-8 EYR-ES/UL	FX2N-8 EYT-ESS/UL	FX2N-16 EX-ES/UL	FX2N-16 EYR-ES/UL	FX2N-16 EYT-ESS/UL
<b>Electrical data</b>							
Integrated inputs/outputs	8	8	8	8	16	16	16
Nbr. of occupied I/O points in the PLC	16	8	8	8	16	16	16
Power supply	All modular extension blocks are supplied by the base unit.						
<b>Inputs</b>							
Integrated inputs	4	8	—	—	16	—	—
Min. current for logical 1	3.5 mA	3.5	—	—	3.5	—	—
Max. current for logical 0	1.5 mA	1.5	—	—	1.5	—	—
Response time	For all extension blocks of the MELSEC FX2N series: 10 ms (at time of shipment)						
<b>Outputs</b>							
Integrated outputs	4	—	8	8	—	16	16
Output type	Relay	—	Relay	Transistor	—	Relay	Transistor (source)
Switching voltage (max.)	Generally for relay version: <240 V AC, <30 V DC; for transistor version: 5–30 V DC						
Max. output current	- per output	2 A	—	2	0.5	—	2
	- per group <sup>①</sup>	8 A	—	8	0.8	—	8
Max. Schaltleistung	- inductive load	80 VA	—	80	12	—	80
Response time	ms	10	10	10	<0.2	—	10
Life of contacts (switching times) <sup>②</sup>	For all extension units of the MELSEC FX2N series: 3,000,000 at 20 VA; 1,000,000 at 35 VA; 200,000 at 80 VA (for relay output only)						
<b>Mechanical data</b>							
Weight	kg	0.2	0.2	0.2	0.2	0.3	0.3
Dimensions (WxHxD)	mm	43x90x87	43x90x87	43x90x87	43x90x87	40x90x87	40x90x87
<b>Order information</b>	Art. no.	166285	166284	166286	166287	65776	65580
						65580	65581

<sup>①</sup> This limitation applies only per reference terminal for each group. Please observe the terminal assignments for the group identification.

<sup>②</sup> Not guaranteed by Mitsubishi Electric

Note: To connect these modules to a FX3GC base unit, an adapter FX2N-CNV-IF or a power supply FX3UC-1PS-5V is required.

■ Modular extension units

FX3S  FX3G  FX3GC  FX3GE  FX3U  FX3UC

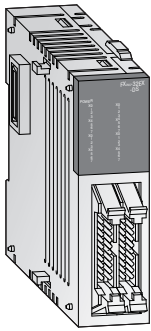

FX2NC-32EX-DS

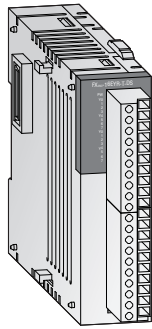

FX2NC-16EYR-DS

**Extension units FX2NC**

The modular extension units of the FX2NC series can be used in combination with FX3GC or FX3UC series base units. They are available with 16 or 32 input/output points. For modules with 16 outputs it is possible to choose between relay and transistor output type.

- Very compact dimensions
- LEDs for indicating the input and output status
- Removable terminal blocks for FX2NC-16EYR-T-DS and FX2NC-16EX-T-DS (interchangeable against optional spring terminal blocks)
- Adapter modules and system cabling sets are optionally available for units with ribbon cable connectors (transistor output types)

Specifications	FX2NC-16 EX-T-DS	FX2NC-16 EYR-T-DS	FX2NC-16 EX-DS	FX2NC-16 EYT-DSS	FX2NC-32 EX-DS	FX2NC-32 EYT-DSS
<b>Electrical data</b>						
Integrated inputs/outputs	16	16	16	16	32	32
Power supply	All modular extension blocks are supplied by the base unit.					
<b>Inputs</b>						
Integrated inputs	16	—	16	—	32	—
Input current X0→X7 / X10→∞	7/5	—	7/5	—	7/5	—
Min. current for logical 1 X0→X7/X10→∞	4.5/3.5	—	4.5/3.5	—	4.5/3.5	—
Max. current for logical 0	1.5	—	1.5	—	1.5	—
Isolation	Photocoupler isolation between input terminals and PC power for all base units					
Response time	For all extension units of the MELSEC FX2NC series: 10 ms (at time of shipment), partly adjustable between 0 and 60 ms in 1 ms steps (REF, FNC51 = 0–60 ms)					
<b>Outputs</b>						
Integrated outputs	—	16	—	16	—	32
Output type	—	Relay	—	Transistor	—	Transistor
Switching voltage (max.)	Generally for relay version: <240 V AC, <30 V DC; for transistor version: 5–30 V DC					
Max. output current - per output	—	2	—	0.1/0.3 <sup>①</sup>	—	0.1/0.3 <sup>①</sup>
- per group*	—	4/8	—	0.8	—	0.8
Max. switching power - inductive load	—	80	—	2.4/7.2 <sup>②</sup>	—	2.4/7.2 <sup>②</sup>
- lamp load	—	100	—	0.3/0.9 <sup>③</sup>	—	0.3/0.9 <sup>③</sup>
Response time	—	10	—	<0.2	—	<0.2
Life of contacts (switching times)	—	like base unit	—	—	—	—
<b>Mechanical data</b>						
Connection type	Removable screw terminal blocks		Ribbon cable connector	Ribbon cable connector	Ribbon cable connector	Ribbon cable connector
Weight	0.2	0.2	0.15	0.2	0.2	0.2
Dimensions (WxHxD)	20.2x90x89	24.2x90x89	14.6x90x87	14.6x90x87	26.2x90x87	26.2x90x87
<b>Order information</b>						
Art. no.	128152	128153	104503	104504	104505	104506

<sup>①</sup> 0.3 A for Y0 to Y1; 0.1 A all others    <sup>②</sup> 7.2 W for Y0 to Y3; 2.4 W all others    <sup>③</sup> 0.9 W for Y0 to Y3; 0.3 W all others

\* This limitation applies only per reference terminal for each group. Please observe the terminal assignments for the group identification.

Note: These modules can be combined with PLC base units of the FX3GC or FX3UC series!

**Analog output modules**

FX3S  FX3G  FX3GC  FX3GE  FX3U  FX3UC

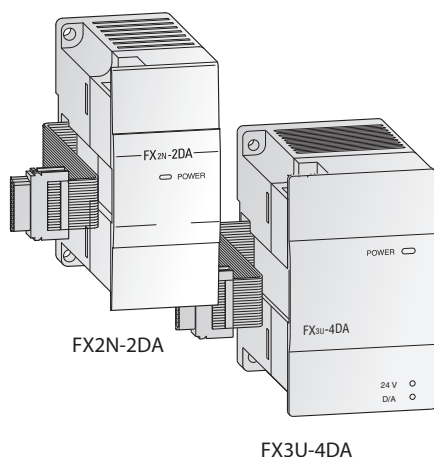

**FX2N-2DA, FX2N-4DA, FX3U-4DA**

The analog output modules provide the user with 2 to 4 analog outputs. The modules convert digital values from the FX3G-/FX3GC-/FX3GE-/

FX3U-/FX3UC controller to the analog signals required by the process. The module can output both current and voltage signals.

Specifications		FX2N-2DA	FX2N-4DA	FX3U-4DA
Analog channels	inputs	—	—	—
	outputs	2	4	4
Analog output range	0—+10 V DC/ 0—+5 V DC/ 4—+20 mA	0—+10 V DC/ 0—+5 V DC/ 4—+20 mA	-10—+10 V DC/ 0—+20 mA/ 4—+20 mA	-10—+10 V DC/ 0—+20 mA/ 4—+20 mA
	Resolution	voltage 2.5 mV (12 bit) current 4 µA (12 bit)	5 mV (10 bit) 20 µA (11 bit + sign)	0.32 mV (16 bit + sign) 0.63 µA (15 bit)
	Fullscale overall accuracy	±1 %	±1 %	±0.3—0.5 %*
Power supply	5 V DC	30 mA (from base unit)	30 mA (from base unit)	—
	24 V DC	85 mA (from base unit)	200 mA	160 mA
Related I/O points		8	8	8
Weight	kg	0.3	0.3	0.2
Dimensions (WxHxD)	mm	43x90x87	55x90x87	55x90x87
<b>Order information</b>	Art. no.	102868	65586	169509

\* Dependent on the ambient temperature

Note:  
To connect these modules to a FX3UC or FX3GC base unit, an adapter FX2N-CNV-IF or a power supply FX3UC-1PS-5V is required.

**Analog input modules**

FX3S  FX3G  FX3GC  FX3GE  FX3U  FX3UC

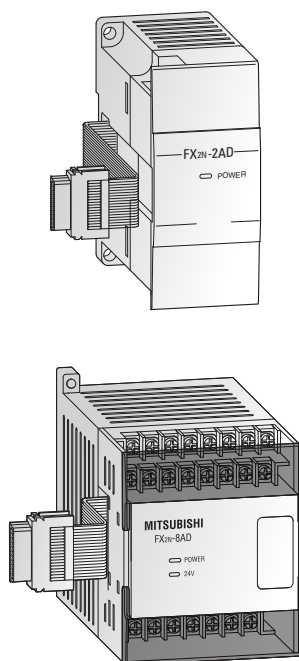

**FX2N-2AD, FX2N-4AD, FX3U-4AD, FX2N-8AD**

The analog input modules provide the user with 2 to 8 analog inputs. The module converts analog process signals into digital values which are further processed by the FX3G/FX3GC/FX3GE/FX3U/FX3UC controller.

The actual values or mean values over several measurements may be output.

Specifications		FX2N-2AD	FX2N-4AD	FX3U-4AD	FX3UC-4AD	FX2N-8AD
Analog channels	inputs	2	4	4	4	8
	outputs	—	—	—	—	—
Analog input range	0—+10 V DC/ 0—+5 V DC/ 0/4—+20 mA	0—+10 V DC/ 0—+5 V DC/ 0/4—+20 mA	-10—+10 V DC/ -20—+20 mA/ 4—+20 mA	-10—+10 V DC/ -20—+20 mA/ 4—+20 mA	-10—+10 V DC/ -20—+20 mA/ 4—+20 mA	-10—+10 V DC/ -20—+20 mA/ 4—+20 mA
	Resolution	voltage 2.5 mV, 1.25 mV/ current 4 µA (12 bit)	5 mV (11 bit + sign) 20 µA (10 bit + sign)	0.32 mV (16 bit + sign) 1.25 µA (15 bit + sign)	0.32 mV (16 bit + sign) 1.25 µA (15 bit + sign)	0.63 mV (14 bit + sign) 2.5 µA (13 bit + sign)
	Fullscale overall accuracy	±1 %	±1 %	±0.3—1 %*	±0.3—1 %*	±0.3—0.5 %*
Power supply	5 V DC	20 mA (from base unit)	30 mA (from base unit)	110 mA (from base unit)	100 mA (from base unit)	50 mA (from base unit)
	24 V DC	50 mA (from base unit)	55 mA	90 mA	80 mA	80 mA
Related I/O points		8	8	8	8	8
Weight	kg	0.3	0.3	0.2	0.13	0.4
Dimensions (WxHxD)	mm	43x90x87	55x90x87	55x90x87	20.2x90x79	75x105x75
<b>Order information</b>	Art. no.	102869	65585	169508	210090	129195

\* Dependent on the ambient temperature

Notes:  
The FX2N-8AD can be configured to accept standard analog inputs as well as selected temperature inputs such as K, T or J type thermocouples. To connect these modules to a FX3UC or FX3GC base unit, an adapter FX2N-CNV-IF or a power supply FX3UC-1PS-5V is required.

■ Combined analog I/O modules  FX3S  FX3G  FX3GC  FX3GE  FX3U  FX3UC

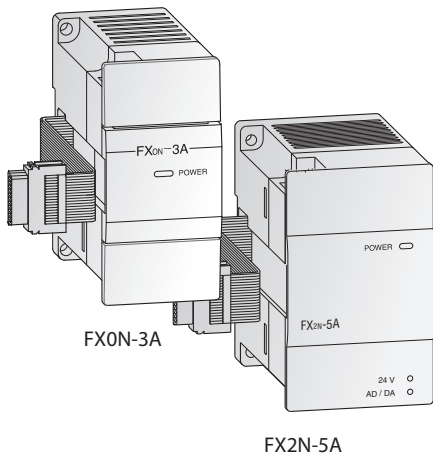

**FX0N-3A, FX2N-5A**

The analog input/output modules are available in two different models. They provide the user with 2 or 4 analog inputs and 1 analog output. They serve for conversion of analog process signals into digital values, and vice versa

For the analog inputs it can be selected between current or voltage input signal. The FX0N-3A can only be connected to a FX3U or FX3UC base unit.

Specifications		FX0N-3A	FX2N-5A
Analog channels	inputs	2	4
	outputs	1	1
Input (resolution)	voltage	0—+10 V (8 bit), 0—+5 V (8 bit)	-10—+10 V (15 bit + sign), -100—+100 mV (11 bit + sign)
	current	0/4—+20 mA (8 bit)	-20—+20 mA (14 bit + sign), 0/4—+20 mA (14 bit)
Output (resolution)	voltage	0—+10 V (8 bit), 0—+5 V (8 bit)	-10—+10 V (12 bit)
	current	4—+20 mA (8 bit)	0/4—+20 mA (10 bit)
Fullscale overall accuracy		±1 %	±0,3—1 %*
Power supply	5 V DC	30 mA (from base unit)	70 mA (from base unit)
	24 V DC	90 mA (from base unit)	90 mA
Related I/O points		8	8
Weight	kg	0.2	0.3
Dimensions (WxHxD)	mm	43x90x87	55x90x87
<b>Order information</b>		Art. no. 41790	153740

Note:  
To connect these modules to a FX3UC or FX3GC base unit, an adapter FX2N-CNV-IF or a power supply FX3UC-1PS-5V is required.

■ Analog temperature input modules  FX3S  FX3G  FX3GC  FX3GE  FX3U  FX3UC

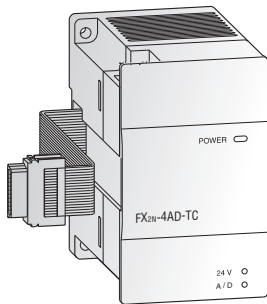

**FX2N-4AD-TC, FX2N-4AD-PT, FX2N-2LC**

The analog input module for thermocouples FX2N-4AD-TC is used for processing temperatures. It has 4 independent inputs for detecting signals from thermocouples of types J and K. The type of thermocouple can be chosen independently for each point.

The analog input module for Pt100 inputs FX2N-4AD-PT permits the connection of four Pt100 sensors to the FX3G/FX3GC/FX3GE/FX3U or FX3UC series controller.

The temperature control module FX2N-2LC reads and processes temperature signals from thermocouples and thermistors (Pt100 sensors). It is equipped with 2 separate input channels and 2 transistor output points (open collector). With these transistor outputs a temperature control by PID algorithm can be performed.

Specifications		FX2N-4AD-TC	FX2N-4AD-PT	FX2N-2LC
Analog inputs		4 (J or K type)	4 (Pt100 sensors)	2 points
Compensated temperature range	°C	-100—+600 (J type) / -100—+1200 (K type)	-100—+600	Thermocouple and Pt100 sensor
Digital outputs		-1000—+6000 (J type)/ -1000—+12000 (K type)	-1000—+6000 (12 bit conversion)	2 transistor output points
Resolution	°C	0.3 (J type)/0,4 (K type)	0.2—0.3	0.1 or 1
Fullscale overall accuracy		±0.5 % fullscale +1 °C	±1.0 % fullscale	±0.7 % (fullscale) (±0.3 % (when ambient temperature is 23 °C ±5 °C))
Power supply	5 V DC	40 mA (from base unit)	30 mA (from base unit)	70 mA (from base unit)
	24 V DC	60 mA	50 mA	55 mA
Related I/O points		8	8	8
Weight	kg	0.3	0.3	0.3
Dimensions (WxHxD)	mm	55x90x87	55x90x87	55x90x87
<b>Order information</b>		Art. no. 65588	65587	129196

Note:  
To connect these modules to a FX3UC or FX3GC base unit, an adapter FX2N-CNV-IF or a power supply FX3UC-1PS-5V is required.

**Analog temperature input adapters**

☑ FX3S ☑ FX3G ☑ FX3GC ☑ FX3GE ☑ FX3U ☑ FX3UC

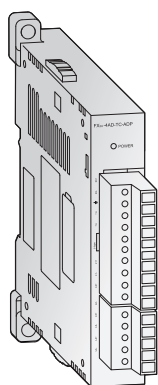

FX3U-4AD-TC-ADP

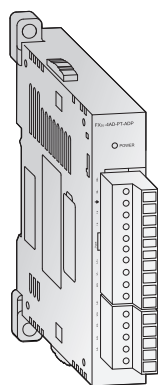

FX3U-4AD-PT-ADP

**FX3U-4AD-TC-ADP, FX3U-4AD-PT-ADP, FX3U-4AD-PTW-ADP, FX3U-4AD-PNK-ADP**

The analog input adapter for thermocouples FX3U-4AD-TC-ADP is used for processing temperatures. It has 4 independent inputs for detecting signals from thermocouples of types J and K.

The FX3U-4AD-PT-ADP, FX3U-4AD-PTW-ADP and FX3U-4AD-PNK-ADP analog input adapters enable the connection of up to four resistance thermometers to the PLC system.

Specifications	FX3U-4AD-TC-ADP	FX3U-4AD-PT-ADP	FX3U-4AD-PTW-ADP	FX3U-4AD-PNK-ADP
Analog inputs	4 (thermocouples, J or K type)	4 (Pt100)	4 (Pt100)	4 (Pt1000 or Ni1000)
Compensated temperature range	-100—+600 (J)/ -100—+1000 (K)	-50—+250	-100—+600	-50—+250 (Pt1000)/ -40—+110 (Ni1000)
Digital outputs	-1000—+6000 (J)/ -1000—+10000 (K)	-500—+2500	-1000—+6000	-500—+2500 (Pt1000)/ -400—+1100 (Ni1000)
Resolution	0.3 (J)/0.4 (K)	0.1	0.2—0.3	0.1
Fullscale overall accuracy	±0.5 % (fullscale)	±0.5—1.0 % (fullscale)*		
Power supply	5 V DC	15 mA (from base unit)	15 mA (from base unit)	15 mA (from base unit)
	24 V DC	45 mA	50 mA	50 mA
Related I/O points	0	0	0	0
Weight	kg	0.1	0.1	0.1
Dimensions (WxHxD)	mm	17.6x90(106)x89.5		
<b>Order information</b>	Art. no.	165273	165272	214173
			214172	

\*Dependent on the ambient temperature

Note:

When connecting the analog adapters to a FX3G, FX3S or FX3U base unit, a communications adapter is required. A direct connection without adapter is possible if these modules are connected to a FX3GC, FX3GE or FX3UC base unit.

**Analog I/O adapters**

☑ FX3S ☑ FX3G ☑ FX3GC ☑ FX3GE ☑ FX3U ☑ FX3UC

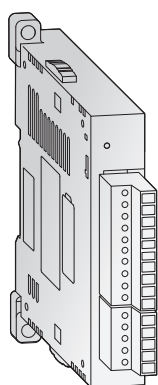

FX3U-4AD-ADP

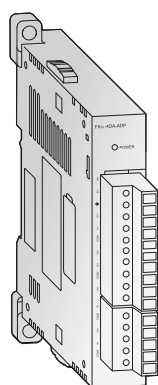

FX3U-4DA-ADP

**FX3U-4AD-ADP, FX3U-4DA-ADP, FX3U-3A-ADP**

The analog input adapter for thermocouples FX3U-4AD-TC-ADP is mounted on the left side of the base unit and extends a controller of the FX3 series with up to 4 analog inputs.

The analog output adapter FX3U-4DA-ADP is mounted on the left side of a FX3 series base unit and provides four analog outputs.

The analog input/output module FX3U-3A-ADP provides the user with two analog inputs and one analog output.

Specifications	FX3U-4AD-ADP	FX3U-4DA-ADP	FX3U-3A-ADP
Analog channels	inputs	4	2
	outputs	—	4
Analog range	0—+10 V DC, 4—+20 mA	0—+10 V DC, 4—+20 mA	0—+10 V CC, 4—+20mA
Resolution	2.5 mV/10 μA (12 bit/11 bit)	2.5 mV/4 μA (12 bit)	2.5 mV/4 μA (12 bit)
Overall accuracy	±0.5 % */±1 %	±0.5 % */±1 %	±0.5—1 %*
Power supply	5 V DC	15 mA (from base unit)	15 mA (from base unit)
	24 V DC	40 mA	150 mA
Related I/O points	0	0	0
Weight	kg	0.1	0.1
Dimensions (WxHxD)	mm	17.6x90(106)x89.5	17.6x90x89.5
<b>Order information</b>	Art. no.	165241	165271
			221549

\*Dependent on the ambient temperature and signal quality

Note:

When connecting the analog adapters to a FX3G, FX3S or FX3U base unit, a communications adapter is required. A direct connection without adapter is possible if these modules are connected to a FX3GC, FX3GE or FX3UC base unit.

■ Temperature control module  FX3S  FX3G  FX3GC  FX3GE  FX3U  FX3UC

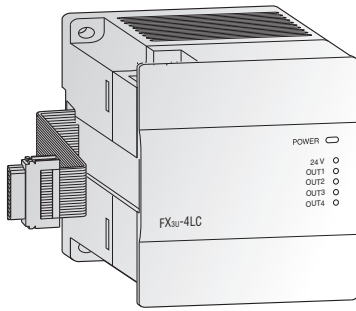

**Temperature control module**

The temperature control module FX3U-4LC is equipped with four temperature input points and four transistor (open collector) output points. It is used to read temperature signals from thermocouples and Pt100 sensors, and performs PID output control.

The proportional band, the integral time and the derivative time can be easily set by auto tuning. The channels are isolated against each other. Self-diagnosis functions are provided, and the disconnection of heaters can be detected by current detection (CT).

Specifications	FX3U-4LC	
Analog inputs	4 (Thermocouple and Pt100 sensors)	
Compensated temperature range	°C	-200—+2300
Digital outputs	4 NPN transistor open collector output points	
Resolution	°C	0.1 or 1
Fullscale overall accuracy	±0.3–0.7 % (fullscale, dependent on the ambient temperature)	
Power supply	5 V DC	160 mA (from base unit)
	24 V DC	50 mA
Related I/O points	8	
Dimensions (WxHxD)	mm	90x90x86
<b>Order information</b>	Art. no.	232806

Note:

To connect these modules to a FX3UC or FX3GC base unit, an adapter FX2N-CNV-IF or a power supply FX3UC-1PS-5V is required.

■ Data logger module  FX3S  FX3G  FX3GC  FX3GE  FX3U  FX3UC

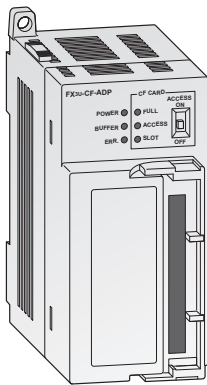

**Data logger module**

The FX3U-CF-ADP is a general purpose data logging adapter. The difference to other available logging units is that the PLC main unit controls the data logging based on user requirements, e.g. periodical or even based. For tracing a timestamp is automatically added to all data storages, that eases alarm and other time critical logging.

Another usage is the storage of bigger recipe data. A CompactFlash® memory card up to 2GB can be used. Six applied instructions allow all kinds of data writing, manipulation or reading, making this adapter the optimum solution towards customer requirements.

Specifications	FX3U-CF-ADP	
Data access method	Controlled by the main unit, no polling from the logging unit possible.	
Connectable units	A maximum of one FX3U-CF-ADP can be connected per PLC.	
Time stamp function	The real time clock data of the base unit is used.	
Recommended storage media	CompactFlash® memory card (GT05-MEM-256MC, -512MC, -1GC, -2GC)	
Max. file size	512 MB	
File format	CSV	
Max. numbers of files	63 (Plus one FIFO file.)	
FIFO function	One pattern (The file name gets automatically generated.)	
Power supply	24 V DC	130 mA
Related I/O points	kg	0
Dimensions (WxHxD)	mm	45x90x89.5
<b>Order information</b>	Art. no.	230104

High-speed counter modules

FX3S  FX3G  FX3GC  FX3GE  FX3U  FX3UC

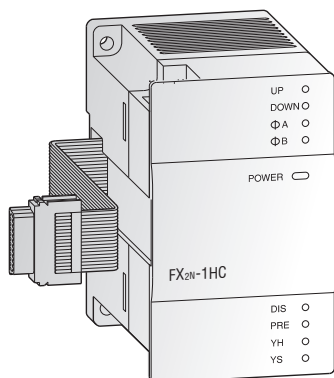

**FX2N-1HC, FX2NC-1HC, FX3U-2HC**

In addition to the internal high-speed MELSEC FX counters, the high-speed counter modules FX2N-1HC, FX2NC-1HC and FX3U-2HC provide the user with an external counter. It counts 1- or 2-phase pulses up to a frequency of 200 kHz. The counting range covers either 16 or 32 bit.

The two integrated transistor outputs can be switched independently of one another by means of internal comparison functions. Hence, simple positioning tasks can also be realized economically. In addition, the modules can be used as a ring counter.

Specifications	FX2N-1HC	FX2NC-1HC*	FX3U-2HC
Counter inputs	2 (1 phase) or 1 (2 phase)	2 (1 phase) or 1 (2 phase)	2 (1 phase) or 1 (2 phase)
Max. counting frequency	kHz 50	50	200/100/50
Signal level	5, 12, 24 V DC/7 mA	5, 12, 24 V DC/7 mA	5, 12, 24 V DC
Input format	bit 16, 32	16, 32	—
Type of counter	Up/down counter, ring counter	Up/down counter, ring counter	Up/down counter, ring counter
Counting range	16 bit	0–65535	0–65535
	32 bit	-2147483648–+2147483647	-2147483648–+2147483647
Output type	2 x transistor (5–24 V DC; 0.5 A)	2 x transistor (5–24 V DC; 0.5 A)	2 x transistor (5–24 V DC; 0.5 A)
Power supply	5 V DC	90 mA (from base unit)	90 mA (from base unit)
	24 V DC	—	—
Related I/O points	8	8	8
Weight	kg 0.3	0.13	0.08
Dimensions (WxHxD)	mm 55x90x87	20.2x90x89	55x90x87
<b>Order information</b>	Art. no. 65584	217916	232805

\*The FX2NC 1HC can only be connected to a FX3UC base unit.

High-speed counter adapters

FX3S  FX3G  FX3GC  FX3GE  FX3U  FX3UC

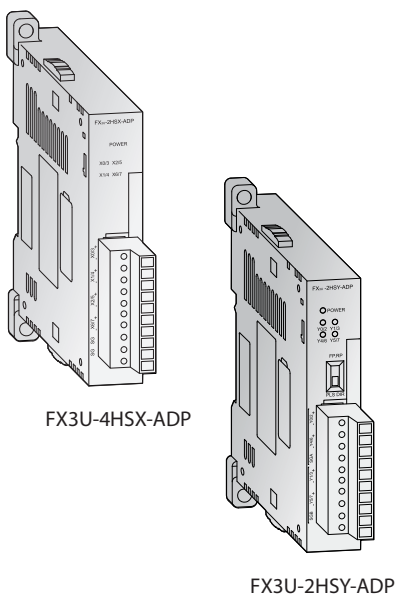

**FX3U-4HSX-ADP, FX3U-2HSY-ADP**

These adapter modules allow direct processing of positioning application data.

FX3U-2HSY-ADP delivers 2 channels of pulse train outputs up to 200 kHz.

The FX3U-4HSX-ADP provide high speed counter inputs up to 200 kHz while the

Specifications	FX3U-4HSX-ADP	FX3U-2HSY-ADP
Maximum connectivity	2	2
Counter	inputs	4
	outputs	—
Max. counting frequency	inputs	1 ch 1 input or 1 ch 2 inputs: 200 kHz
	outputs	2 ch 2 inputs: 100 kHz
Input format	Differential line receiver (AM26C32 is suitable) Photocoupler isolation on inputs	—
Output format	—	Differential line driver (AM26C31 is suitable) Normal rotation pulse train, reverse pulse train or pulse train + one
Maximum cable length	m 10	10
Input potential	5 V DC	—
Output load	—	less than 25 mA
Power supply	5 V DC	30 mA (from base unit)
	24 V DC	30 mA (from base unit)
Related I/O points	0	0
Weight	kg 0.08	0.08
Dimensions (WxHxD)	mm 17.6x90(106)x89.5	17.6x90(106)x89.5
<b>Order information</b>	Art. no. 165274	165275

Note:  
The adapters FX3U-□-ADP can only be used with the FX3U and they require a function extension board.

## ■ Single-axis positioning modules

FX3S  FX3G  FX3GC  FX3GE  FX3U  FX3UC

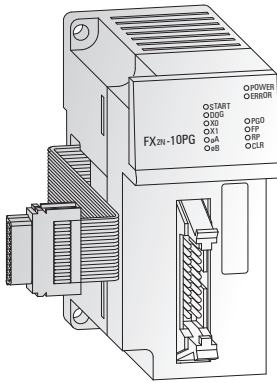

### FX3U-1PG, FX2N-10PG

The positioning modules FX3U-1PG and FX2N-10PG are extremely efficient single-axis positioning modules for controlling either step drives or servo drives (by external regulator) with a pulse chain. They are very suitable for achieving accurate positioning in combination

with the MELSEC FX series. The configuration and allocation of the position data are carried out directly via the PLC program. A very wide range of manual and automatic functions are available to the user.

Specifications	FX3U-1PG	FX2N-10PG
Accessible axes	1	1
Output frequency	Impulse/s 10–200 000	1–1 000 000
Signal level for digital inputs	24 V DC/40 mA	5 V DC/100 mA; 24 V DC/70 mA
Power supply	5 V DC 150 mA (from base unit) 24 V DC —	120 mA (from base unit) —
Related I/O points	8	8
Weight	kg 0.3	0.2
Dimensions (WxHxD)	mm 43x90x87	43x90x87
<b>Order information</b>	Art. no. 259298	140113

## ■ Positioning module for SSCNET

FX3S  FX3G  FX3GC  FX3GE  FX3U  FX3UC

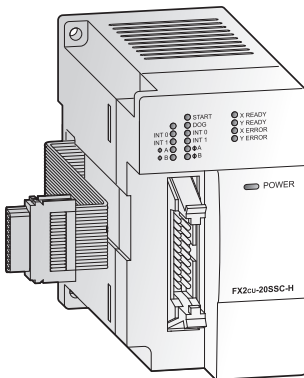

### SSCNETIII-Modul FX3U-20SSC-H

The SSCNET module FX3U-20SSC-H can be used in combination with a FX3U or FX3UC programmable controller to achieve a cost effective solution for high precision, high speed positioning. The plug-and-play fiber optic SSCNET cabling reduces setup time and increases control distance for positioning operations in a wide range of applications.

Servo parameters and positioning information for the FX3U-20SSC-H are easily set up with an FX3U/FX3UC base unit and a personal computer. For parameter setting, monitoring and testing the easy programming software FX Configurator-FP is available.

Specifications	FX3U-20SSC-H
Accessible axes	2 (independent or interpolation)
Output frequency	1 Hz to 50 MHz
Pulse output format	SSCNETIII (servo bus)
Communications speed	50 Mbps
Starting time	ms 1.6 (+1.7 SSCNET cycle time)
Max. to PLC connectable modules	Up to 8 can be connected to the FX3U PLC
Status displays	Power, module status, axis status, error
Power supply	5 V DC 100 mA 24 V DC —
Related I/O points	8
Weight	kg 0.3
Dimensions (WxHxD)	mm 55x90x87
<b>Order information</b>	Art. no. 231512

#### Note:

The FX3U-20SSC-H can be used in combination with a FX3U or FX3UC base unit only. Please refer to the Mitsubishi Electric MELSERVO catalog for suitable servo motors and amplifiers.



■ Network modules for CC-Link □ FX3S  FX3G  FX3GC  FX3GE  FX3U  FX3UC

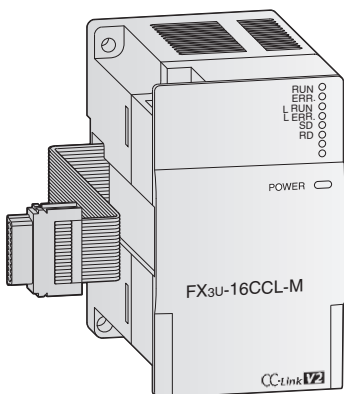

**CC-Link master module FX3U-16CCL-M**

The CC-Link network enables the controlling and monitoring of decentralized I/O modules at the machine.

The CC-Link master module FX3U-16CCL-M is a special extension module, which assigns an FX3G, FX3GC, FX3GE, FX3U or FX3UC series PLC as the master station of a CC-Link system.

The setting of all modules within the network is handled directly via the master module.

The maximum communications distance is 1200 m without repeater.

Specifications		FX3U-16CCL-M
Module type		Master station
Link points per station	I/O points	32
	register	8
Max. number of I/O points		FX3G/FX3GC/FX3GE: 32 x nbr. of stations ≤128 FX3U/FX3UC: 32 x nbr. of stations ≤256*
Number of connectable modules		max. 16
Power supply	5 V DC	—
	24 V DC	240 mA
Related I/O points		8
Weight	kg	0.4
Dimensions (WxHxD)	mm	55x90x87
<b>Order information</b>		Art. no. 248224

\*Total of I/O points in base unit and extension units within the CC-Link network ≤384.

Note:  
To connect these modules to a FX3UC or FX3GC base unit, an adapter FX2N-CNV-IF or a power supply FX3UC-1PS-5V is required.  
More informations about CC-Link are available in various other publications from Mitsubishi Electric.

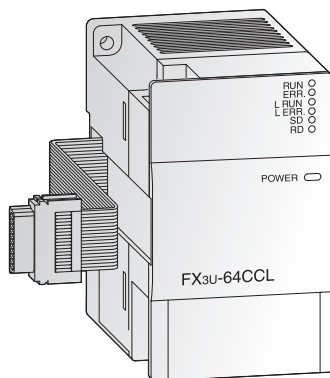

**FX3U-64CCL interface module**

The FX3U-64CCL CC-Link interface module is available for FX3G, FX3GC, FX3GE, FX3U or FX3UC series main units and enables CC-Link V2

functionality, for example expanded cyclic transmission which facilitates handling of multiple data processes.

Specifications		FX3U-64CCL
Module type		Intelligent device station
Link points per station	I/O points	128 (Occupying 1 station with Octuple expanded cyclic setting)
	register	32 (Occupying 1 station with Octuple expanded cyclic setting)
Max. transmission speed		10 Mbps
Related I/O points		8
Power supply	24 V DC	24 V DC/220 mA
Weight	kg	0.3
Dimensions (WxHxD)	mm	55x90x87
<b>Order information</b>		Art. no. 217915

Note:  
When attaching the FX3U-64CCL to a FX3UC/FX3GC base unit, the FX2NC-CNV-IF interface converter or the FX3UC-1PS-5V power supply unit is required.  
More informations about CC-Link are available in various other publications from Mitsubishi Electric.

**Network module for CC-Link**  FX3S  FX3G  FX3GC  FX3GE  FX3U  FX3UC

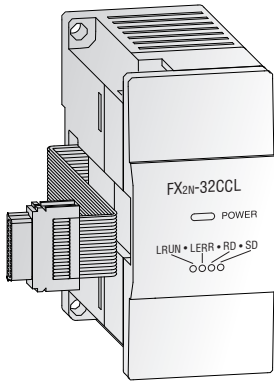

**CC-Link communication module FX2N-32CCL**

The communication module FX2N-32CCL enables the user to connect to the CC-Link network with a superior PLC system as master CPU. This gives him access to the network of all MELSEC PLC systems and frequency inverters and to additional products from other suppliers. Thus the network is expandable via the digital inputs/outputs of the FX modules to a maximum of 256 I/Os.

The buffer memory of the FX2N-32CCL is read and written by FROM/TO instructions. The connection is to the extension bus on the right side of the controller.

Specifications		FX2N-32CCL
Module type		Remote station
Link points per station	I/O points	32
	register	8
Max. number of I/O points		—
Number of connectable modules		—
Power supply	5 V DC	max. 130 mA (from base unit)
	24 V DC	50 mA
Related I/O points		8
Weight	kg	0.3
Dimensions (WxHxD)	mm	43x90x87
<b>Order information</b>	Art. no.	102961

**Notes:**  
To connect this module to a FX3UC or FX3GC base unit, an adapter FX2N-CNV-IF or a power supply FX3UC-1PS-5V is required. More informations about CC-Link are available in various other publications from Mitsubishi Electric.

**Network module for Ethernet**  FX3S  FX3G  FX3GC  FX3GE  FX3U  FX3UC

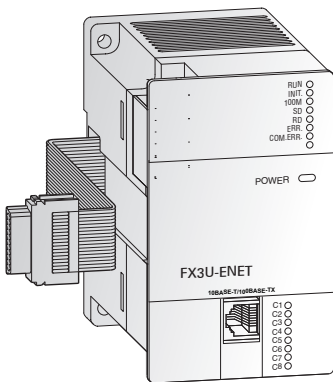

**Ethernet communications module FX3U-ENET**

The FX3U-ENET communications module provides the FX3G, FX3GE, FX3U or FX3UC with a direct connection on to an Ethernet network. With the FX3U-ENET installed an FX3G/FX3GE/FX3U/FX3UC PLC can exchange data quickly and easily with process visualization systems in

addition to supporting full program UP/DOWN load as well as comprehensive monitoring support. The module also supports Peer to Peer connection and MC Protocol. It is easily set-up with the FX Configurator-EN software.

Specifications		FX3U-ENET/FX3U-ENET-P502
Protocol		TCP/IP, UDP
Communication mode		Full-duplex/half-duplex
No. of simultaneous open connections		8
Fixed buffer communication		1023 word x 8
Communication with mail server		SMTP, POP3
Interface		IEEE802.3u (100BaseTX), IEEE802.3 (10BaseT)
Connector		RJ45
Max. transfer rate		100 Mbits/s, 10 Mbit/s
Max. segment length	m	100
Cable		CAT5 STP or 3 STP
Power supply	5 V DC	—
	24 V DC	240 mA (from base unit)
Related I/O points		8
Weight	kg	0.3
Dimensions (WxHxD)	mm	55x90x87
<b>Order information</b>	Art. no.	166086/225142

**Note:**  
To connect this module to a FX3UC base unit, an adapter FX2N-CNV-IF or a power supply FX3UC-1PS-5V is required.

## Network module for Ethernet

FX3S  FX3G  FX3GC  FX3GE  FX3U  FX3UC

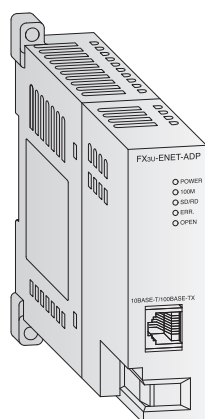

### Ethernet communications adapter FX3U-ENET-ADP

The FX3U-ENET-ADP communications adapter is an Ethernet interface with 10BASE-T specifications for the FX3G, FX3GC, FX3S or FX3U series.

The FX3U-ENET-ADP enables upload, download, monitor and test sequence of programs via Ethernet from a personal computer (GX Works2 or MX Components have to be installed).

Specifications	FX3U-ENET-ADP
Protocol	TCP/IP
No. of simultaneous open connections	1
Interface	IEEE802.3u (10BaseTX), IEEE802.3 (10BaseT)
Connector	RJ45 (to Ethernet), 3 screw terminals (to ground)
Max. transfer rate	10 Mbit/s, 100 Mbit/s
Cable	CAT5 STP or 3 STP
Power supply	5 V DC 24 V DC
	30 mA (from base unit) —
Related I/O points	0
Weight	kg 0.1
Dimensions (WxHxD)	mm 23x90(106)x81.5
<b>Order information</b>	Art. no. 248844

**Note:**  
This module can be connected directly (without adapter) to a base unit of the FX3GC or FX3UC series. To connect this module to a FX3G, FX3S or FX3U base unit, an adapter is required.

## Network module for Profibus DP

FX3S  FX3G  FX3GC  FX3GE  FX3U  FX3UC

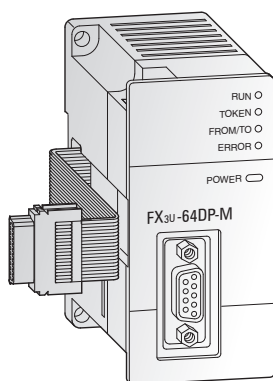

### Master modul FX3U-64DP-M

The FX3U-64DP-M Profibus DP master module enables you to integrate a MELSEC FX3U or FX3UC PLC system as a class 1 master of a Profibus DP network.

This interface module provides your FX3U/ FX3UC base unit with an intelligent Profibus DP link for the implementation of decentralised control tasks.

The FX3U Profibus DP master provides comprehensive data and alarm processing to the Profibus DP V1 standard. It is easily set up with the GX Configurator-DP software.

Specifications	FX3U-64DP-M
Module type	Master station
Transmission type	Bus network
Transmission data	32 byte/slave (normal service mode) 244 byte/slave (extended service mode)
Interface	Profibus DP (with 9 pole D-SUB connector)
Max. number of master per configuration	max. 1
Repeaters	3
Max. number of slaves	64
Communications speed	Profibus standard
Communications distance	m max. 1200 (depends on communication speed)
Communication cable	Profibus cable with 9-pin D-SUB connector
Power supply	5 V DC 24 V DC
	— max. 155 mA (from base unit)
Related I/O points	8
Weight	kg 0.2
Dimensions (WxHxD)	mm 43x90x87
<b>Order information</b>	Art. no. 166085
<b>Accessories</b>	Profibus connector up to 12 Mbaud: PROFICON-PLUS, art. no. 140008 or PROFICON-PLUS-PG, art. no. 140009

**Note:**  
The FX3U-64DP-M can be used in combination with a FX3U or FX3UC base unit only. To connect this module to a FX3UC base unit, an adapter FX2NC-CNV-IF or a power supply FX3UC-1PS-5V is required.

■ Network module for Profibus DP □ FX3S  FX3G  FX3GC  FX3GE  FX3U  FX3UC

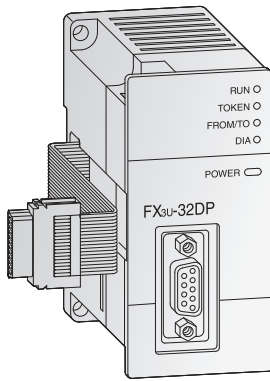

**FX3U-32DP Profibus DP slave module**

The FX3U-32DP Profibus DP slave module is available for FX3G, FX3GC, FX3GE, FX3U and FX3UC series main units and allows the attached FX main unit to function as a slave station on a Profibus DP-V1 network.

Profibus DP-V1 functionality supports extensive alarm processing and messaging on top of standard cyclic data exchange.

Specifications	FX3U-32DP
Module type	Slave station
Transmission type	Bus network
Transmission data	max. 144 bytes
Interface	9-pin D-SUB for Profibus DP
Max. number of slave stations per configuration	8
Communication speed	5 V DC
Communication distance	24 V DC
Communication cable	max. 12 Mbit/s
Related I/O points	max. 1200 (depends on communication speed)
Power supply	Profibus cable with 9-pin D-SUB connector
Weight	8
Dimensions (WxHxD)	24 V DC/145 mA (from base unit)
	kg
	mm
	0.2
	43x90x89
<b>Order information</b>	Art. no. 194214

Note:  
To connect a FX3U-32DP to a FX3UC/FX3GC base unit, an adapter FX2NC-CNV-IF or a power supply FX3UC-1PS-5V is required.

■ Remote I/O station for Profibus DP □ FX3S  FX3G  FX3GC  FX3GE  FX3U  FX3UC

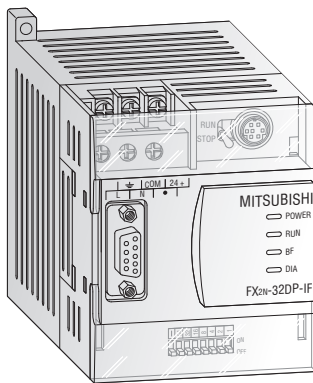

**Remote I/O station FX2N-32DP-IF**

The remote I/O station FX2N-32DP-IF forms an extremely compact communication unit and provides a connection of I/O modules with up to 256 I/O points and/or up to 8 special function modules as an alternative.

The FX2N-32DP-IF includes a 240 V power supply unit and a 24 V service voltage terminal, e.g. for analog modules. The FX2N-32DP-IF-D is supplied with 24 V DC.

It features an entire electrical isolation of the Profibus DP connector and of the sensor/actuator circuits.

Profibus data such as the baud rate or I/O data can be monitored directly with the programming software or on the hand-held programming units FX-10P/FX-20P/FX-30P. This facilitates an easy error diagnosis directly on the remote I/O station.

Specifications	FX2N-32DP-IF	FX2N-32DP-IF-D
Power supply	100–240 V AC (+10 %/-15 %) 50/60 Hz	24 V DC (+20 %/-30 %)
Power consumption	30 VA	14 W
Internal current consumption	5 V DC/max. 220 mA (from base unit), 24 V DC/500 mA	5 V DC/max. 220 mA (from base unit)
Interface (connectors)	9-pin D-SUB for Profibus DP, 8-pin Mini-DIN for PC or programming unit FX-10P/FX-20P/FX-30P	
Communication speed	distance	
	1200 m	kbps 9.6/19.2/45.45/93.75
	1000 m	kbps 187.5
	400 m	kbps 500
	200 m	kbps 1500
100 m	kbps 3000/6000/12000	
Communication distance	m	max. 1200 (depends on communication speed)
Communication cable	Profibus cable with 9-pin D-SUB connector	
Max. number of controllable I/O points	256	
Weight	kg	0.4
Dimensions (WxHxD)	mm	75x98x87
<b>Order information</b>	Art. no. 145401	142763

**Network module for DeviceNet**  FX3S  FX3G  FX3GC  FX3GE  FX3U  FX3UC

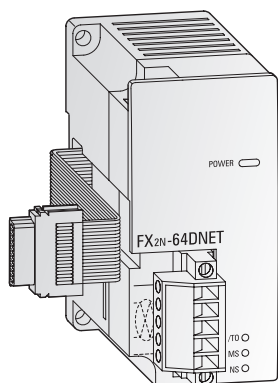

**DeviceNet slave module FX2N-64DNET**

The DeviceNet slave module FX2N-64DNET can be used to connect FX3G, FX3GC, FX3GE and FX3U programmable controllers to a DeviceNet network.

The FX2N-64DNET can communicate to the master by the master/slave communication (using the master/slave I/O connection), and

to other nodes supporting the UCMM connection by client/server communication (using the UCMM connection).

The communication between the programmable controller and the internal buffer memory of the FX2N-64DNET is handled by FROM/TO instructions.

Specifications		FX2N-64DNET	
Module type		Slave (group 2)	
Node type		G2 server	
Station numbers		0–63 points	
Supported communication speeds	kbps	125/250/500	
Communication data (open connection)	Master/slave	no. of connections	1 connection (group 2)
		transfer time-out	2,000 ms (ACK time-out)
	UCMM client/server	no. of connections	63/63 (group 1, 3)
Communication data (I/O connection)		data length	max. 64 bytes per connection
		type	Polling, cyclic, change of state
		data length	max. 64 bytes (fragmentation is possible)
Module ID code		K7090	
Status displays		Power, module status, network status	
Related I/O points		8	
Power supply		5 V DC	120 mA
		24 V DC	50 mA
Weight	kg	0.2	
Dimensions (WxHxD)	mm	43x90x87	
<b>Order information</b>	Art. no.	131708	

**Network module for CANopen**  FX3S  FX3G  FX3GC  FX3GE  FX3U  FX3UC

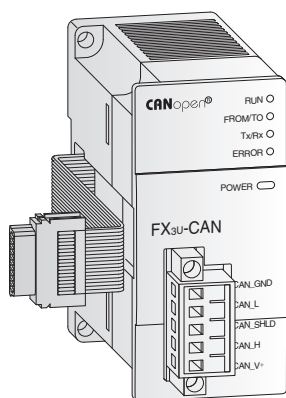

**CANopen master module FX3U-CAN**

The FX3U-CAN communications module makes it possible to connect a FX3G, FX3GC, FX3GE, FX3U or FX3UC PLC to an existing CANopen network.

In addition to real-time capabilities and high-speed data transfer at rates of up to 1 Mbit/s the CANopen module also shines with high transfer reliability and simple network configuration.

Up to 320 process data objects (PDOs) can be sent or received. The CANopen Profile CiA 405 V2.0 and CiA 417 V2.0 are supported.

Communication with the module's memory buffer is performed with simple FROM/TO instructions.

Specifications		FX3U-CAN	
Module type		CANopen master	
CAN standard		ISO 11898/1993	
CANopen standard by CiA		DS-301 version 3.0	
Additional CANopen features		NMT, Guarding, and Guarding request based on DS-302 V2.0. network variables based on DS-405 V1.0	
Max. number of modules that can be connected to the network		30 without repeater; 127 with repeater	
Station numbers		1–127	
Supported communication speeds	kbps	10, 20, 50, 125, 250, 500, 800, 1000	
Status displays		RUN, Error, Power, Network status	
Power supply		5 V DC	290 mA
		24 V DC	—
Related I/O points		8	
Weight	kg	0.2	
Dimensions (WxHxD)	mm	43x90x88.7	
<b>Order information</b>	Art. no.	141179	

Note:  
To connect this module to a FX3UC/FX3GC base unit, an adapter FX2NC-CNV-IF or a power supply FX3UC-1PS-5V is required.

■ Network module for J1939  FX3S  FX3G  FX3GC  FX3GE  FX3U  FX3UC

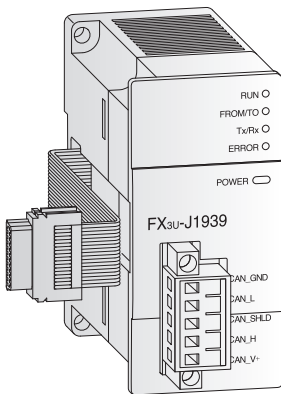

**Network module for J1939**

The FX3U-J1939 communication module allows the connection of FX3G/FX3U/FX3UC series PLCs to a J1939 network. J1939 is a CAN based protocol used for communication with motors, generators and compressors.

In a J1939 network are no master or slave stations. All nodes may receive each others' messages. Standard messages contain up to 8 bytes of data, extended messages contain up to 250 bytes of data.

Up to 75 standard messages and 4 extension messages can be sent and received.

The FX3U-J1939 is compatible with CAN Layer 2 communication. In this mode, a FX3U-J1939 can send and receive up to 42 messages on a CAN network.

Specifications	FX3U-J1939
Communication standard version	J1939
Network node size	J1939: 2–30 NMEA2000*: 2–50
Communication method	Cyclic, acyclic or request driven (user configurable)
CAN layer-2 communication	Send and receive
Max. cable length	m 5000
Baud rates	kbit/s 10, 20, 50, 100, 125, 250, 500, 800, 1000
Power supply	24 V DC/110 mA (from base unit)
Weight	kg 0.2
Dimensions (WxHxD)	mm 43x90x95
<b>Order information</b>	Art. no. 254276

Note:  
To connect this module to a FX3UC base unit, an adapter FX2NC-CNV-IF or a power supply FX3UC-1PS-5V is required.

■ Modbus & serial communication special adapter  FX3S  FX3G  FX3GC  FX3GE  FX3U  FX3UC

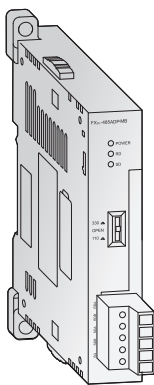

**Active data module (RS485)**

The addition of an active data interface module permits active communication between the PLC and surrounding devices.

With RS485 communication can be configured as either 1:N multidrop, parallel link or peer to peer operation.

FX3U-485ADP-MB also supports Modbus RTU and Modbus ASCII.

Specifications	FX3U-485ADP-MB
Interface	RS485; Modbus RS485
Communication speed*	kbits 0.3–19.2
Max. communication distance	m 500
Power supply	5 V DC 24 V DC 20 mA (from base unit) —
Related I/O points	0
Dimensions (WxHxD)	mm 17.6x90(106)x74
<b>Order information</b>	Art. no. 206191

\* Speed depends on communication method (Parallel link, N:N Network, No protocol, Dedicated protocol etc.)

Note:  
This adapter module can be connected directly (without special adapter) to a base unit of the FX3GC, FX3GE or FX3UC series. To connect this adapter module to a FX3G, FX3S or FX3U base unit, an adapter is required.

**Interface module**  FX3S  FX3G  FX3GC  FX3GE  FX3U  FX3UC

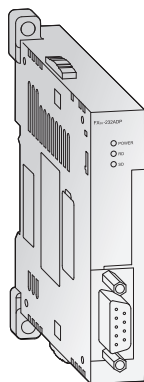

**Active data interface module FX3U-232ADP-MB**

The additional active data interface module permits active communication between the PLC and surrounding RS232C peripherals. All device information can be sent or received via these interfaces.

The module is suitable for the connection of printers, bar code readers, PCs and other PLC systems. The communication is handled by the PLC program using the RS instruction.

The connection is to the communications bus on the left side of the controller. The internal serial RS422 interface is also fully available.

The FX3U-232ADP-MB can also be used for communication via MODBUS.

Specifications		FX3U-232ADP-MB
Interface		RS232C with 9 pole D-SUB connector (photocoupler isolation)
Communication speed*	kbps	0.3–115.2
Power supply	5 V DC	30 mA (from base unit)
	24 V DC	—
Related I/O points		0
Weight	kg	0.08
Dimensions (WxHxD)	mm	17.6x90(106)x81.5
<b>Order information</b>		
	Art. no.	206190

\* Speed depends on communication method (No protocol, Dedicated protocol, Protocol for programming tool)

Note:  
This module can be connected directly (without adapter) to a base unit of the FX3GC, FX3GE or FX3UC series. To connect this module to a FX3G, FX3S or FX3U base unit, an adapter is required.

**Interface module**  FX3S  FX3G  FX3GC  FX3GE  FX3U  FX3UC

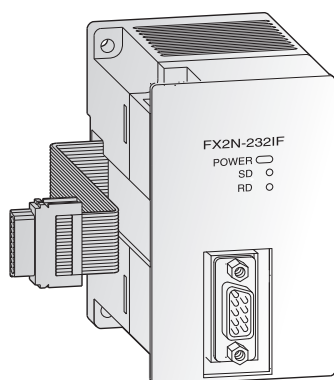

**Interface module FX2N-232IF**

The interface module FX2N-232IF provides an RS232C interface for serial data communications with the MELSEC FX3U and FX3UC.

Communication with PCs, printers, modems, barcode readers etc. is handled by the PLC program.

The send and receive data are stored in the FX2N-232IF's own buffer memory.

Specifications		FX2N-232IF
Interface		RS232C with 9 pole D-SUB connector (photocoupler isolation)
Communication speed	kbps	0.3–19.2
Communication distance	m	max. 15
Communication cable		Shielded cable
Communication mode		Full duplex
Protocols		Non protocol mode/start stop synchronisation
Send and receive buffer		512 byte each
Format		7 or 8 bits, parity none/even/odd, stop bits: 1 or 2
Power supply	5 V DC	40 mA (from base unit)
	24 V DC	80 mA
Related I/O points		8
Weight	kg	0.3
Dimensions (WxHxD)	mm	55x90x87
<b>Order information</b>		
	Art. no.	66640

Note:  
To connect this module to a FX3UC base unit, an adapter FX2NC-CNV-IF or a power supply FX3UC-1PS-5V is required.

■ Digital extension adapter boards  FX3S  FX3G  FX3GC  FX3GE  FX3U  FX3UC

**Extension adapters FX3G-4EX-BD, FX3G-2EYT-BD**

The extension adapters for the FX3G series are available with 4 inputs or 2 outputs. They are installed directly in the controller of the FX3S or FX3G series and therefore do not require any additional installation space.

These adapters are especially advantageous when only few additional I/Os are required and there is not enough room for an adjacent module to be installed.

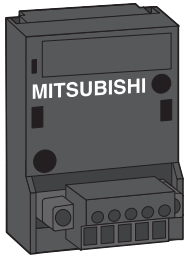

FX3G-4EX-BD

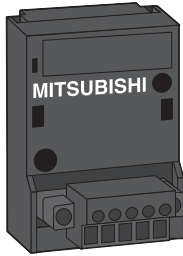

FX3G-2EYT-BD

Specifications	FX3G-4EX-BD	FX3G-2EYT-BD
Applicable for	Base units FX3S/FX3G	
Integrated inputs/outputs	4	4
Power supply	From base unit	
Integrated inputs	4	—
Integrated outputs	—	2
Input level		
voltage	24 V DC (+20 %/-15 %)	
current	5 mA (24 V DC)	
Output type	—	Transistor
Max. switching voltage	V	5–30 V DC
Weight	kg	0.02
Dimensions (WxHxD)	mm	35x51.2x29.2
<b>Order information</b>	Art. no.	
	271700	271701

■ Analog adapter boards  FX3S  FX3G  FX3GC  FX3GE  FX3U  FX3UC

**Analog adapter boards FX3G-1DA-BD and FX3G-2AD-BD**

The analog input adapter board FX3G-2AD-BD provides the user with 2 analog inputs. The board converts analog process signals into digital values which are further processed by the MELSEC FX3S/FX3G/FX3GE controller.

The analog adapter FX3G-1DA-BD provides the user with 1 analog output. This module converts digital values from the FX3S/FX3G/FX3GE controller to the analog signals required by the process.

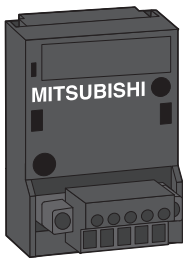

FX3G-2AD-BD

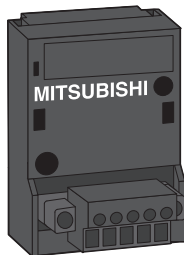

FX3G-1DA-BD

Specifications	FX3G-2AD-BD	FX3G-1DA-BD
Applicable for	Base units FX3S/FX3G/FX3GE	Base units FX3S/FX3G/FX3GE
Power supply	From base unit	From base unit
Analog channels		
inputs	2	—
outputs	—	1
Analog input range	0–+10 V DC/4–+20 mA	0–+10 V DC/4–+20 mA
Input resistance		
voltage input	kΩ 198.7	—
current input	Ω 250	—
External load		
voltage output	—	2–1,000
current output	Ω —	<500
Resolution	2.5 mV (12 bit)/8 μA (11 bit)	2.5 mV (12 bit)/8 μA (11 bit)
Fullscale overall accuracy	±1 %	±1 %
Conversion speed		
analog → digital	180 μs (1 program cycle)	—
digital → analog	—	60 μs (1 program cycle)
Related I/O points	0	0
Weight	kg	0.02
Dimensions (WxHxD)	mm	35x51.2x29.2
<b>Order information</b>	Art. no.	
	221265	221266



**Analog setpoint adapter board**  FX3S  FX3G  FX3GC  FX3GE  FX3U  FX3UC

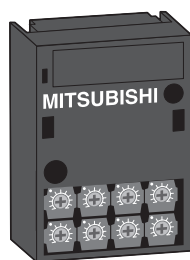

Connector side

**Analog setpoint adapter FX3G-8AV-BD**

The FX3G-8AV-BD analog setpoint adapter enables the user to set 8 analog setpoint values. The analog values of the potentiometers are read into the controller and used as default setpoint values for timers, counters and data registers by the user's PLC programs.

Setpoint value polling and the definition of the potentiometer scales are performed in the PLC program using the dedicated instructions VRRD/VRSC (FNC85/86).

The analog setpoint adapter is installed in the expansion slot of the FX3S/FX3G resp. FX3GE CPU. No additional power supply is required for operation.

Specifications		FX3G-8AV-BD
Applicable for		Base units FX3S/FX3G/FX3GE
Power supply		From base unit
Adjusting range		8 Bit
Related I/O points		0
Potentiometer evaluation		Via application instruction from the PLC CPU (FNC 85/86)
Weight	kg	0.02
Dimensions (WxHxD)	mm	35x51.2x12
<b>Order information</b>		Art. no. 221267

**Communications adapter board**  FX3S  FX3G  FX3GC  FX3GE  FX3U  FX3UC

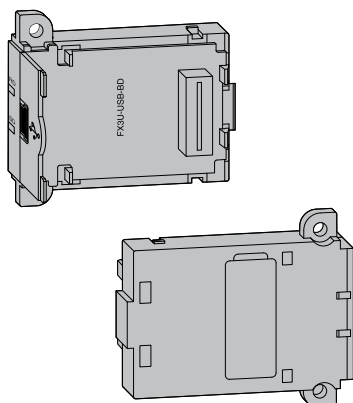

**Adapter board FX3U-USB-BD**

This adapter board allows direct USB 2.0 connection to the front of the FX3U PLC for program maintenance.

Specifications		FX3U-USB-BD
Applicable for		Base units FX3U
Power supply		5 V DC (from base unit)
Weight	kg	0.02
Dimensions (WxHxD)	mm	19.6x46.1x53.5
<b>Order information</b>		Art. no. 165284

**Expansion adapters**  FX3S  FX3G  FX3GC  FX3GE  FX3U  FX3UC

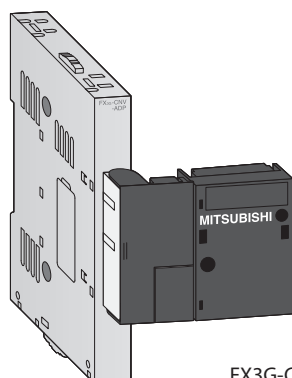

FX3G-CNV-ADP

**Expansion adapters FX3G-CNV-ADP, FX3S-CNV-ADP, FX3U-CNV-BD**

The below listed expansion adapters enable the connection of the adapter modules

FX□□-□□□ADP on the left hand side of the FX3S, FX3G and FX3U base units.

Specifications		FX3G-CNV-ADP	FX3S-CNV-ADP	FX3U-CNV-BD
Applicable for		Base units FX3G	Base units FX3S	Base units FX3U
Weight	kg	0.1	0.1	0.01
Dimensions (WxHxD)	mm	90x14.6x86	90x14.6x74	19.6x46.1x53.5
<b>Order information</b>		Art. no. 221268	267132	165285

Interface adapters

FX3S  FX3G  FX3GC  FX3GE  FX3U  FX3UC

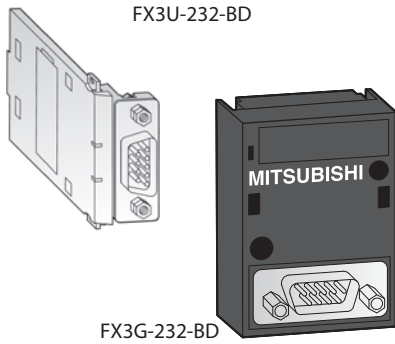

Interface adapters FX3G-232-BD, FX3U-232-BD

The FX□□-232-BD interface adapters provide an RS232C interface for serial data communications with the MELSEC FX3S, FX3G, FX3GE or FX3U.

Specifications	FX3G-232-BD	FX3U-232-BD
Applicable for	Base units FX3S/FX3G/FX3GE	Base units FX3U
Interface	RS232C with 9 pole D-SUB connector	
Power supply	5 V DC/20 mA (from base unit)	
Related I/O points	—	
Weight	kg 0.02	0.02
Dimensions (WxHxD)	mm 35x51.2x17.2	19.3x46.1x62.7
<b>Order information</b>	Art. no. 221254	165281

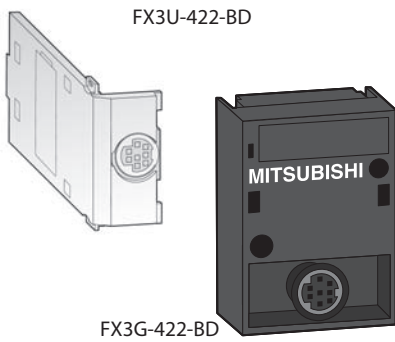

Interface adapters FX3G-422-BD, FX3U-422-BD

The interface adapter FX□□-422-BD expand a MELSEC FX3S, FX3G, FX3GE or FX3U PLC to a second RS422 interface for connection of additional devices such as programming devices or HMIs.

Specifications	FX3G-422-BD	FX3U-422-BD
Applicable for	Base units FX3S/FX3G/FX3GE	Base units FX3U
Interface	RS422 with 8 pole mini DIN connector	
Power supply	5 V DC/20 mA (from base unit)	
Related I/O points	—	
Weight	kg 0.02	0.02
Dimensions (WxHxD)	mm 35x51.2x14.9	19.6x46.1x53.5
<b>Order information</b>	Art. no. 221252	165282

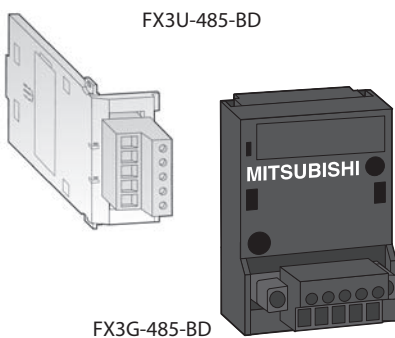

Interface adapters FX3G-485-BD, FX3U-485-BD

The interface adapters FX□□-485-BD provide the controller with an additional RS485 interface. The adapter, which is simply inserted into the base unit's expansion slot, enables the

configuration of RS485 1:n multidrop, parallel link or peer-to-peer networks with FX3S, FX3G, FX3GE or FX3U systems.

Specifications	FX3G-485-BD	FX3G-485-BD-RJ	FX3U-485-BD
Applicable for	Base units FX3S/FX3G/FX3GE		Base units FX3U
Interface	RS485/RS422		
Power supply	5 V DC/20 mA (from base unit)		5 V DC/40 mA (from base unit)
Related I/O points	—		
Weight	kg 0.02		0.02
Dimensions (WxHxD)	mm 35x51.2x29.2	35x51.2x22	19.6x46.1x69
<b>Order information</b>	Art. no. 221253	271699	165283

## Expansion adapter

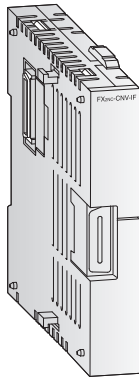
 FX3S  FX3G  FX3GC  FX3GE  FX3U  FX3UC

FX2NC-CNV-IF

### FX2NC-CNV-IF

The FX2NC-CNV-IF expansion adapter connects FX3UC main units with the standard FX0N/FX2N/FX3U right side expansion bus.

Specifications	FX2NC-CNV-IF	
Bus connection	FX3UC bus to FX0N/FX2N/FX3U bus	
Weight	kg	0.5
Dimensions (WxHxD)	mm	14.6x90x74
<b>Order information</b>	Art. no.	104508

## Memory media

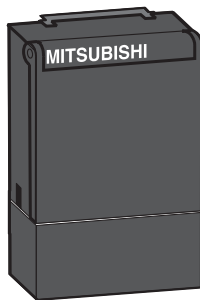
 FX3S  FX3G  FX3GC  FX3GE  FX3U  FX3UC

FX3G-EEPROM-32L

### Memory cassette for FX3S and FX3G/E/C

All FX3S, FX3G, FX3GC and FX3GE base units are equipped with a slot for the optional, robust memory cassette. By connection of this memory cassette, the internal memory of the controller is switched off and only the program specified in the respective memory cassette is run.

The memory cassette can upload/download programs to and from the FX PLC internal memory with the help of 2 buttons.

The memory cassette FX3G EEPROM 32L can also be mounted on an already installed BD interface or expansion adapter.

Specifications	FX3G-EEPROM-32L	
Applicable for	Base units FX3G/FX3S	
Memory type	EEPROM	
Size	32,000 steps (4,000 steps for FX3S)	
Protect switch	Provided	
Data transfer buttons	Provided	
<b>Order information</b>	Art. no.	221269

## Memory media

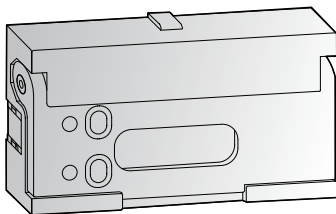
 FX3S  FX3G  FX3GC  FX3GE  FX3U  FX3UC

### Memory cassettes for FX3U/FX3UC

The memory cassette can be installed at the main unit, and when installed, the memory cassette's internal program is used in place of the internal RAM memory.

The FX3U-FLROM-64L features additional data transfer buttons.

Specifications	FX3U-FLROM-16	FX3U-FLROM-64	FX3U-FLROM-64L
Applicable for	Base units FX3U/FX3UC	Base units FX3U/FX3UC	Base units FX3U/FX3UC
Size	16,000 steps	64,000 steps	64,000 steps
Memory type	Flash memory	Flash memory	Flash memory
Protect switch	Provided	Provided	Provided
Data transfer buttons	—	—	Provided
Dimensions (WxHxD)	mm	37x20x6.1	37x20x6.1
<b>Order information</b>	Art. no.	165278	165279
			165280

■ Terminal blocks

□ FX3S □ FX3G □ FX3GC □ FX3GE  FX3U  FX3UC

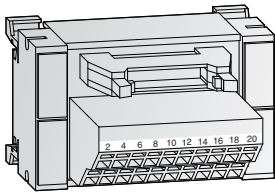

TB-20C

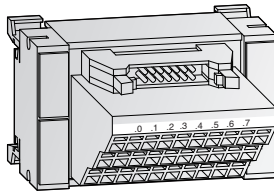

TB-□EX□

These terminal blocks are adapter modules that simplify the wiring of the inputs and outputs of the FX3UC main units with ribbon cable connectors. This practical, time-saving wiring system also improves the performance of the outputs. Special terminal blocks are also available for the FX3U/FX3UC positioning modules with ribbon cable connectors.

Input blocks, output blocks and combined I/O blocks are available, with a choice of different terminal types.

The TB-□EX□ input blocks are fitted with rows of bridged connectors for 24 V/0 V terminals, which make wiring quick and easy.

The TB-8EY-S and TB-8EY-C output blocks consist of 8 standard terminals and a system adapter. The standard terminals can be populated with relay or transistor elements, which makes it possible to configure the system for much higher output currents.

Preconfigured system cabling is available for all the terminal blocks (see next page).

Specifications	TB-8EX-S	TB-8EX-C	TB-16EX-S	TB-16EX-C
Type	Input block	Input block	Input block	Input block
Integrated inputs	8	8	16	16
Design	Initiator module with potential terminals			
Connection type	Screw terminals	Spring terminals	Screw terminals	Spring terminals
Application	FX2NC series base and extension modules with connectors			
Dimensions (WxHxD)	mm 75x45x54	75x45x63	116x45x54	116x45x63
<b>Order information</b>	Art. no. 149144	149145	149021	149022
<b>Accessories</b>	Connection Cable (see following page)			

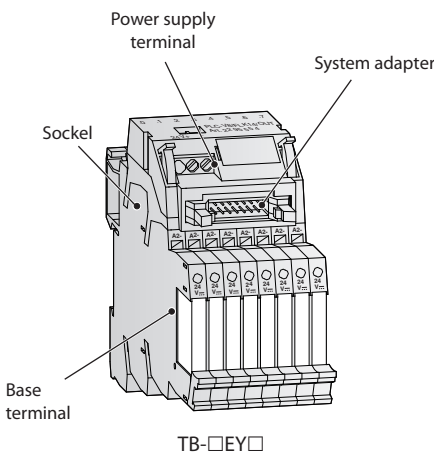

TB-□EY□

Specifications	TB-8EY-S	TB-8EY-C	TB-20-S	TB-20C
Type	Output block	Output block	Input/output block	Input/output block
Channels	8	8	8/16	8/16
Design	Socket for relay or transistor elements		20 pin terminal module	
Connection type	Screw terminals	Spring terminals	Screw terminals	Spring terminals
Application	FX2NC series base and extension modules with connectors		FX2N series positioning module	
Dimensions (WxHxD)	mm 49.6x100x94	49.6x100x94	75x45x52	75x45x52
<b>Order information</b>	Art. no. 149044	149045	149148	149023
<b>Accessories</b>	Pluggable function elements (see below), Connection cable (see following page)		Connection cable (see following page)	

The transistor and relay elements are plugged directly into the standard terminals in the TB-8EY-S or TB-8EY-C modules. All the elements feature a status LED, protection against reverse polarity connection and a freewheeling diode.

Neighbouring terminals with identical voltages can be connected with plug-in strip bridge connectors, which can be cut to length as required.

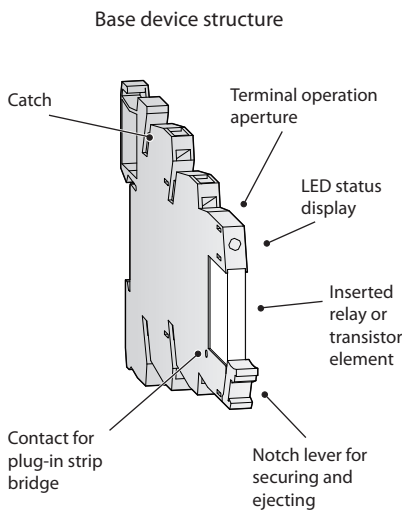

Specifications	TB-8RELAY-6A	TB-8TRANSISTOR-2A
Output type	Relay with 1 switch-over contact	Transistor (with optocoupler)
Number of elements	8	8
Rated input voltage	24 V DC	24 V DC
Switching voltage (min./max.)	12 V AC/DC; 250 V AC/DC	3 V DC; 33 V DC
Limit permanent current	6 A	3 A (at 20 °C), 2 A (at 60 °C)
Max. breaking capacity	140 W (24 V DC), 1500 VA (250 V AC)	—
Ambient temperature	-20—+60 °C	-20—+60 °C
<b>Order information</b>	Art. no. 149034 (set with 8 elements)	149035 (set with 8 elements)
<b>Accessories</b>	Insulated infinite pin bridge for potential isolation, TB-PIB-RD, color red, art.-no.: 149146; Insulated infinite pin bridge for potential isolation, TB-PIB-BC, color blue art.-no.: 149147; Isolation plate TB-SP for lateral base terminal connection, art.-no.: 149158	

## Terminal connection cable

FX3S  FX3G  FX3GC  FX3GE  FX3U  FX3UC

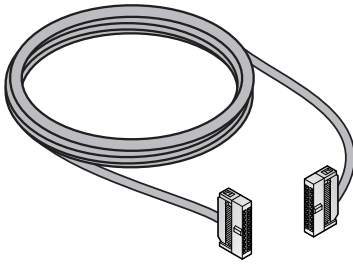

These preconfigured cables enable quick, error-free wiring of the terminal blocks of the positioning modules for the FX3U and FX3UC series fitted with ribbon cable connectors.

The cables are available in a choice of lengths between 1 and 5 m. Other lengths are also possible by special order.

Specifications	TB-EX-CAB-1M	TB-EX-CAB-3M	TB-EX-CAB-5M
Application	For TB-□EX□ and TB-20-□ (1:1 cable)		
Length	m 1	3	5
<b>Order information</b>	Art. no. 149038	149039	149040

Specifications	TB-EY-CAB-1M	TB-EY-CAB-3M	TB-EY-CAB-5M
Application	For 2 x terminal block TB-8EY-S or TB-8EY-C (Y cable)		
Length	m 1	3	5
<b>Order information</b>	Art. no. 149041	149042	149043

## Connection terminals

FX3S  FX3G  FX3GC  FX3GE  FX3U  FX3UC

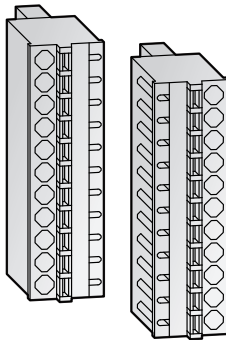

The base unit FX2NC-16MR-T-DS and the extension units FX2NC-16EX-T-DS and FX2NC-16EYR-T-DS are fitted with screw terminals as standard equipment.

These plug-in terminals can easily be replaced with spring terminals if required.

Two replacement terminal units are required for each module with 16 I/Os.

Specifications	TB-CON-5-C	TB-CON10-C
Number of terminal points	5	10
Connection type	Spring terminals	Spring terminals
Application	Adapter modules	Adapter modules and FX2NC-16EX-T-DS/ FX2NC-16EYR-T-DS extension modules
Dimensions (WxHxD)	mm 12.5x20x21	12.5x20x21
<b>Order information</b>	Art. no. 221539	149036

■ 24 V power supply unit

☑ ALPHA ☑ FX3S ☑ FX3G ☑ FX3GC ☑ FX3GE ☑ FX3U ☑ FX3UC

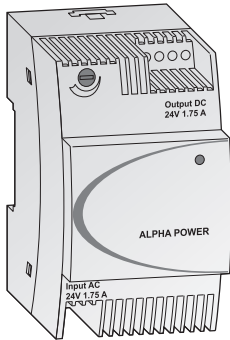

The ALPHA-POWER units are a convenient power supply for 24 V units and other external devices. They come with mounting system for wall or DIN rail mounting and their dimensions are matched to those of the ALPHA family.

Up to 5 power supply units can be installed together for redundant mode operation or connected in parallel for more power. The units have an integrated thermal overload protection circuit and a POWER LED. The output voltage is adjustable.

Specifications	ALPHA POWER 24-0.75	ALPHA POWER 24-1.75	ALPHA POWER 24-2.5
Application	Power supply for 24 V DC Alpha base units		
General specifications	Conforms to FX family and ALPHA base units		
Nominal input voltage	100–240 V (45–65 Hz)		
Output voltage	24 V DC (+/-1 %)		
Nominal output current	0.75 A (at T=55 °C)	1.75 A (at T=55 °C)	2.5 A (at T=55 °C)
Max. output current	1.4 A	3.75 A	4.4 A
Ambient temperature	-25–+55 °C (operation), -40–+85 °C (storage)		
Ambient humidity	max. 95 % (no condensation)		
Weight	kg 0.1	0.2	0.3
Dimensions (WxHxD)	mm 36x90x61	54x90x61	72x90x61
Order information	Art. no. 209029	209030	209031

■ 5 V power supply unit

☐ FX3S ☑ FX3G ☑ FX3GC ☑ FX3GE ☑ FX3U ☑ FX3UC

5 Accessories

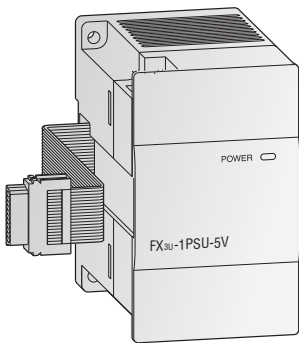

FX3U-1PSU-5V

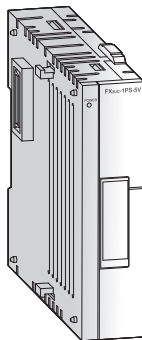

FX3UC-1PS-5V

The power supply modules FX3U-1PSU-5V and FX3UC-1PS-5V are used to reinforce the build-in 5 V DC and 24 V DC power supply of a FX3G/FX3GC/FX3GE/FX3U/FX3UC main unit.

They do not occupy any I/O points and deliver up to 1 A more current for the 5 V system bus (for special function modules).

Up to two FX3U-1PSU-5V or FX3UC-1PS-5V modules can be used.

Both modules have an integrated overload protection available.

Specifications	FX3U-1PSU-5V	FX3UC-1PS-5V
Application	Power supply for the FX3G/FX3U system bus	Power supply for the FX3G/FX3GC/FX3UC system bus
General specifications	Conforms to FX family base units	
Nominal input voltage	100–240 V (50/60 Hz)	
Output voltage	5 V DC/24 V DC	24 V DC (+20 %/-15 %)
Max. output current	5 V DC 1 A at 40 °C; 0.8 A at 55 °C 24 V DC 0.3 A at 40 °C; 0.2 A at 55 °C	5 V DC 1 A
Ambient temperature	-25–+55 °C (operation), -40–+85 °C (storage)	
Ambient humidity	max. 95 % (no condensation)	
Weight	kg 0.3	0.15
Dimensions (WxHxD)	mm 55x90x87	24x90x74
Order information	Art. no. 169507	210086

Note:

The FX3U-1PSU-5V can't be used with a 24 V base unit!

When connecting an input extension module (incl. FX2N-8ER-ES/UL, FX2N-8ER) to the FX3U-1PSU-5V, supply the power for it from the 24 V DC service power supply of the connected main unit or powered extension unit on the upstream side.

■ Backup batteries

☐ FX3S ☑ FX3G ☑ FX3GC ☑ FX3GE ☑ FX3U ☑ FX3UC

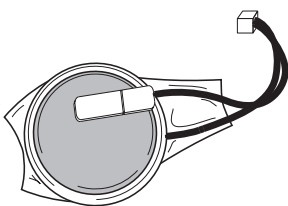

FX3U-32BL

**Batteries**

The battery buffers the internal RAM of the MELSEC PLC in the event of a voltage failure.

The battery FX3U-32BL can be used for all base units of the MELSEC FX3G/FX3GC/FX3GE/FX3U/FX3UC series.

Specifications	FX2NC-32BL	FX3U-32BL
Applicable for	FX2N-20GM-Modul	Base units FX3G/FX3GC/FX3GE/FX3U/FX3UC
Order information	Art. no. 128725	165286

**Cables**

ALPHA  FX3S  FX3G  FX3GC  FX3GE  FX3U  FX3UC

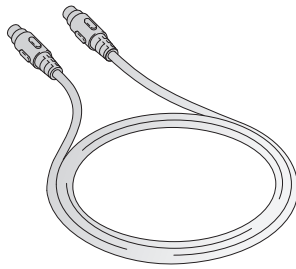

FX-20P-CAB0

**FX Series connection cables**

The cable listed in the following tables are used for FX Series PLC programming, positioning

applications, block connections and interface conversion.

**Connection cable for RS232C peripherals**

Specifications	F2-RS-5CAB	F2-232CAB-1	FX-232CAB-1
Applicable for	FX2N-1RM to resolver	PC to FX-232AWC-H	PC to GOT
Length	m 5.0	3.0	3.0
<b>Order information</b>	Art. no. 76160	76163	124972

**Connection cable for RS422 peripherals**

Specifications	FX-422CAB0	FX-422CAB	FX-422CAB-150
Application	FX-232AWC-H to FX□ PLC	FX-232AWC-H to FX PLC	FX-232AWC-H to FX PLC
Length	m 1.5	0.3	1.5
<b>Order information</b>	Art. no. 76094	25949	—

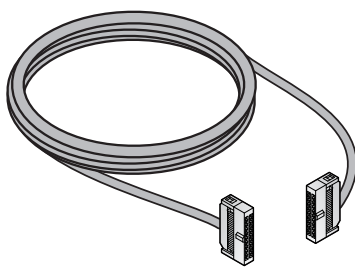

FX-16E-500CAB

**Connection cable for programming unit**

Specifications	FX-20P-CAB0	FX-20P-CAB	FX-20P-CADP
Application	FX-20P-G/FX-30P to FX□ PLC	FX-20P-E to FX PLC	FX-20P-CAB to FX□ PLC
Length	m 1.5	1.5	0.3
<b>Order information</b>	Art. no. 55917	30815	31870

**Connection cable for extension bus**

Specifications	FX0N-65EC	FX2N-CNV-BC
Application	PLC bus cable for two-stage-configuration with extension units FX□□□-□□□ES	Adapter for the connection of the FX0N-65EC to special function modules FX3U/FX2N
Length	m 0.65	
<b>Order information</b>	Art. no. 45348	70880

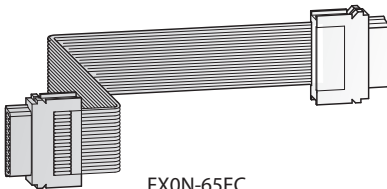

FX0N-65EC

**Interface converter**

Specifications	FX-USB-AW	FX-232AWC-H
Application	USB to RS422 converter	RS422 to RS232C converter
Dimensions (WxHxD)	mm 62x21x15	80x60x25
<b>Order information</b>	Art. no. 165288	159642

**Programming cables**

FX3S  FX3G  FX3GC  FX3GE  FX3U  FX3UC

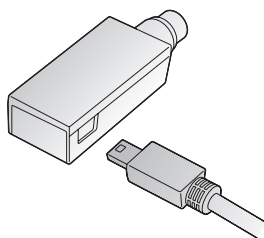

FX-USB-AW

The USB to RS-422 converter FX-USB-AW is used for the connection between the PLC and a serial interface of a personal computer. The converter is divided into 2 parts and thus universally applicable for all FX-series PLCs.

The SC-09 programming cable is used for the connection between the PLC and a serial interface of a personal computer. The cable is divided into 2 parts and thus universally applicable for all Mitsubishi Electric PLCs.

	FX-USB-AW	SC-09
Connection on PC side	USB	9-pin D-SUB
<b>Order information</b>	Art. no. 165288	43393

■ Display modules

FX3S  FX3G  FX3GC  FX3GE  FX3U  FX3UC

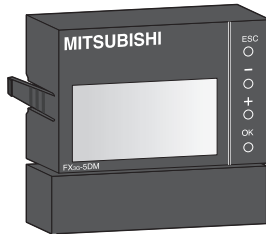
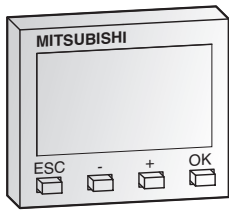

**Display module FX3G-5DM**

The display module FX3G-5DM is inserted directly with space-saving into the controller and enables monitoring and editing of the data stored in the PLC.

The display module e.g. can be used instead of digital switches and external 7-segment displays in very confined areas.

Specifications	FX3G-5DM
Applicable for	Base units FX3G/FX3GE
Display	LCD (with backlight)
Power supply	5 V DC ±5 % (from base unit)
Current consumption	mA n/a
Dimensions (WxHxD)	mm 49x34x12
<b>Order information</b>	Art. no. 221270

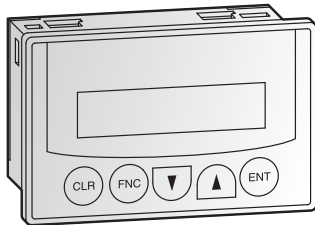

**Control and display panel FX-10DM-E**

The control and display panel FX-10-DM-E provides a key-oriented user-interface and enables you to monitor and edit process data in the PLC.

The connection with the PLC is possible via the cable FX-20P CAB0.

The display is arranged in 2 rows of 16 characters each. Functions can be invoked and values can be edited using the panel keys.

Specifications	FX-10DM-E
Applicable for	All base units FX3U
Display	LCD (with backlight)
Resolution	2x16 signs (80x16 pixels)
Power supply	5 V DC ±5 % (from base unit)
Current consumption	mA 220
Weight	kg 0.02
Dimensions (WxHxD)	mm 96x62x32
<b>Order information</b>	Art. no. 132600

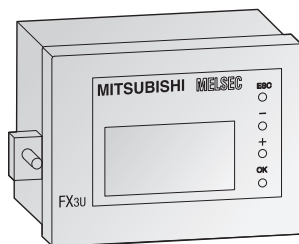

Panel FX3U-7DM with built-in holder FX3U-7DM-HLD

**Control and display panel FX3U-7DM, holder FX3U-7DM-HLD**

The FX3U-7DM display module can be incorporated in the main unit, or can be installed in

the enclosure using the FX3U-7DM-HLD display module holder.

Specifications	FX3U-7DM	FX3U-7DM-HLD
Applicable for	Base units FX3U	Base units FX3U
Display	16 letters x 4 lines	—
Resolution	—	—
Power supply	5 V DC (from base unit)	—
Current consumption	mA 20	—
Extension cable	—	Included
Weight	kg 0.02	0.01
Dimensions (WxHxD)	mm 48x35x11.5	66.3x41.8x13
<b>Order information</b>	Art. no. 165268	165287

Please refer to the HMI family catalogue for further operator terminals



### Dimensions of the ALPHA series

AL2-14M□-□, AL2-24M□-□

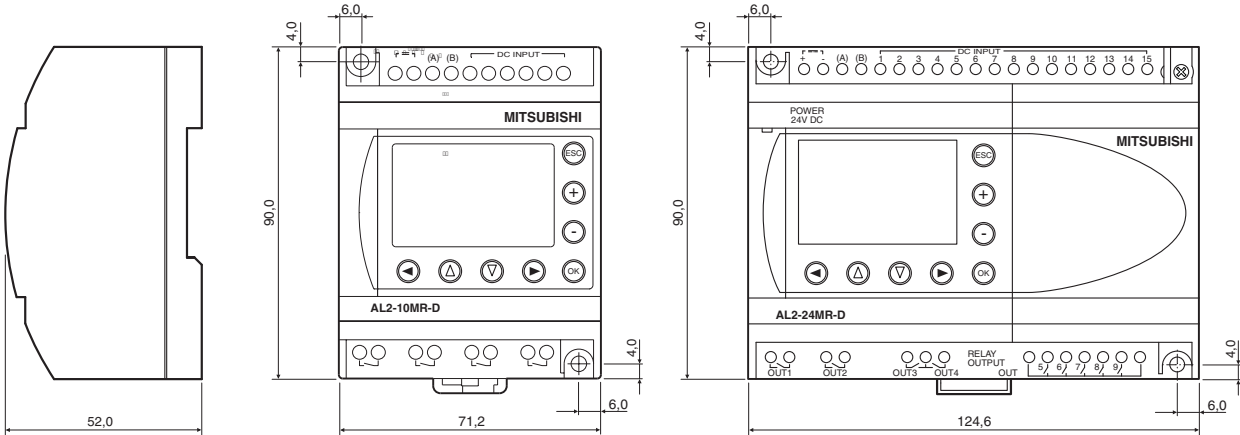

AL2-4EY□, AL2-2DA

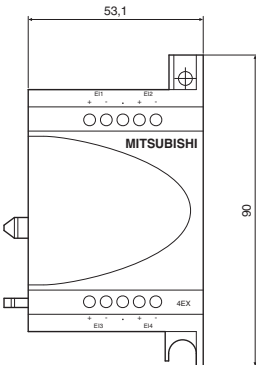

AL2-ASI-BD

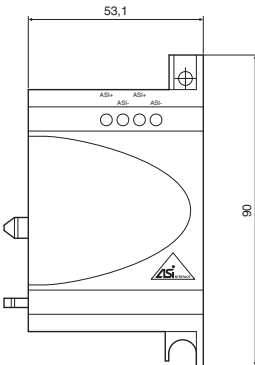

AL2-2PT-ADP, AL2-2TC-ADP

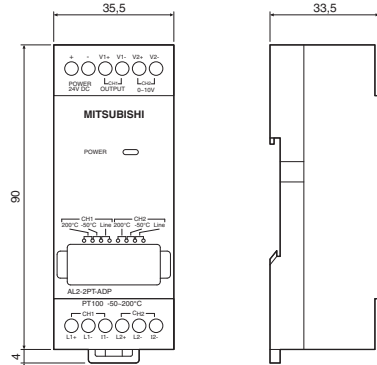

All dimensions in mm

### Dimensions of base units FX3S

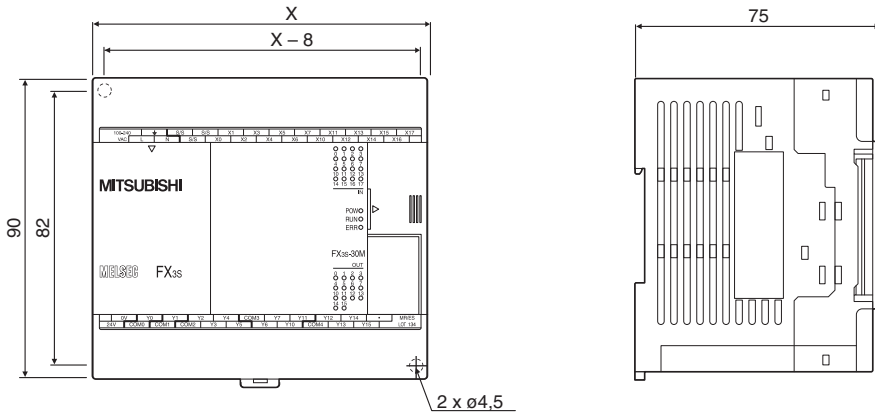

Base units	X
FX3S-10MR-ES	60
FX3S-10MT-ESS	60
FX3S-14MR-ES	60
FX3S-14MT-ESS	60
FX3S-20MR-ES	75
FX3S-20MT-ESS	75
FX3S-30MR-ES	100
FX3S-30MT-ESS	100

All dimensions in mm

### Dimensions of base units FX3G

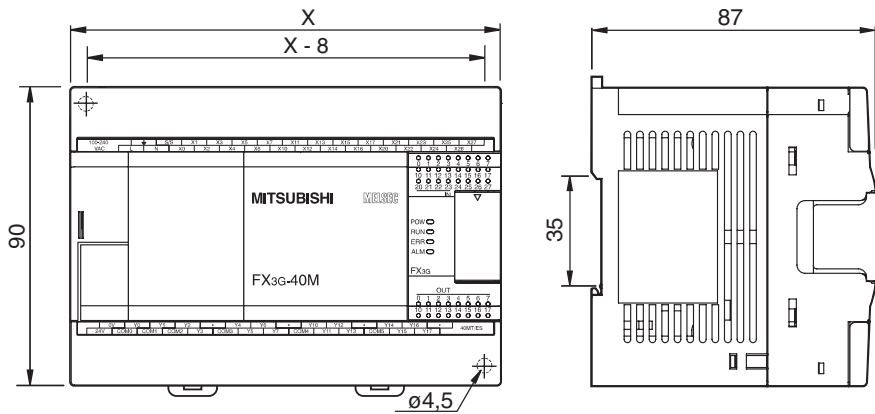

Base units	X
FX3G-14	90
FX3G-24	90
FX3G-40	130
FX3G-60	175

All dimensions in mm

### Dimensions of base units FX3GE

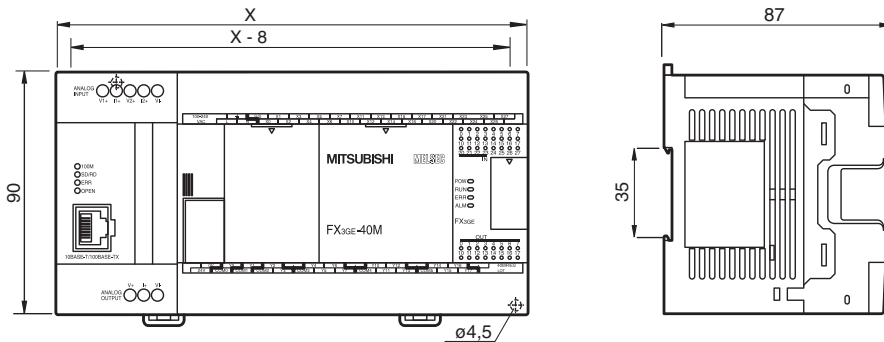

Base units	X
FX3GE-24	130
FX3GE-40	175

All dimensions in mm

### Dimensions of base units FX3GC

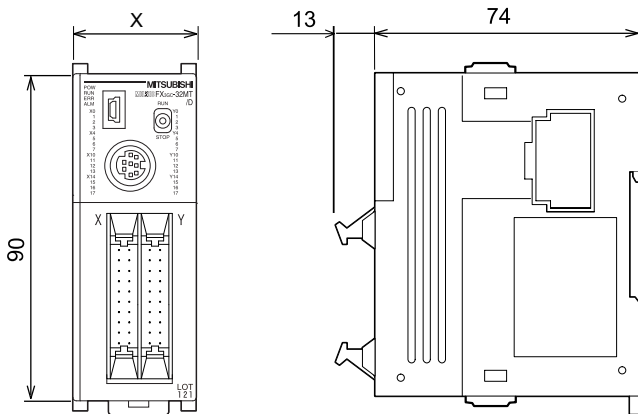

Base units	X
FX3GC-32MT/DSS	35

All dimensions in mm

### Dimensions of base units FX3U

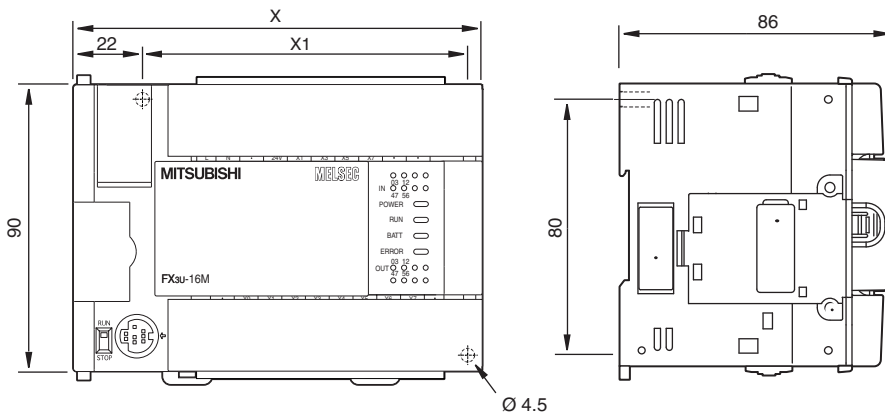

Base units	X	X1
FX3U-16M□□□	130	103
FX3U-32M□□□	150	123
FX3U-48M□□□	182	155
FX3U-64M□□□	220	193
FX3U-80M□□□	285	258
FX3U-128M□□□	350	323

All dimensions in mm

### Dimensions of base units FX3UC

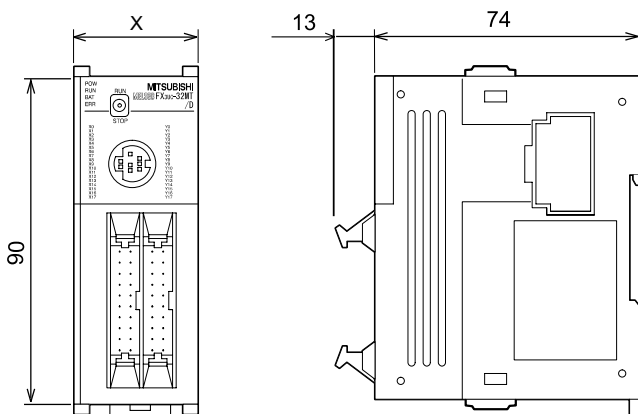

Base units	X
FX3UC-16MT/DSS	34
FX3UC-32MT/DSS	34
FX3UC-64MT/DSS	59.7
FX3UC-96MT/DSS	85.4

All dimensions in mm

### Dimensions of adapter modules FX3U and extension adapters

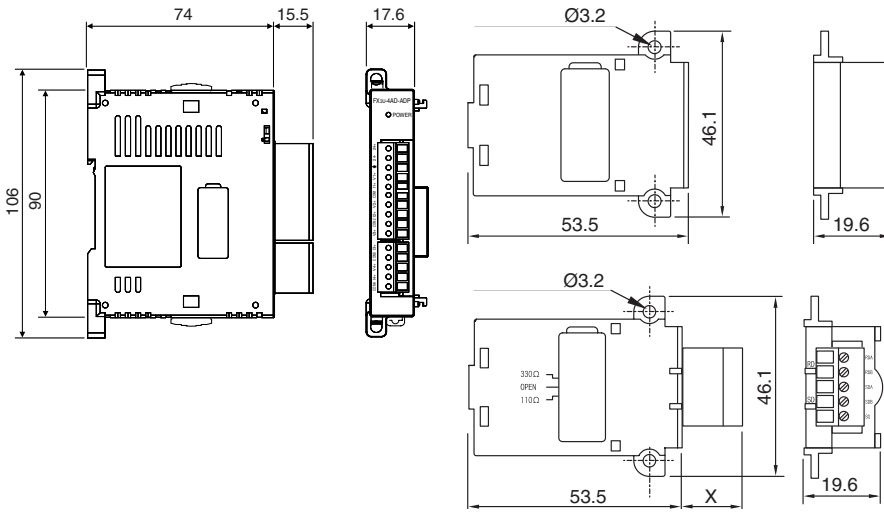

#### Extension adapters

Type	X
FX3U-CNV	—
FX3U-USB	—
FX3U-485	15.5
FX3U-422	—
FX3U-232	9.2

All dimensions in mm

### Dimensions of compact extension units and modular extension blocks MELSEC FX2N

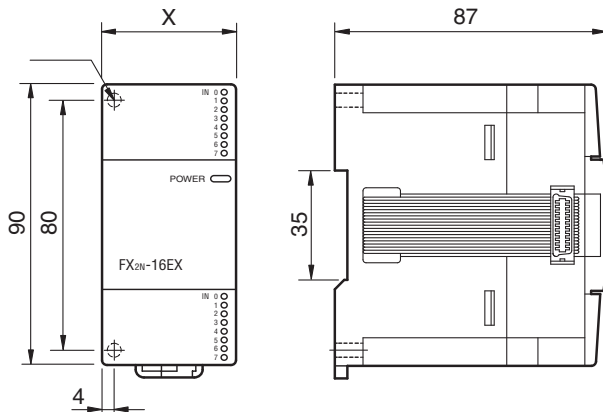

#### Compact extension units

Type	X
FX2N-32E□□□	150
FX2N-48E□□□	182
FX2N-48ER-UA1/UL	220

#### Modular extension blocks

Type	X
FX2N-8E□□□	43
FX2N-16E□□□	40

All dimensions in mm

### Dimensions of modular extension blocks FX2NC

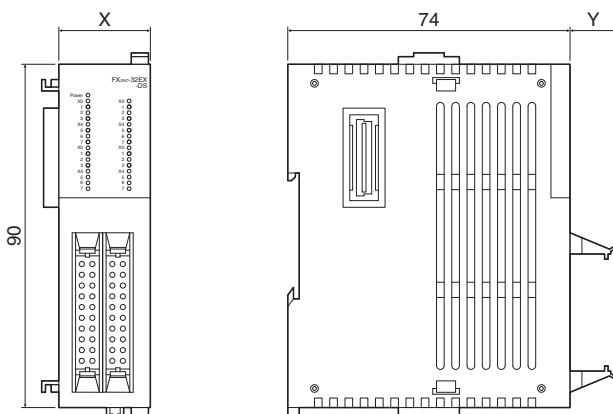

#### Extension blocks

Type	X	Y
FX2NC-16EX-DS	14.6	13
FX2NC-16EYT-DSS	14.6	13
FX2NC-16EX-T-DS	20.2	15
FX2NC-16EYR-T-DSS	24.2	15
FX2NC-32EX-DS	26.2	13
FX2NC-32EYT-DSS	26.2	13

All dimensions in mm

### Dimensions of special function modules MELSEC FX2N

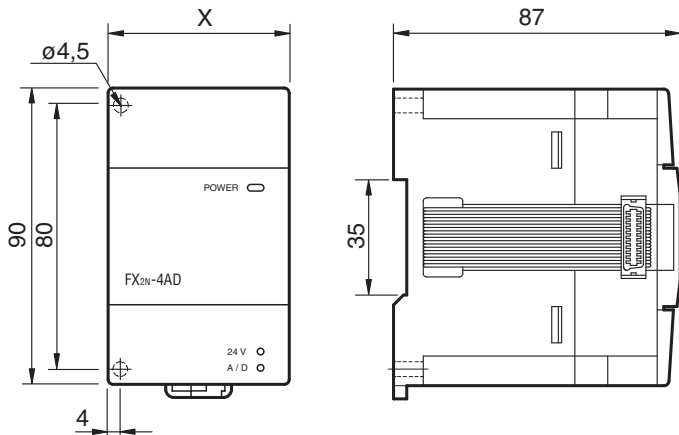

#### Special function modules FX0N/FX2N

Type	X
FX0N-3A	43
FX2N-2DA	43
FX2N-2AD	43
FX2N-4DA	55
FX2N-4AD	55
FX2N-4AD-TC	55
FX2N-4AD-PT	55
FX2N-1HC	55
FX2N-10PG	43
FX2N-2LC	55
FX2N-5A	55
FX2N-232-IF	55
FX2N-64DNET	43

FX2N-8AD

FX2N-32DP-IF

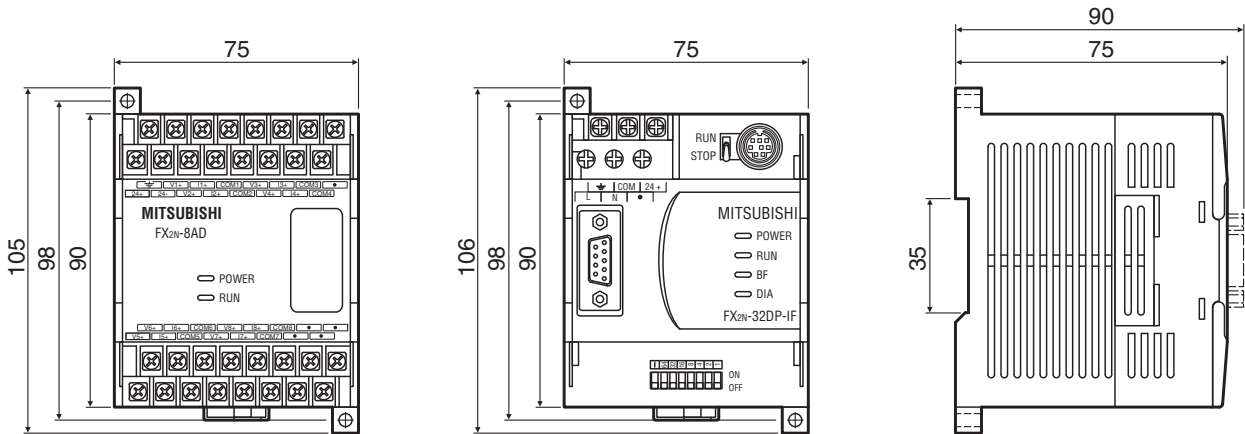

All dimensions in mm

### Dimensions of special function modules MELSEC FX3U/FX3UC

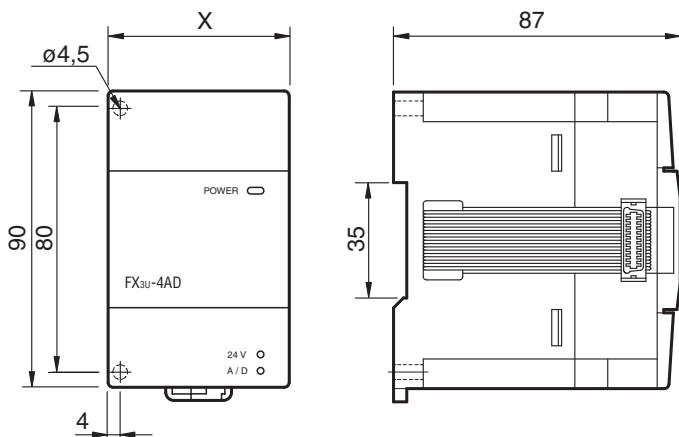

#### Special function modules FX3U/FX3UC

Type	X
FX3U-2HC	55
FX3U-3A-ADP	17.6
FX3U-4DA	55
FX3U-4AD	55
FX3U-4LC	90
FX3U-CF-ADP	45
FX3U-ENET	55
FX3U-CAN	43
FX3U-20SSC-H	55
FX3U-64CCL-M	55
FX3U-64DP-M	43
FX3U-1PSU-5V	55
FX3UC-4AD	20.2
FX3UC-1PS-5V	24.2
FX3U-1PG	43
FX3U-J1939	43

All dimensions in mm

## Dimensions of adapters FX3G

FX3G-485-BD

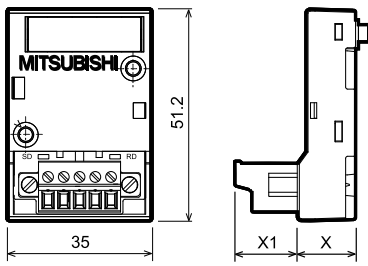

### FX3G extension adapters

Type	X	X1
FX3G-1DA-BD	14.1	15.1
FX3G-232-BD	12	5.2
FX3G-2AD-BD	14.1	15.1
FX3G-422-BD	12	2.9
FX3G-485-BD	14.1	15.1
FX3G-8AV-BD	12	—

All dimensions in mm

## Dimensions for terminal blocks

TB-20-S

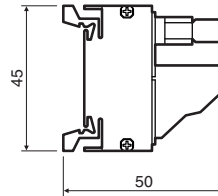
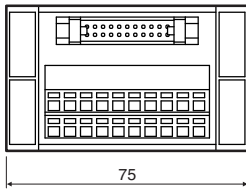

TB-20-C

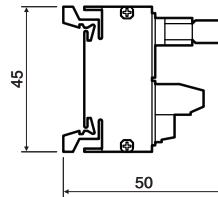
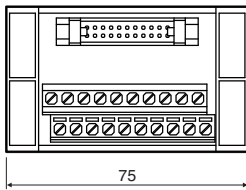

TB-8EX-S

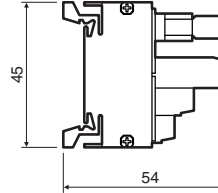
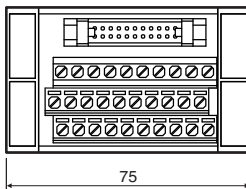

TB-8EX-C

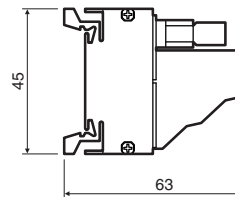
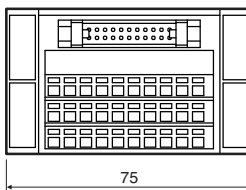

TB-16EX-S

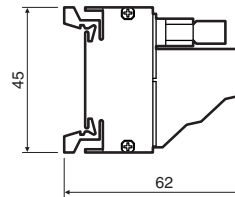
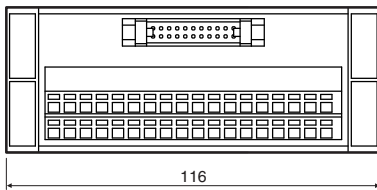

TB-16EX-C

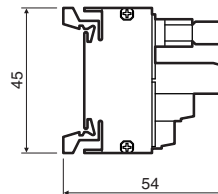
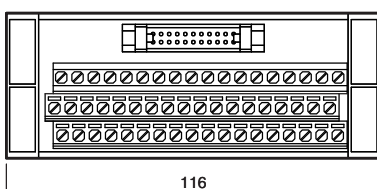

## Dimensions of the memory cassettes

FX3G-EEPROM-32L

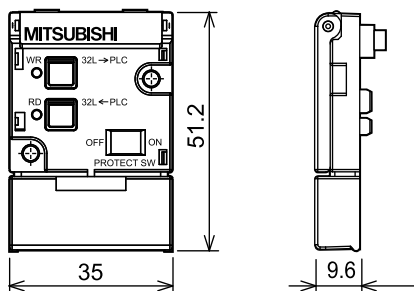

FX3U-FLROM-16/64/64L

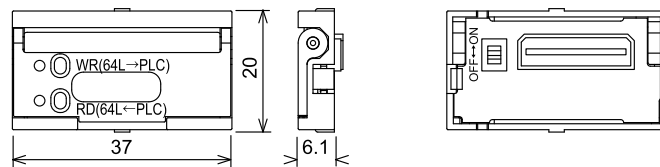

All dimensions in mm

## Dimensions for display panels

FX3U-7DM

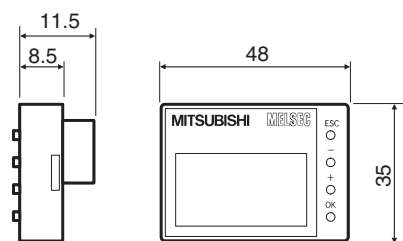

FX3G-5DM

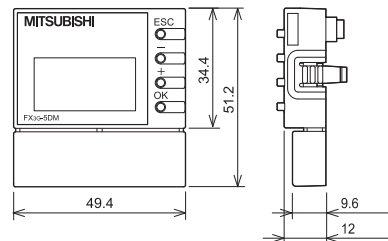

FX-10DM-E

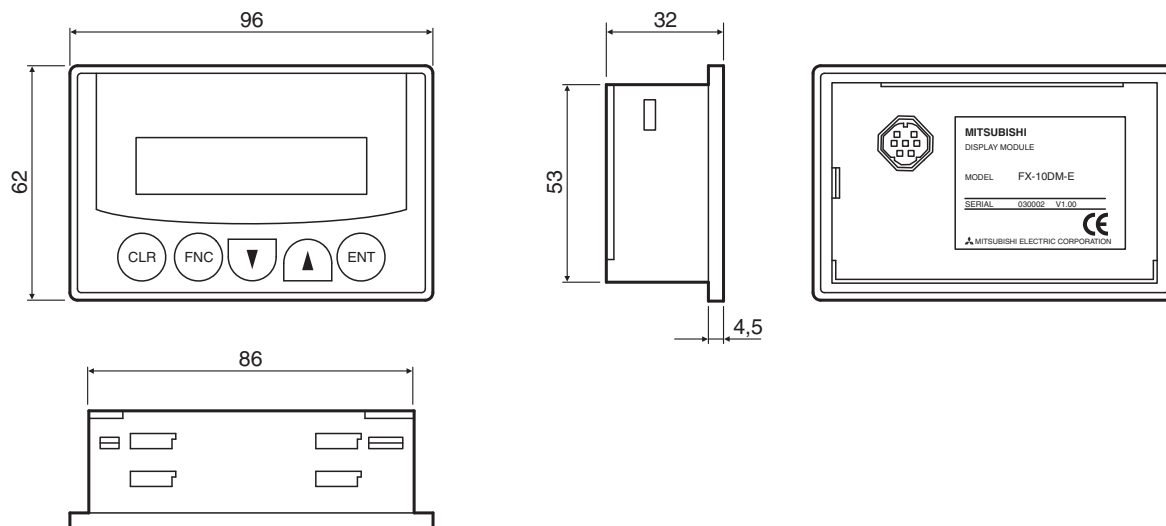

All dimensions in mm

## MELSOFT – programming and documentation software for standard personal computers



With the MELSOFT software family Mitsubishi Electric offers efficient software packages helping to reduce programming and setup times to a high degree. The MELSOFT software family provides instant access, direct communications, compatibility, and open exchange of variables.

The MELSOFT family comprises:

- Programming packages AL-PCS/WIN and GX Works2/GX Works2 FX
- Various development software for operator terminals (please refer to the technical catalogue HMI)
- Software for a dynamic data exchange like MX Change

AL-PCS/WIN is recommended as a cost-effective beginners package for the ALPHA series. This package offers a quick and easy introduction to programming.

GX Works2 is the right decision for a universal programming package. In addition to the FX family, the MELSEC L series and the MELSEC System Q can be programmed.

For detailed information please order our separate MELSOFT brochure.

### ■ ALPHA programming software

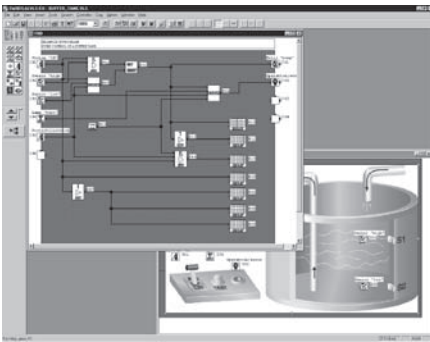

#### AL-PCS/WIN programming software

All controllers of the ALPHA series can be programmed with the MS Windows® software AL-PCS/WIN. Programming the ALPHA with this software is very easy and is done by placing the different program elements on a graphical programming environment. The connections (wiring) between the inputs, function blocks, and outputs are drawn graphically by mouse

click to build the logic. By this, programs with up to 200 function blocks can be created, where each single function in a program can be used as many times as desired.

A complete documentation of the program can be created directly from AL-PCS/WIN.

Software (AL-PCS/WIN)	
Series	Alpha series
Language	7 languages (English/German/French/Italian/Spanish/Swedish/Russian)
Einsetzbar bei	Windows 95/98/ME/NT/2000/XP/Vista/7
<b>Order information</b>	Art. no. 215028

Note:  
The AL-PCS/WIN software can be downloaded free of charge



## PLC programming software

### ■ GX Works2/GX Works2 FX

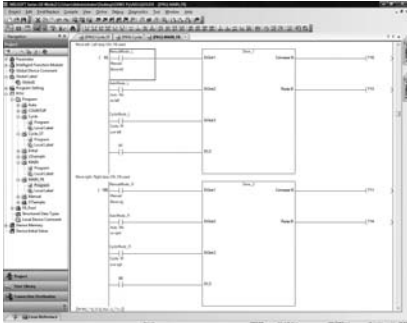

GX Works2 is the PLC programming environment of the next generation. It supports all PLC of the MELSEC System Q, L and FX series and offers numerous functions to facilitate programming work and support the user. GX Works2 FX has the same functionality as GX Works2 but just for FX PLC's.

The following programming languages are available:

- ST (Structured Text)
- SFC (Sequential Function Chart)
- LD (Ladder Diagram)
- FBD (Function Block Diagram)
- IL (Instruction List) – planned capability

The main features of GX Works2 are:

- Integrated parameterization of special function modules (analog, temperature, positioning, counter, network)
- Use of program and function block libraries save time for programming and minimizes errors.
- Integrated simulation allows offline testing of the software and the configuration.
- Comprehensive diagnostics and debugging functions support the user in troubleshooting and fault clearance.
- Revision verification and restoration makes it possible to restore old program versions or to compare with programs from the PLC.
- GX Works2 is compatible with GX Developer and GX IEC Developer projects (as far as the editors are supported)

Software	Series	Language	Disk type	Art. no.
GX Works2 FX V01-2LOC-E	FX3S, FX3G, FX3GC, FX3GE, FX3U, FX3UC	English	DVD	255804
GX Works2 FX V01-2LOC-E-INTRODUCTION				256745
GX Works2 V01-2LOC-E	All MELSEC PLCs	English	DVD	234630
GX Works2 V01-5LOC-E				234631
GX Works2 V01-2LOC-E-UPGRADE				234632
GX Works2 V01-5LOC-E-UPGRADE				234634
GX Works2 V01-2LOC-E-INTRODUCTION				234789
GX Works2 V01-2LOC-G	All MELSEC PLCs	German	DVD	244876
GX Works2 V01-5LOC-G				244877
GX Works2 V01-2LOC-G-INTRODUCTION				244878
Accessory	Programming cable SC-09			43393

## Software for Profibus networks

### ■ GX Configurator DP



The GX Configurator DP is a user friendly configurations software for the open network Profibus DP.

The software package is a 32 bit application and runs under all Windows versions.

Configuration of all Profibus DP modules for the MELSEC Ans/QnAS and A/Q series and also the FX family is possible.

Due to the supported extended user parameters of a GSD file, easy parameter setting of Profibus DP slave devices is possible even for third-party devices.

The new GX Configurator DP enables the download of all configuration data via an overriding network.

All Profibus modules are configured via the backside bus.

Software		GX Configurator DP V07-1LOC-M
Supported Profibus DP master modules for the Mitsubishi Electric MELSEC series		A1SJ71PB92D, AJ71PB92D, QJ71PB92D
Language		English/German
Disk type		CD ROM
<b>Order information</b>	Art. no.	231731
<b>Accessory</b>		Programming cable SC-09, art. no.: 43393

### ■ FX Configurator FP

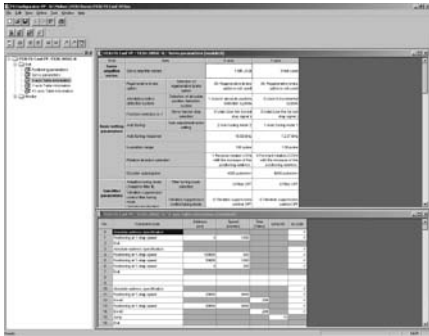

FX Configurator-FP is beneficial for setting up table operation information, servo amplifier parameters and positioning parameters for the FX3U-SSC-H positioning module. Positioning operations and their associated parameters (speeds, addresses, torque limits etc.) can be monitored and tested with the integrated monitor and test functions.

Control patterns from simple to complicated combinations of positioning commands can easily be configured with new methods.

The software runs under all Windows® versions.

Software		FX Configurator FP V0100-1LOC-E
Supported modules for the Mitsubishi Electric MELSEC series		FX3U-20SSC-H
Language		English
Disk type		CD ROM
<b>Order information</b>	Art. no.	189283
<b>Accessory</b>		Programming cable SC-09, art. no.: 43393

## ■ Hand-held programming unit



### FX-30P programming unit

The FX-30P is a small, industrial programming and maintenance tool for the FX Series. This unit can perform program uploads/downloads and store up to 15 programs in its internal memory. Keywords can be registered, deleted or canceled in applicable PLCs. Program monitoring and data device adjustment functionality is also available. To stay up to date the latest firmware

can be downloaded on a PC then installed via the USB port. PLC programs on the PC can also be transferred via USB, eliminating the need for peripheral devices.

Note: FX-30P firmware and program downloads from a PC via the embedded USB port available in firmware versions 1.10 and later.

Specifications		FX-30P
Applicable for		Base units FX1S, FX1N, FX3G, FX2N, FX3U, FX3UC
Ambient temperature		0–40 °C
Ambient relative humidity (non-condensing)		5–95 %
Power supply		5 V DC $\pm$ 5 %/155 mA (from main unit)
Display		LCD (with backlight)
Character display		21x8
Keyboard		35
Memory	Program capacity	Built-in RAM: 64K steps for program monitoring and modification RAM retention (for about five years, ambient temperature 25 C (77 F)) by battery. Built-in flash memory ROM: Up to 15 programs can be stored in the built-in flash memory ROM. Allowable number of writes: 100,000 times
	HPP held data	Display language setting (Japanese, English or Chinese), contrast, buzzer sound volume, brightness adjustment, screen saver and HPP protect key (saved in the built-in flash memory)
Cable		FX-20P-CAB0
Weight	kg	0.3
Dimensions (WxHxD)	mm	87x170x30
<b>Order information</b>		Art. no. 221271

## Certifications

Module type	CE		UL cUL	Ship approvals					
	EMC	LVD*		ABS	DNV	LR	GL	BV	RINA
<b>ALPHA 2 base units</b>									
AL2-10MR-A	●	●	●	—	—	—	—	—	—
AL2-10MR-D	●	●	●	—	—	—	—	—	—
AL2-14MR-A	●	●	●	—	●	—	—	—	—
AL2-14MR-D	●	●	●	—	●	—	—	—	—
AL2-24MR-A	●	●	●	—	●	—	—	—	—
AL2-24MR-D	●	●	●	—	●	—	—	—	—
<b>ALPHA extension modules</b>									
AL2-4EX-A2	●	●	●	—	●	—	—	—	—
AL2-4EX	●	●	●	—	●	—	—	—	—
AL2-4EYR	●	●	●	—	●	—	—	—	—
AL2-4EYT	●	●	●	—	●	—	—	—	—
AL2-2DA	●	●	●	—	—	—	—	—	—
AL2-2PT-ADP	●	●	●	—	—	—	—	—	—
AL2-2TC-ADP	●	●	●	—	—	—	—	—	—
AL2-ASI-BD	●	●	●	—	●	—	—	—	—
<b>FX3S base units</b>									
FX3S-10MR-SS	●	●	●	—	—	—	—	—	—
FX3S-10MT-ESS	●	●	●	—	—	—	—	—	—
FX3S-14MR-ES	●	●	●	—	—	—	—	—	—
FX3S-14MT-ESS	●	●	●	—	—	—	—	—	—
FX3S-20MR-ES	●	●	●	—	—	—	—	—	—
FX3S-20MT-ESS	●	●	●	—	—	—	—	—	—
FX3S-30MR-ES	●	●	●	—	—	—	—	—	—
FX3S-30MT-ESS	●	●	●	—	—	—	—	—	—
<b>FX3G base units</b>									
FX3G-14MR/ES	●	●	●	—	—	—	—	—	—
FX3G-14MT/ESS	●	●	●	—	—	—	—	—	—
FX3G-14MR/DS	●	●	●	—	—	—	—	—	—
FX3G-14MT/DSS	●	●	●	—	—	—	—	—	—
FX3G-24MR/ES	●	●	●	—	—	—	—	—	—
FX3G-24MT/ESS	●	●	●	—	—	—	—	—	—
FX3G-24MR/DS	●	●	●	—	—	—	—	—	—
FX3G-24MT/DSS	●	●	●	—	—	—	—	—	—
FX3G-40MR/ES	●	●	●	—	—	—	—	—	—
FX3G-40MT/ESS	●	●	●	—	—	—	—	—	—
FX3G-40MR/DS	●	●	●	—	—	—	—	—	—
FX3G-40MT/DSS	●	●	●	—	—	—	—	—	—
FX3G-60MR/ES	●	●	●	—	—	—	—	—	—
FX3G-60MR/DS	●	●	●	—	—	—	—	—	—
FX3G-60MT/ESS	●	●	●	—	—	—	—	—	—
FX3G-60MT/DSS	●	●	●	—	—	—	—	—	—
<b>FX3GE base units</b>									
FX3GE-24MT/ESS	●	●	●	—	—	—	—	—	—
FX3GE-40MT/ESS	●	●	●	—	—	—	—	—	—
FX3GE-24MR/DS	●	●	●	—	—	—	—	—	—
FX3GE-24MT/DS	●	●	●	—	—	—	—	—	—
FX3GE-24MT/DSS	●	●	●	—	—	—	—	—	—
FX3GE-40MR/DS	●	●	●	—	—	—	—	—	—
FX3GE-40MT/DS	●	●	●	—	—	—	—	—	—
FX3GE-40MT/DSS	●	●	●	—	—	—	—	—	—
<b>FX3GC base units</b>									
FX3GC-32MT/DSS	●	●	●	—	—	—	—	—	—

\*LVD = Low Voltage Directive

Module type	CE		UL cUL	Ship approvals					
	EMC	LVD*		ABS	DNV	LR	GL	BV	RINA
<b>FX3U base units</b>									
FX3U-16□	●	●	●	●	●	●	●	●	●
FX3U-32□	●	●	●	●	●	●	●	●	●
FX3U-48□	●	●	●	●	●	●	●	●	●
FX3U-64□	●	●	●	●	●	●	●	●	●
FX3U-80□	●	●	●	●	●	●	●	●	●
FX3U-128□	●	●	●	●	●	●	●	●	●
<b>FX3UC base units</b>									
FX3UC-16MT/DSS	●	●	●	—	●	—	—	—	—
FX3UC-32MT/DSS	●	●	●	—	●	—	—	—	—
FX3UC-64MT/DSS	●	●	●	—	●	—	—	—	—
FX3UC-96MT/DSS	●	●	●	—	●	—	—	—	—
<b>FX0N/FX2N extension units</b>									
FX0N-40ER-ES/UL	●	●	●	—	●	—	—	—	—
FX0N-40ER-DS	●	●	—	—	●	—	—	—	—
FX0N-40ET-DSS	●	○	—	—	●	—	—	—	—
FX2N-32ER-ES/UL	●	●	●	●	●	●	●	●	●
FX2N-32ET-ESS/UL	●	●	●	●	●	●	●	●	●
FX2N-48ER-DS	●	●	●	●	●	—	—	—	—
FX2N-48ER-ES/UL	●	●	●	●	●	●	●	●	●
FX2N-48ET-DSS	●	○	●	●	●	—	—	—	●
FX2N-48ET-ESS/UL	●	●	●	●	●	●	●	●	●
<b>FX2N extension blocks</b>									
FX2N-8ER-ES/UL	●	●	●	—	—	—	—	—	—
FX2N-8EX-ES/UL	●	○	●	—	—	—	—	—	—
FX2N-8EYR-ES/UL	●	●	●	—	—	—	—	—	—
FX2N-8EYT-ESS/UL	●	○	●	—	—	—	—	—	—
FX2N-16EX-ES/UL	●	○	●	●	●	●	●	●	●
FX2N-16EYR-ES/UL	●	●	●	●	●	●	●	●	●
FX2N-16EYT-ESS/UL	●	○	●	●	●	●	●	●	●
<b>FX1N/FX2N special function modules</b>									
FX0N-3A	●	—	—	—	—	—	—	—	—
FX2N-1HC	●	●	●	●	●	●	●	●	●
FX2N-2AD	●	○	●	●	—	—	—	—	—
FX2N-2DA	●	○	●	●	—	—	—	—	—
FX2N-2LC	●	○	●	—	—	—	—	—	—
FX2N-4AD	●	○	●	●	●	●	●	●	●
FX2N-4AD-TC	●	○	●	●	●	●	●	●	●
FX2N-4AD-PT	●	○	●	●	●	●	●	●	●
FX2N-4DA	●	○	●	●	●	●	●	●	●
FX2N-5A	●	○	●	—	—	—	●	—	●
FX2N-8AD	●	○	●	—	—	—	●	—	●
FX2N-10PG	●	○	●	—	—	—	—	—	—
FX2N-32CCL	●	○	—	—	—	—	—	—	—
FX2N-32DP-IF	●	●	●	—	—	—	—	—	—
FX2N-64DNET	●	○	●	—	—	—	—	—	—
FX2N-232IF	●	○	—	●	●	●	●	●	●
<b>FX2NC extension blocks</b>									
FX2NC-16EX-T-DS	●	●	●	—	●	●	—	—	—
FX2NC-16EYR-T-DS	●	●	●	—	●	●	—	—	—
FX2NC-16EX-DS	●	●	●	—	●	●	—	—	—
FX2NC-16EYT-DSS	●	●	●	—	●	●	—	—	—
FX2NC-32-EX-DS	●	●	●	—	●	●	—	—	—
FX2NC-32-EYT-DSS	●	●	●	—	●	●	—	—	—

● = comply, ○ = no need to comply

Module type	CE		uL cUL	Ship approvals					
	EMC	LVD*		ABS	DNV	LR	GL	BV	RINA
<b>FX2NC special function modules</b>									
FX2NC-1HC	●	○	●	—	—	—	—	—	—
<b>FX3U special function modules</b>									
FX3U-2HC	●	○	●	—	—	—	—	—	—
FX3U-3A-ADP	●	○	●	—	—	—	—	—	—
FX3U-4AD	●	○	●	—	—	—	—	—	—
FX3U-4DA	●	○	●	—	—	—	—	—	—
FX3U-4AD-TC-ADP	●	○	●	●	●	●	●	●	●
FX3U-4AD-PT-ADP	●	○	●	●	●	●	●	●	●
FX3U-4AD-PNK-ADP	●	○	●	—	—	—	—	—	—
FX3U-4AD-PTW-ADP	●	○	●	—	—	—	—	—	—
FX3U-4AD-ADP	●	○	●	●	●	●	●	●	●
FX3U-4DA-ADP	●	○	●	●	●	●	●	●	●
FX3U-4HSX-ADP	●	○	●	●	●	●	●	●	●
FX3U-4LC	●	○	●	—	—	—	—	—	—
FX3U-CF-ADP	●	○	●	—	—	—	—	—	—
FX3U-2HSY-ADP	●	○	●	●	●	●	●	●	●
FX3U-20SSC-H	●	○	●	—	—	—	—	—	—
FX3U-485ADP-MB	●	○	●	—	—	—	●	●	—
FX3U-232ADP-MB	●	○	●	—	—	—	●	●	—
FX3U-ENET-ADP	●	○	●	—	—	—	—	—	—
FX3U-ENET	●	○	●	—	—	—	—	—	—
FX3U-CAN	●	○	●	●	●	●	●	●	●
FX3U-64DP-M	●	○	●	—	—	—	—	—	—
FX3U-64CCL	●	—	●	—	—	—	—	—	—
FX3U-J1939	●	○	●	●	●	●	●	●	●
FX3U-1PG	●	○	●	—	—	—	—	—	—
<b>Adapter boards</b>									
FX2N-CNV-BD	●	○	—	—	—	—	—	—	—
FX3G-1DA-BD	●	○	—	—	—	—	—	—	—
FX3G-2AD-BD	●	○	—	—	—	—	—	—	—
FX3G-8AV-BD	●	○	—	—	—	—	—	—	—
FX3G-232-BD	●	○	—	—	—	—	—	—	—
FX3G-422-BD	●	○	—	—	—	—	—	—	—
FX3G-485-BD	●	○	—	—	—	—	—	—	—
FX3U-232-BD	●	○	—	●	●	●	●	●	●
FX3U-422-BD	●	○	—	●	●	●	●	●	●
FX3U-485-BD	●	○	—	●	●	●	●	●	●
FX3U-CNV-BD	●	○	—	●	●	●	●	●	●
FX3U-USB-BD	●	○	—	●	●	●	●	●	●
FX3S-CNV-ADP	●	○	●	—	—	—	—	—	—
FX3G-CNV-ADP	●	○	●	—	—	—	—	—	—

\*LVD = Low Voltage Directive

Module type	CE		uL cUL	Ship approvals					
	EMC	LVD*		ABS	DNV	LR	GL	BV	RINA
<b>Terminal blocks</b>									
TB-20S	—	○	●	—	—	—	—	—	—
TB-20C	—	○	●	—	—	—	—	—	—
<b>Accessories</b>									
ALPHA POWER 24	●	●	●	—	—	—	—	—	—
FX-10DM-E	●	○	—	—	—	—	—	—	—
FX-20 P-E-SET0	●	○	—	—	—	—	—	—	—
FX-USB-AW	●	○	—	—	—	—	—	—	—
FX-232AWC-H	●	○	—	—	—	—	—	—	—
FX2N-CNV-IF	●	○	—	●	—	—	—	—	—
FX2NC-CNV-IF	●	○	—	—	●	●	—	—	—
FX3U-1PSU-5V	—	—	—	—	—	—	—	—	—
FX3UC-1PS-5V	—	—	—	—	●	—	—	—	—
FX3U-7DM	●	○	—	●	●	●	●	●	●
FX3U-7DM-HLD	●	—	—	—	—	—	—	—	—

● = comply, ○ = no need to comply

<b>A</b>		<b>E</b>		<b>S</b>	
Accessories .....	12	Extension adapter .....	46	Specifications .....	10
ALPHA 2 series .....	12	Analog adapter .....	46	Alpha 2 series .....	10
24 V power supply unit .....	52	Analog setpoint adapter .....	47	FX3GC series .....	22
AS-Interface module AL2-ASI-BD .....	12	Communications adapter .....	47	FX3GE series .....	22
Cables .....	53	Digital extension adapter .....	46	FX3G Series .....	22
GSM Cable .....	12	FX3G-CNV-ADP .....	47	FX3S series .....	15
Interface Cable .....	12	FX3S-CNV-ADP .....	47	FX3UC series .....	29
Memory cassette .....	12	FX3U-CNV-BD .....	47	FX3U series .....	26
FX series .....	49	Interface adapters .....	48	System Description ALPHA .....	4
5 V power supply unit .....	52	Extension Modules .....	11	System Description MELSEC FX family .....	4
24 V power supply unit .....	52	Analog extension modules ALPHA 2 .....	11	Calculation of the power consumption .....	7
Backup batteries .....	52	Digital extension modules ALPHA 2 .....	11	Components .....	6
Cables .....	53	<b>H</b>		Expandability and power .....	4
Connection terminals .....	51	High-speed counter .....	37	Features .....	5
Display modules .....	54	Adapters .....	37	Sample calculations .....	7
Expansion adapter .....	49	Modules .....	37	<b>T</b>	
Memory media .....	49	<b>I</b>		Temperature control module .....	36
Programming cables .....	53	Interface adapters .....	48	<b>U</b>	
Terminal blocks .....	50	Interface modules .....	44	Unit components .....	8
Terminal connection cable .....	51	FX2N-232IF .....	45	ALPHA 2 series .....	8
Analog Modules .....	33	FX3U-232ADP-MB .....	45	FX3GC series .....	20
Analog input modules .....	33	FX3U-485ADP-MB .....	44	FX3GE series .....	18
Analog I/O adapters .....	35	<b>M</b>		FX3G series .....	16
Analog output modules .....	33	Modular extension units .....	31	FX3S series .....	13
Analog temperature input adapters .....	35	<b>N</b>		FX3UC series .....	27
Analog temperature input modules .....	34	Network modules .....	39	FX3U series .....	23
Combined analog I/O modules .....	34	for CANopen .....	43		
<b>B</b>		FX3U-CAN .....	43		
Base units .....	9	for CC-Link .....	39		
ALPHA 2 series .....	9	FX2N-32CCL .....	40		
FX3GC series .....	21	FX3U-16CCL-M .....	39		
FX3GE series .....	19	FX3U-64CCL .....	39		
FX3G Series .....	17	for DeviceNet .....	43		
FX3S series .....	14	FX2N-64DNET .....	43		
FX3UC series .....	28	for Ethernet .....	40		
FX3U Series .....	24	FX3U-ENET .....	40		
<b>C</b>		FX3U-ENET-ADP .....	41		
Compact extension units .....	30	FX3U-ENET-P502 .....	40		
<b>D</b>		for J1939 .....	44		
Data logger module .....	36	FX3U-J1939 .....	44		
Dimensions .....	55	for Profibus DP .....	41		
Adapter modules FX3U .....	58	FX2N-32DP-IF .....	42		
Adapters FX3G .....	60	FX2N-32DP-IF-D .....	42		
ALPHA series .....	55	FX3U-32DP .....	42		
Display panels .....	61	FX3U-64DP-M .....	41		
Extension blocks FX2N .....	58	<b>P</b>			
Extension blocks FX2NC .....	58	Positioning modules .....	38		
Function modules FX2N .....	59	Positioning module for SSCNET .....	38		
Function modules MELSEC FX3U/FX3UC .....	59	FX3U-20SSC-H .....	38		
FX3G base units .....	56	Single-axis positioning modules .....	38		
FX3GC base units .....	57	FX2N-10PG .....	38		
FX3GE base units .....	56	FX3U-1PG .....	38		
FX3S base units .....	56				
FX3U base units .....	57				
FX3UC base units .....	57				
Memory cassettes .....	61				
Terminal blocks .....	60				

# A world of automation solutions

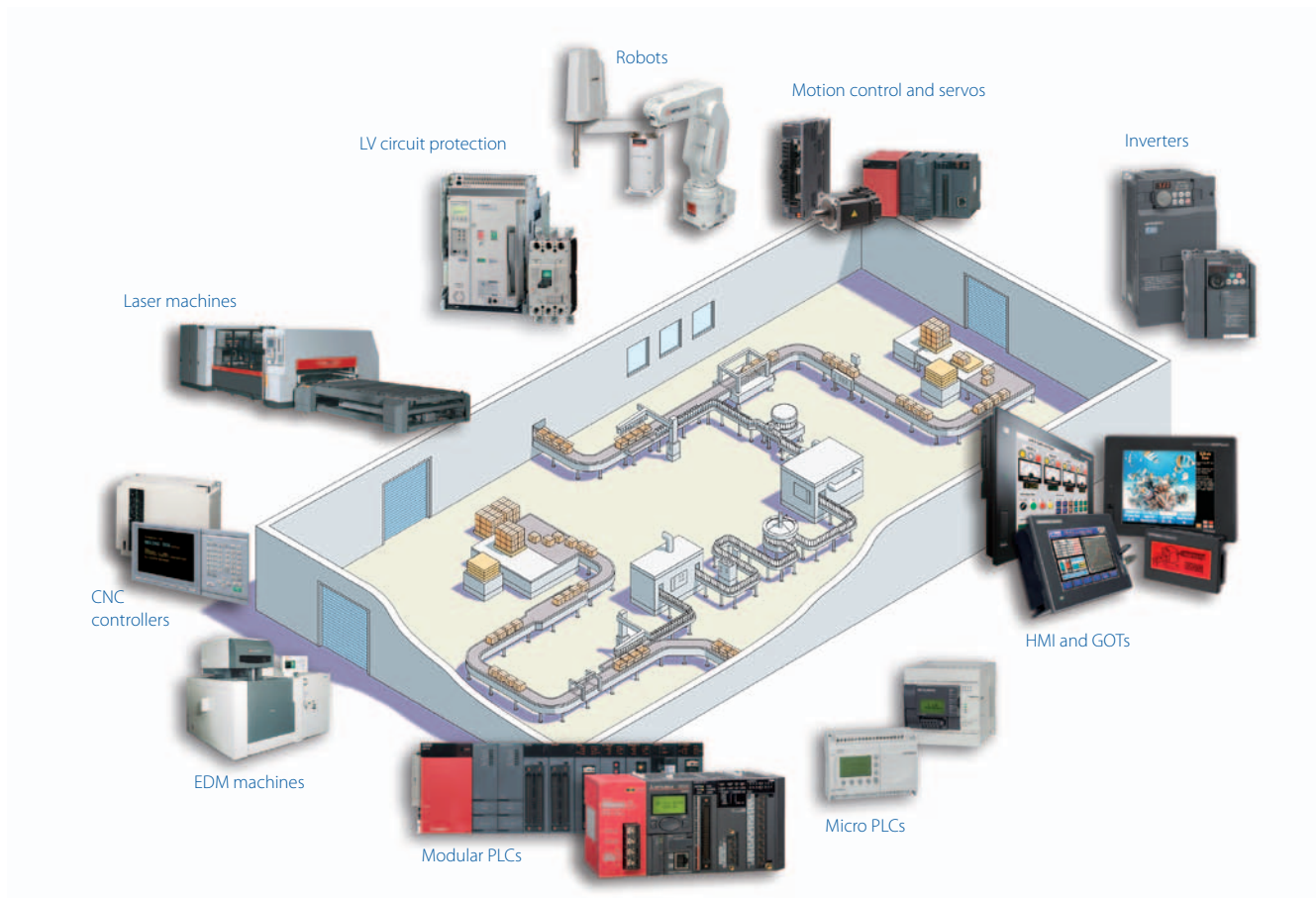

Mitsubishi Electric offers a wide range of automation equipment from PLCs and HMIs to CNC and EDM machines

## A name to trust

Since its beginnings in 1870, some 45 companies use the Mitsubishi name, covering a spectrum of finance, commerce and industry.

The Mitsubishi brand name is recognized around the world as a symbol of premium quality.

Mitsubishi Electric Corporation represents space development, transportation, semi-conductors, energy systems, communications and information processing, audio visual equipment, home electronics, building and energy management and automation systems, and has 237 factories and laboratories worldwide in over 121 countries.

This is why you can rely on a Mitsubishi Electric automation solution – because we know first hand about the need for reliable, efficient, easy-to-use automation and control.

As one of the world's leading companies with a global turnover of 4 trillion Yen (approximately \$40 billion), employing over 100,000 people, Mitsubishi Electric has the resource and the commitment to deliver the ultimate in service and support as well as the best products.

# Global partner. Local friend.

## European Offices

Mitsubishi Electric Europe B.V. Gothaer Straße 8 D-40880 Ratingen Phone: +49 (0)2102 / 486-0	Germany	Mitsubishi Electric Europe B.V. 52. bld. 3 Kosmodamianskaya nab 8 floor RU-115054 Moscow Phone: +7 495 / 721 2070	Russia
Mitsubishi Electric Europe B.V. Radlická 751/113e Avenir Business Park CZ-158 00 Praha 5 Phone: +420 251 551 470	Czech Rep.	Mitsubishi Electric Europe B.V. Carretera de Rubí 76-80 Apdo. 420 E-08190 Sant Cugat del Vallés (Barcelona) Phone: +34 (0) 93 / 5653131	Spain
Mitsubishi Electric Europe B.V. 25, Boulevard des Bouvets F-92741 Nanterre Cedex Phone: +33 (0)1 / 55 68 55 68	France	Mitsubishi Electric Europe B.V. (Scandinavia) Sweden Fjellvägen 8 SE-22736 Lund Phone: +46 (0) 8 625 10 00	Sweden
Mitsubishi Electric Europe B.V. Viale Colleoni 7 Palazzo Sirio I-20864 Agrate Brianza (MB) Phone: +39 039 / 60 53 1	Italy	Mitsubishi Electric Turkey Elektrik Ürünleri A.Ş. Turkey Serifali Mahallesi Nutuk Sokak No:5 TR-34775 Ümraniye-İSTANBUL Phone: +90 (0)216 / 526 39 90	Turkey
Mitsubishi Electric Europe B.V. Westgate Business Park, Ballymount IRL-Dublin 24 Phone: +353 (0)1 4198800	Ireland	Mitsubishi Electric Europe B.V. Travellers Lane UK-Hatfield, Herts. AL10 8XB Phone: +44 (0)1707 / 28 87 80	UK
Mitsubishi Electric Europe B.V. ul. Krakowska 50 PL-32-083 Balice Phone: +48 (0) 12 630 47 00	Poland	Mitsubishi Electric Europe B.V. Dubai Silicon Oasis United Arab Emirates - Dubai Phone: +971 4 3724716	UAE
		INEA CR Losinjka 4 a HR-10000 Zagreb Phone: +385 (0)1 / 36 940 - 01 / -02 / -03	Croatia
		AutoCont C.S. S.R.O. Kafkova 1853/3 CZ-702 00 Ostrava 2 Phone: +420 595 691 150	Czech Republic

## Representatives

GEVA Wiener Straße 89 A-2500 Baden Phone: +43 (0)2252 / 85 55 20	Austria	Beijer Electronics A/S Lykkegardsvej 17 DK-4000 Roskilde Phone: +45 (0)46 / 75 76 66	Denmark	Beijer Electronics SIA Ritausmas iela 23 LV-1058 Riga Phone: +371 (0)6 / 784 2280	Latvia	Sirius Trading & Services Aleea Lacul Morii Nr. 3 RO-060841 Bucuresti, Sector 6 Phone: +40 (0)21 / 430 40 06	Romania	I.C. SYSTEMS Ltd. 23 Al-Saad-Al-Alee St. EG-Sarayut, Maadi, Cairo Phone: +20 (0) 2 / 235 98 548	Egypt
OOO TECHNIKON Prospect Nezavisimosti 177-9 BY-220125 Minsk Phone: +375 (0)17 / 393 1177	Belarus	HANS FOLSGAARD A/S Theligaards Torv 1 DK-4600 Køge Phone: +45 4320 8600	Denmark	Beijer Electronics UAB Goštautu g. 3 LT-48324 Kaunas Phone: +370 37 262707	Lithuania	INEA SR d.o.o. Ul. Karadžičeva 12/217 SER-11300 Smederevo Phone: +381 (0)64 / 68 55 187	Serbia	GIRIT CELADON Ltd. 12 Haomanut Street IL-42505 Netanya Phone: +972 (0)9 / 863 39 80	Israel
ESCO DRIVES Culliganlaan 3 BE-1831 Diegem Phone: +32 (0)2 / 717 64 60	Belgium	Beijer Electronics Eesti OÜ Pärnu mnt.160i EE-11317 Tallinn Phone: +372 (0)6 / 51 81 40	Estonia	ALFATRADER Ltd. 99, Paola Hill Malta-Paola PLA 1702 Phone: +356 (0)21 / 697 816	Malta	SIMAP SK Jána Derku 1671 SK-911 01 Trenčín Phone: +421 (0)32 743 04 72	Slovakia	CEG LIBAN Cebaco Center/Block A Autostrade DORA Lebanon-Beirut Phone: +961 (0)1 / 240 445	Lebanon
KONING & HARTMAN B.V. Woluweelaan 31 BE-1800 Wilvoorde Phone: +32 (0)2 / 257 02 40	Belgium	Beijer Electronics OY Vanha Nurmijärventie 62 FIN-01670 Vantaa Phone: +358 (0)207 / 463 500	Finland	INTEHISIS SRL bld. Traian 23/1 MD-2060 Kishinev Phone: +373 (0)22 / 66 4242	Moldova	INEA RBT d.o.o. Stegne 11 SI-1000 Ljubljana Phone: +386 (0)1 / 513 8116	Slovenia	ADROIT TECHNOLOGIES 20 Waterford Office Park 189 Witkoppen Road ZA-Fourways Phone: +27 (0)11 / 658 8100	South Africa
INEA RBT d.o.o. Stegne 11 SI-1000 Ljubljana Phone: +386 (0)1 / 513 8116	Bosnia and Herzeg.	PROVENDOR OY Teljänkatu 8 A3 FIN-28130 Pori Phone: +358 (0) 2 / 522 3300	Finland	HIFLEX AUTOM. B.V. Wolwevestaat 22 NL-2984 CD Ridderkerk Phone: +31 (0)180 / 46 60 04	Netherlands	Beijer Electronics Automation AB Box 426 SE-20124 Malmö Phone: +46 (0)40 / 35 86 00	Sweden		
AKHNATON 4, Andrei Lipachev Blvd., PO Box 21 BG-1756 Sofia Phone: +359 (0)2 / 817 6000	Bulgaria	UTECO A.B.E.E. 5, Mavrogenous Str. GR-18542 Piraeus Phone: +30 (0)211 / 1206-900	Greece	KONING & HARTMAN B.V. Haarlebbergweg 21-23 NL-1101 CH Amsterdam Phone: +31 (0)20 / 587 76 00	Netherlands	OMNI RAY AG Im Schörlöf CH-8600 Dübendorf Phone: +41 (0)44 / 802 28 80	Switzerland		
INEA CR Losinjka 4 a HR-10000 Zagreb Phone: +385 (0)1 / 36 940 - 01 / -02 / -03	Croatia	MELTRADE Kft. Fertő utca 14, HU-1107 Budapest Phone: +36 (0)1 / 431-9726	Hungary	Beijer Electronics AS Postboks 487 NO-3002 Drammen Phone: +47 (0)32 / 24 30 00	Norway	OOO "CSC-AUTOMATION" 4-B, M. Raskovnyi St. UA-02660 Kiev Phone: +380 (0)44 / 494 33 44	Ukraine		
AutoCont C.S. S.R.O. Kafkova 1853/3 CZ-702 00 Ostrava 2 Phone: +420 595 691 150	Czech Republic	TOO Kazpromavtomatika Ul. Zhambyla 28 KAZ-100017 Karaganda Phone: +7 7212 / 50 10 00	Kazakhstan	Fonseca S.A. R. João Francisco do Casal 87/89 PT-3801-997 Aveiro, Esqueira Phone: +351 (0)234 / 303 900	Portugal				



Version check

Mitsubishi Electric Europe B.V. / FA - European Business Group / Gothaer Straße 8 / D-40880 Ratingen / Germany / Tel.: +49(0)2102-4860 / Fax: +49(0)2102-4861120 / info@mitsubishi-automation.de / https://eu3a.mitsubishielectric.com

Art. no. 167840-G / 02.2014 / Specifications subject to change / All trademarks and copyrights acknowledged.

