



Interlock Switches

Plastic Slide Handle Actuator for HS5 Series



Plastic & Aluminum Hybrid Lightweight Actuator

Ensures a safe working environment

New Slide Handle Actuator

Plastic & Aluminum Hybrid Structure

Actuator with key also available for various working environments

*See page 5 for details

The slide handle actuator supports 4-way operation (left/right door, sliding door/opening door) and prevents workers from being trapped in hazardous areas, creating a safe working environment.



* Image: actuator with key.
Actuators with key or without key types are available.

Interlock switches



Plastic & Aluminum

Hybrid design

Compact, lightweight but robust

The mounting part that fixes the actuator on to the safety guard is made of aluminum.

Aluminum

Plastic



Emergency escape from inside hazardous areas

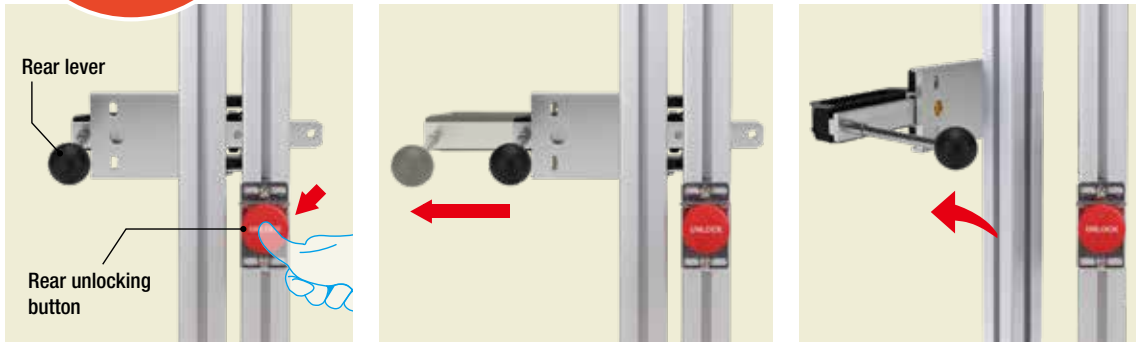

- 1** Push the rear unlocking button to release the lock and stop the hazard.
- 2** Slide the lever.
- 3** Open the door and escape.

Rear unlocking button kit for frame mounting (HS9Z-FL5*: optional)

Even if an operator is trapped inside the hazardous area, the operator can escape by unlocking the rear unlocking button and by sliding the lever from inside to open the door.

(Only when using the HS5L rear unlocking button model. Use with an optional rear unlocking button kit for frame mounting.)

ANSI/RIA R15.06-1999 11.2.2 Interlocking portion

- b) The interlocking portion of the interlocked barrier shall be installed, applied, and maintained so that:
- 8) be capable of being easily unlocked from the inside of the safeguarded space with or without power available, when the possibility of full body access exists;



Press the **red button** in case of an **emergency PUSH for Safety**



Two-step action prevents inadvertent operation

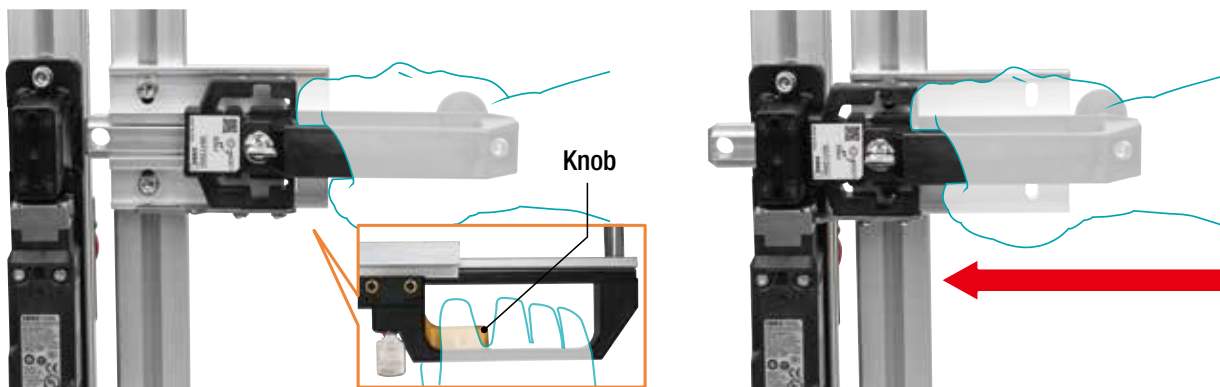

- 1** Grab the handle, and grip the knob to unlatch.
- 2** While gripping the knob, slide the handle and insert the actuator.

When inserting the actuator, **1** unlatch the knob, **2** slide the handle. Two-step action prevents the handle from inadvertent operation.



Hostage key

The plastic slide handle actuator with key has a keyhole on the handle of the actuator. When the key is turned and removed, the handle is locked to prevent unintended operation by other workers. It also prevents the machine from operating unexpectedly, ensuring the safety of workers. There are 16 different key numbers, which can be used in combination with the key selector switch.

See page 5 for details

• Without key



• With key

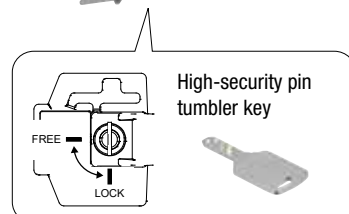

* Above example is for right opening doors.



Padlock Hole

Even with actuators without key, by installing the padlock, unintended operation of other operators can be prevented after the door is opened.

(Padlocks must be purchased by the customer)

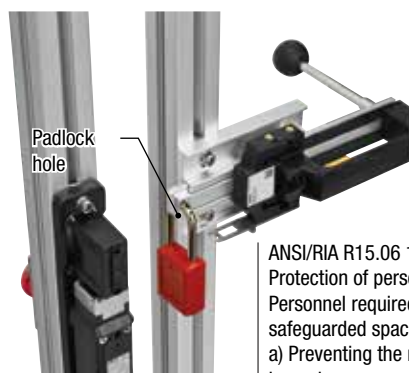

ANSI/RIA R15.06 1999 8.4
Protection of personnel within the safeguarded space
Personnel required to perform tasks within the safeguarded space shall be protected by:
a) Preventing the re-initiation of any motion or hazardous process while personnel are within the safeguarded space, for example locking a gate open;

Interlock Switches

Interlock Switches



Interlock switch with rear unlocking button

Interlock Switches with Solenoid

HS5L

Spring lock Interlock switch

2-contact / 4-contact
Compact body with 1400N locking force

For interlock switches with locking features, use a interlock switch with rear unlocking button. Also, be sure to use a rear unlocking button kit for frame mounting.
(See each product catalog for details.)



Interlock Switches

HS5D

3 total contacts - dual contact and monitoring contact.
Detects detachment of head for enhanced safety.

ø22mm Switches & Pilot Lights Key Selector Switches

Key Selector Switches

See page 10 and 11 for details.



HW Series

Pin tumbler key

- Hostage control feature can be achieved when used with interlock switches.
- Sixteen types of key numbers are available.
- Wide variety of choices from 2- or 3-position, maintained, and spring return. Key retained position can be designated.
- High-security pin tumbler key.



Hostage Control

Plastic slide handle actuators with key uses the key to lock the handle of the actuator. When the key is taken into a hazardous area, the interlock switch cannot be locked because the actuator cannot be inserted and the machine does not operate. Therefore, operators can be prevented from being locked in a hazardous area, and the system reverted from restarting unexpectedly. Furthermore, because the key used for the plastic slide handle actuator can also be used for HW series key selector switches (pin tumbler type), switching of system operation modes and door unlocking can be performed using a single key.

The key used for the above purpose is called a "hostage key" and the act of ensuring the safety of workers using a hostage key is called "hostage control".

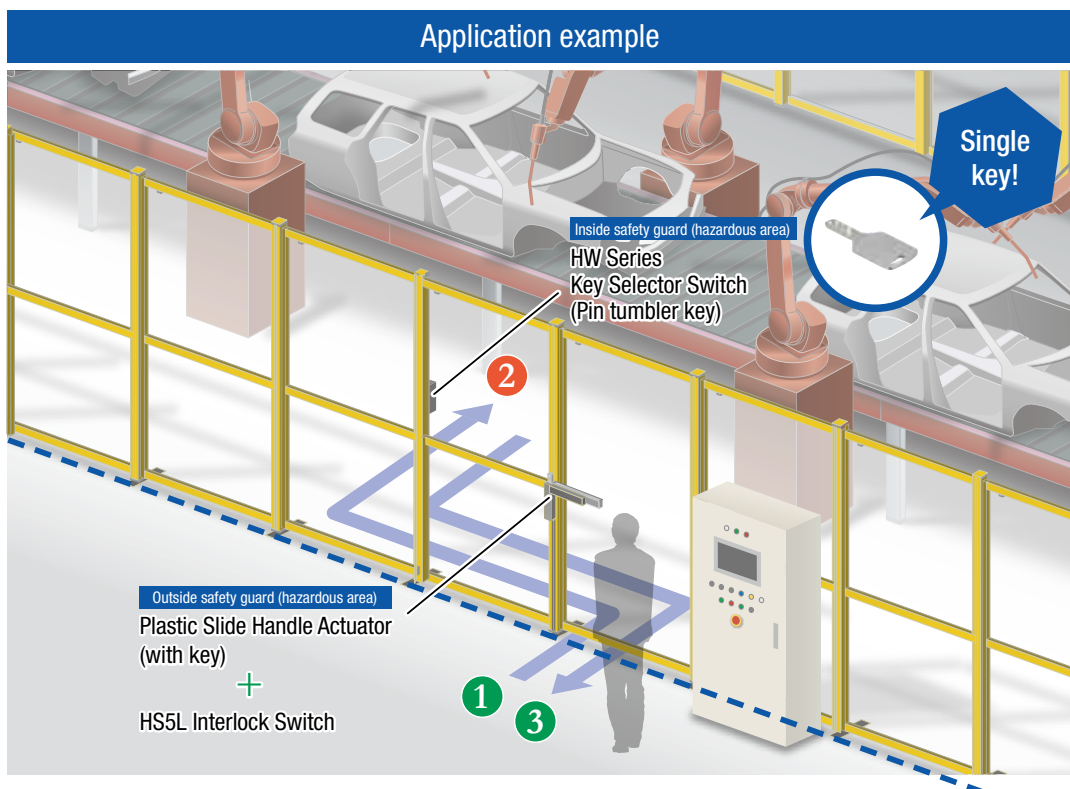

1 Outside the safety guard

1. Unlock the interlock on the safety guard.
2. Slide the handle of the actuator. When the handle is firm in place, turn and remove the key.
3. Open the safety guard. Take the key inside.

2 Inside the safety guard

1. Using the key taken inside the hazardous area, change the mode of the control device from operating mode to maintenance mode and start maintenance work.
2. After maintenance is complete, change to operating mode, remove the key and take the key outside the safety guard.

3 Outside the safety guard

1. Take the key outside the safety guard.
2. Insert the key in the slide handle actuator, unlock the handle. Then slide the handle and insert the actuator.
3. Lock the interlock switch to complete the maintenance work.

Plastic slide handle actuator with key

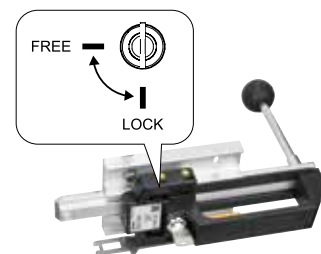

HW series key selector switch (pin tumbler key)



Plastic Slide Handle Actuator for HS5 Series

**Plastic & Aluminum Structure ensures strength and durability.
Actuators with key and without key available.**

Plastic Slide Handle Actuator for HS5 Series

Package Quantity: 1

Name	Part No.	Key	Rear lever	Remarks
Plastic slide handle actuator for HS5 Series	HS9Z-LH5	-	-	Used with an interlock switch
	HS9Z-LH5K	√	-	
	HS9Z-LH5L	-	√	
	HS9Z-LH5KL	√	√	
Rear unlocking button kit for frame (*1)	HS9Z-FL54	-	-	Thickness of mounting part (*2) (Y): 30≤Y≤35 (mm)
	HS9Z-FL55			Thickness of mounting part (*2) (Y): 35<Y≤45 (mm)
	[HS9Z-FL56]			Thickness of mounting part (*2) (Y): 45<Y≤55 (mm)
	[HS9Z-FL57]			Thickness of mounting part (*2) (Y): 55<Y≤65 (mm)

*1) Must be purchased when using a HS5L-*L rear unlocking button model (sold separately)

*2) Mounting part refers to a part where the product will be attached (such as a frame).

- Items in [] are not for standard sale. To order, contact IDEC.
- For other panel thickness, contact IDEC.
- See key number designation below to specify key numbers.

Key number designation

Part No. Example: HS9Z-LH5KL-501

Key function
Blank: None
K: with key

Blank: 500 (default key)
501 - 515 : The key number is engraved on the key cylinder.

Rear lever
Blank: None
L: with lever

Specification

Applicable interlock switch	HS5D interlock switch HS5L interlock switch with rear unlocking button (*1)
Weight (approx.)	650g (HS9Z-LH5L), 700g (HS9Z-LH5KL)
Operating temperature	-30 to +70°C (no freezing)
Mechanical durability	100,000 operations minimum (key removal: 10,000 times min.)
Applicable padlock shackle diameter	ø6 to 9mm
Padlock withstand load	50N minimum
Handle travel (approx.)	80mm (removed <—>inserted)

*1) When using an interlock switch with a lock feature, the use of a rear unlocking button is recommended.

- The interlock switch must be prepared by the customer.
- For details on interlock switches, see specifications for each product.

Parts description

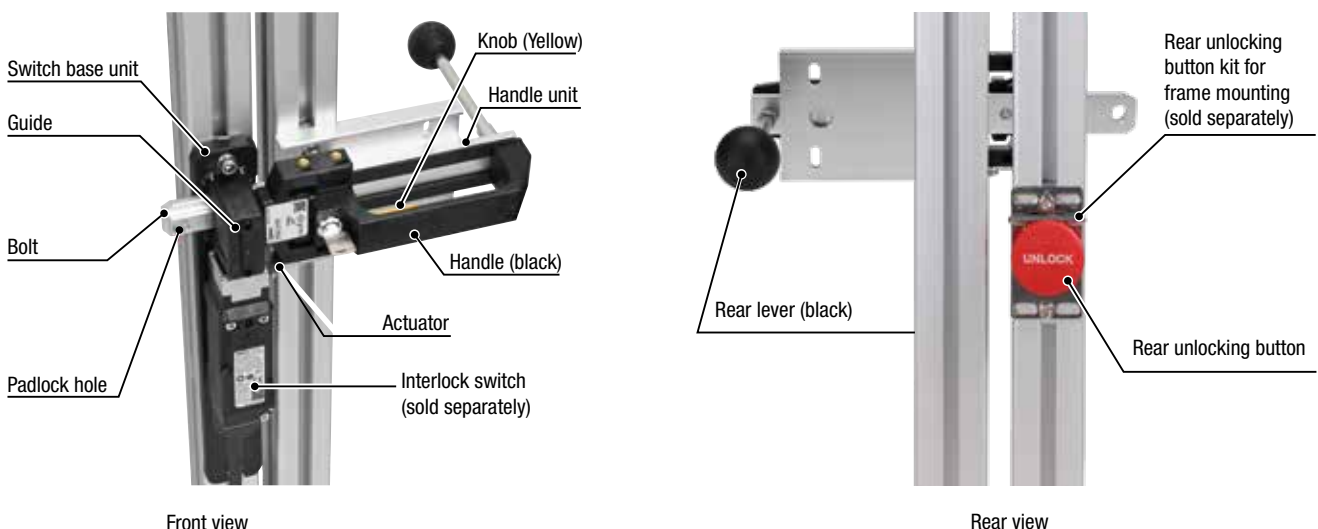

Dimensions

Dimensions in mm.

HS9Z-LH5KL

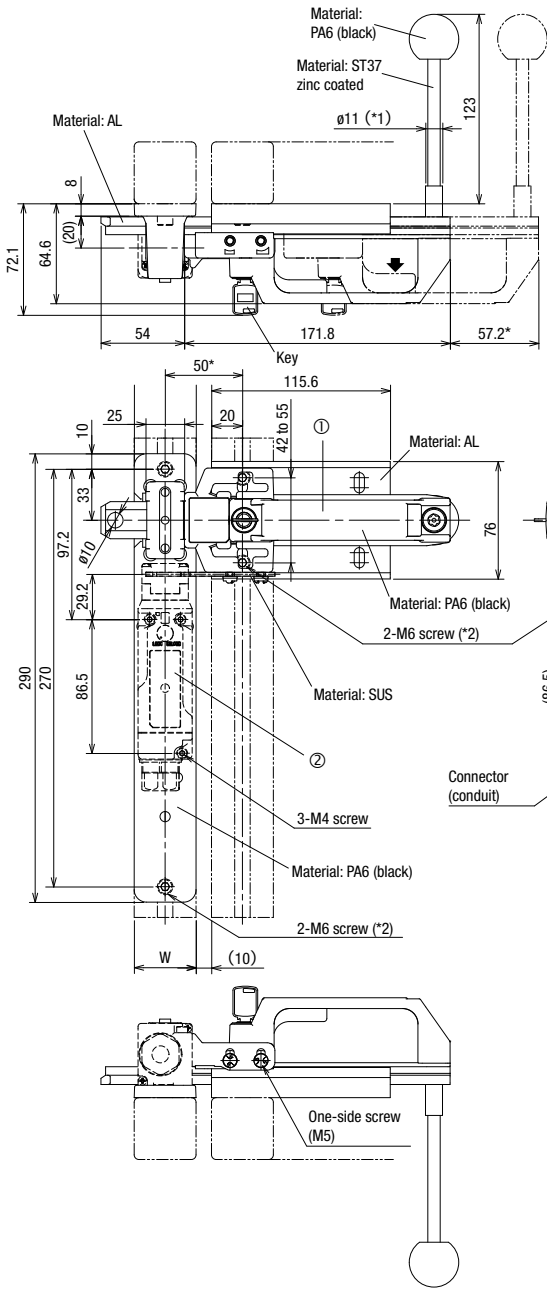

No.	Name
①	HS9Z-LH5KL Plastic slide handle actuator
②	HS5L interlock switch spring lock type (HS5L-□44**-G: sold separately)

HS5L-□44*SM-G
(Side-conduit model)

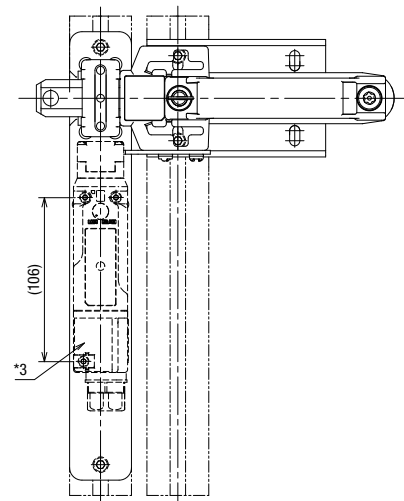

In the example shown on the left, a □40mm frame is used.

- *1) Mount the product before operation and ensure that rear lever does not interfere with the frame.
- *2) When choosing mounting part (frame), note that the mounting screws are M6
- *3) When using the actuator on side-conduit model (HS5L-□44*SM), rotate the terminal cover 180° from the direction that the unit is shipped.

Panel cut-out

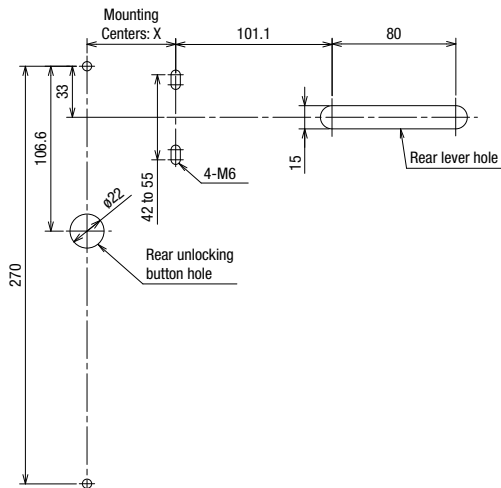

Applicable frame size (hinged door)

Frame Size: W (dimensions in mm.)	Mounting Centers (dimensions in mm.)
$40 \leq W < 45$	$50 \leq X \leq 60$
$45 \leq W < 50$	$55 \leq X \leq 65$
$50 \leq W \leq 55$	$60 \leq X \leq 70$
$55 < W \leq 60$	$65 \leq X \leq 70$

- Make sure to observe the applicable frame size, otherwise the actuator cannot be inserted/removed properly.

⚠ Safety Precautions

- Turn off the power to the product before starting installation, removal, wiring, maintenance, and inspection of the products. Failure to turn power off may cause electrical shocks or fire hazard.
- Do not disassemble or modify the product, otherwise a breakdown or an accident may occur.
- The slide handle actuator can only be used with applicable interlock switches. Do not use with other interlock switches.
- When using the slide handle actuator in the safety-related part of the system, make sure of proper operation while observing the safety standards and regulations of the relevant country or region where the actual machine/system is used. Also, perform a risk assessment before operation.
- Read the instruction sheet of the applicable interlock switch before installing the slide handle actuator.
- Do not apply load of more than 1400N when the door is in a locked status, otherwise malfunction may occur.
- If the product is deformed or damaged, immediately replace with a new product.
- Do not open the door with the actuator inserted in the interlock switch. Otherwise, malfunction or damage may occur. If double doors are used, strong force may be applied to the doorbolt (bolt and handle unit) and cause deformation or damage.
- Install the slide handle actuator on the outside of the door. Do not install inside the door, otherwise the door cannot be opened or closed by the operator, affecting the operation and causing danger to the operator.
- Do not close the door when the bolt is slide out, otherwise damage will result.
- Install the slide handle actuator as shown at right, so that the cable hub faces downward. Do not install in any other direction.

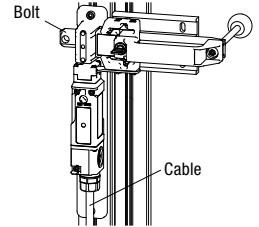

Instructions

For details on mounting, wiring, and circuit examples, see the instruction manual from the below URL.
<https://product.idec.com/?product=HS9Z-LH>



Handle Operation

- When inserting the actuator, fully grip the knob, and then move the handle as shown below.

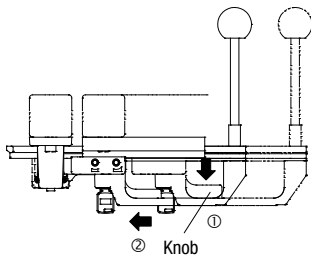

- Do not operate the without gripping the knob. Operating by force may cause malfunction.

Padlock hole

- Install the padlock or hasp on the padlock hole as shown below.

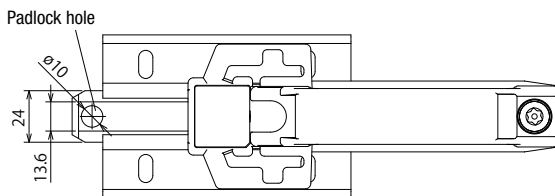

- Make sure that the load on the padlock bolt does not exceed 50N, otherwise the slide handle actuator may be deformed or damaged.
- The applicable shackle diameter is ø6 to 9.

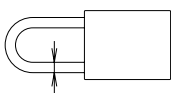

Applicable shackle diameter: ø6 to 9mm

Rear lever

- The actuator cannot be inserted using the rear lever.

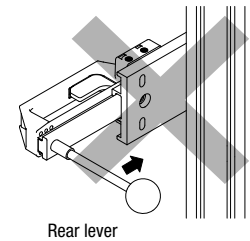

Key Operation

Key position	Key operation	Knob operation
FREE	Retained	Possible
LOCK	Removable	Not possible

Note) When the door is open, turn the key to LOCK and remove the key. Make sure that the actuator cannot be operated by other operators.

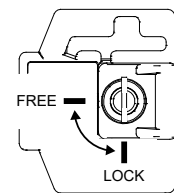

Observe the following instructions to prevent malfunction or damage.

- Be sure to insert the key to the bottom of the key hole.
- Do not apply rotation force when removing or inserting the key. Also, do not pull the key while rotating.
- 15 types of key numbers are available in addition to a standard key. Use a key that matches with the number on the key cylinder.
- Do not apply rotating force that exceeds the operating force range of the key.
- Do not turn the key to LOCK while gripping the knob or when the actuator is inserted.
- When the key is turned to LOCK, do not operate the knob or insert the actuator by force.

Instructions

Mounting

Confirm that the package contains the following parts.

Parts	Number of parts included			
	HS9Z-LH5	HS9Z-LH5L	HS9Z-LH5K	HS9Z-LH5KL
① Switch base unit	1	1	1	1
② Handle unit	With key	0	1	1
	Without key	1	1	0
③ Actuator	1	1	1	1
④ Plastic stopper	1	1	1	1
⑤ One-side screw (M5)	2	2	2	2
⑥ Spring washer	2	2	2	2
⑦ Rear lever	0	1	0	1
⑧ Key	0	0	1	1
⑨ Instruction sheet	1	1	1	1

Fasten the switch base unit on the mounting frame or panel. Mounting screws and nuts are not supplied and must be provided by the user.

*HS5L mounting screw thread length 36 to 40mm (M4)

*HS5D mounting screw thread length 27 to 31mm (M4)

Recommended tightening torque

Screw	Recommended tightening torque
For mounting the HS5D interlock switch (M4 screw x 2) *	1.8 to 2.2N·m
For mounting the HS5L interlock switch (M4 screw x 3) *	
For mounting the switch base unit (M6 screw x 2) *	4.5 to 5.5N·m
For mounting the handle unit (M6 screw x 2) *	4.5 to 5.5N·m
For mounting the actuator (M5 one-side screw x 2)	2.7 to 3.3N·m

The above tightening torque of the mounting screw is the value confirmed with hex socket head bolts. When other screws are used and tightened to a smaller torque, make sure that the screws do not become loose after mounting.

Safety Distance and Minimum Gaps

Before installing the slide handle actuator, make sure to take safety distance and safety clearance into consideration in order to secure the distance between the mounting part (frame) and the hazard.

ISO 13852: Safety of machinery – Safety distances to prevent danger zones being reached by the upper limbs

ISO 13853: Safety of machinery – Safety distances to prevent danger zones being reached by the lower limbs

ISO 13854: Safety of machinery – Minimum gaps to avoid crushing of parts of the human body

HW Series Key Selector Switches (Pin Tumbler Key)



Key selector switches with direct opening action mechanism
High-security pin tumbler key



See website for details on approvals and standards.

- The NC contact is opened by direct opening action mechanism. Mode selection enables easy construction of safety systems.
- Hostage control is achieved by combining with HS5 series plastic slide handle actuator
- High-security pin tumbler key is used.
- 16 types of key numbers are available.
- 2-position and 3-position, maintained, spring return types, and various key retained positions available.
- Degree of Protection: IP65 (IEC60529)

Package Quantity: 1

Name / Shape	No. of Positions	Contact Code	Contact Block		Operator Position			Cam Code	Maintained 1 2
			Mounting Position	Contact	1	2			
 Pin tumbler type HW1K  (NC contact only)	90° 2-position	1NC (01)	① NC	●			—	HW1K-2PA01	
			② —		●				Dummy
		1NO-1NC (11)	① NO		●			—	HW1K-2PA11
			② NC	●					
		2NC (02)	① NC	●				—	HW1K-2PA02
			② NC	●					
		2NO-1NC (21)	① NO		●			—	HW1K-2PA21
			② NC	●					
			③ NO		●				
			④ —			●	Dummy		
		3NC (03)	① NC	●				—	HW1K-2PA03
			② NC	●					
		③ NC	●						
		④ —			●	Dummy			
	2NO-2NC (22)	① NO		●			—	HW1K-2PA22	
		② NC	●						
	③ NO		●						
	④ NC	●							

- Each key selector switch is supplied with two keys.
- 15 types of key numbers are available in addition to standard (500) key.
- Spring-return types also available. See below.
- Key retained position can be selected. See below.

Part No. Configuration

HW1K-2JPA01-501

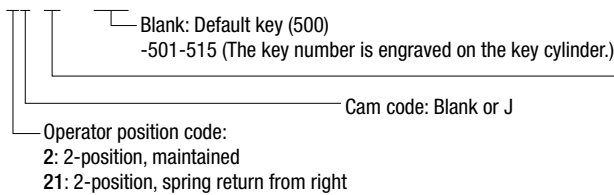

Key removal/retained positions

- A: Removable in all positions
- B: Removable in the left only
- C: Removable in the right only

Maintained (90° 2-position)		Spring Return (60° 2-position)
Cam code: blank	Cam code: J	Spring return from right Cam code: blank

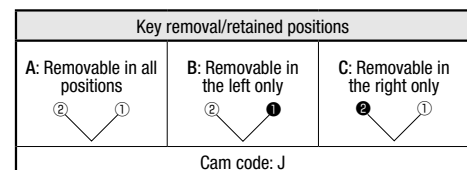
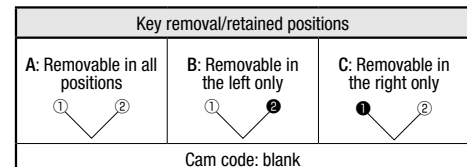

- For other contact arrangements, contact IDEC.
- A dummy block is used for 1 or 3 contact configurations.
- Be sure to turn the key securely to each key position.

①②: Key retained position

Note: The key cannot be removed in a spring return position.

Package Quantity: 1

Name / Shape	No. of Positions	Contact Code	Contact Block		Operator Position			Cam Code	Maintained 1 0 2	
			Mounting Position	Contact	1	0	2			
 Pin tumbler type HW1K	45° 3-position	2NC (02)	①	NC		■		—	HW1K-3PA02	
			②	NC	■					
		2NO-2NC (22N1)	①	NO	●				—	HW1K-3PA22N1
			②	NC		■	●			
		4NC (04)	①	NC		■			—	HW1K-3PA04
			②	NC		■				
			③	NC		■	■			
			④	NC		■				
		2NO-1NC (21N1) ★ ☆	①	NO	●				J	HW1K-3JPA21N1
			②	NO			●			
			③	NC		●				
			④	—		Dummy				
		4NC (04) ★	①	NC				●	S	HW1K-3SPA04
			②	NC	●					
			③	NC				●		
			④	NC	●					

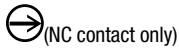

- On the contact code marked with ★ in the table above, the rated current (load switching current) is reduced to a half of the rated current of the contact block. The rated insulation voltage and the rated thermal current remain unchanged.
- For models with ☆, contacts may overlap when the operator position is changed. For contact block mounting position, see the figure on the bottom of the page.
- Each key selector switch is supplied with two keys.
- 15 types of key numbers are available in addition to standard (500) key.
- Spring-return types available. See below.
- Key retained position can be selected. See below.

Part No. Configuration

HW1K-3SPA04-501

Blank: Default key (500)
 -501-515 (The key number is engraved on the key cylinder.)

Operator position code:
 3: 3-position, maintained
 31: 3-position, spring return from right
 32: 3-position, spring return from left
 33: 3-position, spring return two way

Cam code: Blank or J

Key removal/retained positions
 A: Removable in all positions
 B: Removable in the left and center
 C: Removable in the right and center
 D: Removable in center only
 E: Removable in right and left
 G: Removable in left only
 H: Removable in right only

Maintained (45° 3-position)	Spring Return (45° 3-position)		
Cam code: blank, J, or S	Cam code: blank		

Key removal/retained positions (45° 3-position)			
A: Removable in all positions 	B: Removable in the left only 	C: Removable in the right only 	D: Removable in center only
E: Removable in right and left only 	G: Removable in left only 	H: Removable in right only 	

①②: Key retained position
 Note: The key cannot be removed in a spring return position.

- For other contact arrangements, contact IDEC.
- A dummy block is used for 1 or 3 contact configurations.
- Be sure to turn the key securely to each key position.

Contact block mounting position



Ordering Terms and Conditions

Thank you for using IDEC Products.

By purchasing products listed in our catalogs, datasheets, and the like (hereinafter referred to as "Catalogs") you agree to be bound by these terms and conditions. Please read and agree to the terms and conditions before placing your order.

1. Notes on contents of Catalogs

- (1) Rated values, performance values, and specification values of IDEC products listed in this Catalog are values acquired under respective conditions in independent testing, and do not guarantee values gained in combined conditions.
Also, durability varies depending on the usage environment and usage conditions.
- (2) Reference data and reference values listed in Catalogs are for reference purposes only, and do not guarantee that the product will always operate appropriately in that range.
- (3) The specifications / appearance and accessories of IDEC products listed in Catalogs are subject to change or termination of sales without notice, for improvement or other reasons.
- (4) The content of Catalogs is subject to change without notice.

2. Note on applications

- (1) If using IDEC products in combination with other products, confirm the applicable laws / regulations and standards.
Also, confirm that IDEC products are compatible with your systems, machines, devices, and the like by using under the actual conditions. IDEC shall bear no liability whatsoever regarding the compatibility with IDEC products.
- (2) The usage examples and application examples listed in Catalogs are for reference purposes only. Therefore, when introducing a product, confirm the performance and safety of the instruments, devices, and the like before use. Furthermore, regarding these examples, IDEC does not grant license to use IDEC products to you, and IDEC offers no warranties regarding the ownership of intellectual property rights or non-infringement upon the intellectual property rights of third parties.
- (3) When using IDEC products, be cautious when implementing the following.
 - i. Use of IDEC products with sufficient allowance for rating and performance
 - ii. Safety design, including redundant design and malfunction prevention design that prevents other danger and damage even in the event that an IDEC product fails
 - iii. Wiring and installation that ensures the IDEC product used in your system, machine, device, or the like can perform and function according to its specifications
- (4) Continuing to use an IDEC product even after the performance has deteriorated can result in abnormal heat, smoke, fires, and the like due to insulation deterioration or the like. Perform periodic maintenance for IDEC products and the systems, machines, devices, and the like in which they are used.
- (5) IDEC products are developed and manufactured as general-purpose products for general industrial products. They are not intended for use in the following applications, and in the event that you use an IDEC product for these applications, unless otherwise agreed upon between you and IDEC, IDEC shall provide no guarantees whatsoever regarding IDEC products.
 - i. Use in applications that require a high degree of safety, including nuclear power control equipment, transportation equipment (railroads / airplanes / ships / vehicles / vehicle instruments, etc.), equipment for use in outer space, elevating equipment, medical instruments, safety devices, or any other equipment, instruments, or the like that could endanger life or human health
 - ii. Use in applications that require a high degree of reliability, such as provision systems for gas / waterworks / electricity, etc., systems that operate continuously for 24 hours, and settlement systems
 - iii. Use in applications where the product may be handled or used deviating from the specifications or conditions / environment listed in the Catalogs, such as equipment used outdoors or applications in environments subject to chemical pollution or electromagnetic interference
If you would like to use IDEC products in the above applications, be sure to consult with an IDEC sales representative.

3. Inspections

We ask that you implement inspections for IDEC products you purchase without delay, as well as thoroughly keep in mind management/maintenance regarding handling of the product before and during the inspection.

4. Warranty

- (1) Warranty period
The warranty period for IDEC products shall be one (1) year after purchase or delivery to the specified location. However, this shall not apply in cases where there is a different specification in the Catalogs or there is another agreement in place between you and IDEC.
- (2) Warranty scope
Should a failure occur in an IDEC product during the above warranty period for reasons attributable to IDEC, then IDEC shall replace or repair that product, free of charge, at the purchase location / delivery location of the product, or an IDEC service base. However, failures caused by the following reasons shall be deemed outside the scope of this warranty.
 - i. The product was handled or used deviating from the conditions / environment listed in the Catalogs
 - ii. The failure was caused by reasons other than an IDEC product
 - iii. Modification or repair was performed by a party other than IDEC
 - iv. The failure was caused by a software program of a party other than IDEC
 - v. The product was used outside of its original purpose
 - vi. Replacement of maintenance parts, installation of accessories, or the like was not performed properly in accordance with the user's manual and Catalogs
 - vii. The failure could not have been predicted with the scientific and technical standards at the time when the product was shipped from IDEC
 - viii. The failure was due to other causes not attributable to IDEC (including cases of force majeure such as natural disasters and other disasters)
 Furthermore, the warranty described here refers to a warranty on the IDEC product as a unit, and damages induced by the failure of an IDEC product are excluded from this warranty.

5. Limitation of liability

The warranty listed in this Agreement is the full and complete warranty for IDEC products, and IDEC shall bear no liability whatsoever regarding special damages, indirect damages, incidental damages, or passive damages that occurred due to an IDEC product.

6. Service scope

The prices of IDEC products do not include the cost of services, such as dispatching technicians. Therefore, separate fees are required in the following cases.

- (1) Instructions for installation / adjustment and accompaniment at test operation (including creating application software and testing operation, etc.)
- (2) Maintenance inspections, adjustments, and repairs
- (3) Technical instructions and technical training
- (4) Product tests or inspections specified by you

The above content assumes transactions and usage within your region. Please consult with an IDEC sales representative regarding transactions and usage outside of your region. Also, IDEC provides no guarantees whatsoever regarding IDEC products sold outside your region.

IDEC CORPORATION

Head Office 6-64, Nishi-Miyahara-2-Chome, Yodogawa-ku, Osaka 532-0004, Japan

USA	IDEC Corporation	Singapore	IDEC Izumi Asia Pte. Ltd.
EMEA	APEM SAS	Thailand	IDEC Asia (Thailand) Co., Ltd.
		India	IDEC Controls India Private Ltd.

China	IDEC (Shanghai) Corporation	Japan	IDEC Corporation
	IDEC Izumi (H.K.) Co., Ltd.		
Taiwan	IDEC Taiwan Corporation		

 www.idec.com

Specifications and other descriptions in this brochure are subject to change without notice.
Information in this brochure is current as of September, 2021.
2021 IDEC Corporation, All Rights Reserved.

EP1755-0

