



for a greener tomorrow



**mitsubishi  
ELECTRIC**

*Changes for the Better*

FACTORY AUTOMATION

# SERVO AMPLIFIERS & MOTORS

## MELSERVO-JE

MITSUBISHI SERVO AMPLIFIERS & MOTORS

# MELSERVO JE



# GLOBAL IMPACT OF MITSUBISHI ELECTRIC



Through Mitsubishi Electric's vision, "Changes for the Better" are possible for a brighter future.

## ***Changes for the Better***

We bring together the best minds to create the best technologies. At Mitsubishi Electric, we understand that technology is the driving force of change in our lives. By bringing greater comfort to daily life, maximizing the efficiency of businesses and keeping things running across society, we integrate technology and innovation to bring changes for the better.

Mitsubishi Electric is involved in many areas including the following

### **Energy and Electric Systems**

A wide range of power and electrical products from generators to large-scale displays.

### **Electronic Devices**

A wide portfolio of cutting-edge semiconductor devices for systems and products.

### **Home Appliance**

Dependable consumer products like air conditioners and home entertainment systems.

### **Information and Communication Systems**

Commercial and consumer-centric equipment, products and systems.

### **Industrial Automation Systems**

Maximizing productivity and efficiency with cutting-edge automation technology.

# OVERVIEW

 <b>MR-JE-C</b>	<ul style="list-style-type: none"> <li>CC-Link IE Field Network Basic ..... 7</li> <li>Various Drive System Configurations ..... 8</li> <li>Multi-Axis System with MR-JE-C ..... 10</li> </ul>
 <b>MR-JE-B</b>	<ul style="list-style-type: none"> <li>SSCNET III/H ..... 11</li> <li>Advanced Motion Control by Combination with Simple Motion Module ..... 12</li> <li>Example of Machine Applications ..... 13</li> </ul>
 <b>Easy To Use</b>	<ul style="list-style-type: none"> <li>High-Precision Tuning ..... 15</li> <li>For Changes in Power Supply Environment ..... 16</li> <li>Useful Functions for Your System ..... 16</li> <li>A Variety of Positioning Functions ..... 17</li> <li>Positioning Using Communication Function ..... 19</li> <li>Easy Monitoring and Maintenance ..... 19</li> <li>User-Friendly Motors ..... 20</li> <li>Servo Setup Software (MR Configurator2) ..... 21</li> </ul>
 <b>High Performance</b>	<ul style="list-style-type: none"> <li>Fast and Accurate ..... 23</li> <li>Eco-Friendly Performance ..... 24</li> </ul>
 <b>Global Standard</b>	<ul style="list-style-type: none"> <li>Global Standards ..... 25</li> <li>Global FA Centers ..... 26</li> </ul>
 <b>Product Specifications</b>	<ul style="list-style-type: none"> <li>Servo Amplifiers ..... 1-1</li> <li>Servo Motors ..... 2-1</li> <li>Options/Peripheral Equipment ..... 3-1</li> <li>LVS/Wires ..... 4-1</li> <li>Product List ..... 5-1</li> <li>Cautions ..... 6-1</li> </ul>



Apply servos to all machines with

### **Easy To Use**

#### **One-Touch Tuning**

Servo gains are adjusted with one-touch ease without a personal computer.

#### **Tolerance against Instantaneous Power Failure**

The instantaneous power failure tough drive function and the large capacity capacitor reduce machine downtime.

#### **Absolute Position Detection System**

MR-JE-C and MR-JE-B support absolute position detection system.

#### **Built-in Positioning Function**

MR-JE-C and MR-JE-A have a built-in positioning function, enabling positioning operation with point table method, etc. MR-JE-A is equipped with advanced functions such as simple cam and position compensation.

MITSUBISHI SERVO AMPLIFIERS & MOTORS

# MELSERVO JIE

Ethernet-Compatible MR-JE-C  
is Now Available **NEW**

CC-Link **IE** Field Basic

reliable basic performance and advanced ease-of-use!

## High Performance

### Compatible with Various Field Networks

MR-JE series is compatible with various networks including CC-Link IE Field Network Basic, SSCNET III/H, and MODBUS®.

### Fast and Accurate

The dedicated engine enables a speed frequency response of 2.0 kHz, shortening the cycle time.

### High-Resolution Encoder

The servo motor is equipped with 131072 pulses/rev (17-bit) high-resolution encoder, achieving high accuracy.

### Energy Conservation

The large capacity main circuit capacitor allows the regenerative energy to be used effectively, reducing energy consumption.

## Global Standard

### Compliance with Global Standards

Global servo, MR-JE series, complies with global standards as standard.

### Sink and Source Connections

Command pulse input and digital input/output are compatible with both sink and source type connections.

\*For MR-JE-C, command pulse input is available only with sink wiring.

### Global Support

FA Centers located throughout the world provide attentive services to support users.

# With Mitsubishi Electric's commitment to total system solutions the MELSERVO-JE becomes the answer to the world-wide

To satisfy your needs of advanced driving control systems, Mitsubishi Electric provides an extensive range of automation and servo motors to programmable controllers, Positioning modules, Human Machine Interfaces and highly developed With our global support network which provides attentive services including product purchases, after-sales services, we assure you the maximum performance of MELSERVO-JE throughout the world.

## CONTROLLER



**MELSEC iQ-F series**



**MELSEC-L series**



**MELSEC-F series**

**Simple Motion module**



**FX5\_SSC-S  
LD77MS**

**Position board**

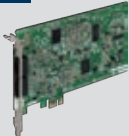

**MR-MC\_**

**Positioning module**



**FX5-20PG-P    FX3u-1PG    LD75P/D**

## INTERFACE

**SSCNET III/H**



**Pulse train, analog voltage,  
MODBUS® RTU**

## SERVO AMPLIFIER

SSCNET III/H-compatible servo amplifier



**MR-JE-B**

General-purpose interface-compatible servo amplifier



**MR-JE-A**

## SERVO MOTOR

Servo motor



**HG-KN series**  
Capacity: 100 to 750 W



**HG-SN series**  
Capacity: 0.5 to 3 kW

## LOW VOLTAGE SWITCH GEAR

## LINEUP

Servo amplifier<sup>2</sup>

● : Compatible    — : Not compatible

Model	Power supply specification <sup>1</sup>	Rated output <sup>1</sup> [kW]	Command interface					Control mode					
			SSCNET III/H	CC-Link IEF Basic	MODBUS <sup>®</sup> /TCP	MODBUS <sup>®</sup> RTU	Pulse train	Analog voltage	Position	Speed	Torque	Profile	Positioning function
MR-JE_C	3-phase 200 V AC	0.1, 0.2, 0.4, 0.75, 1, 2, 3	—	●	●	●	●	●	●	●	●	●	●
MR-JE_B	1-phase 200 V AC	0.1, 0.2, 0.4, 0.75, 1, 2, 3	●	—	—	—	—	—	●	●	●	—	—
MR-JE_A			—	—	—	—	●	●	●	●	—	●	—

<sup>1</sup>1. For servo amplifiers with a rated output of 3 kW, only 3-phase is available.

<sup>2</sup>2. This list shows the functions supported by the latest version of servo amplifiers. For version-specific functions, refer to the relevant Instruction Manual.



Easy To Use



High Performance



Global Standard

and global supports,  
needs in driving control.

products from servo amplifiers  
solutions.  
technical consulting, and practical training,

**Controller**



MELSEC iQ-R series



MELSEC Q series



Personal computer

**HUMAN  
MACHINE  
I/F**

**Graphic Operation Terminal**



GOT2000 series

**Positioning module**

**Pulse train**



RD75P/D



QD75P/D



QD70P/D

**SOFTWARE**

Programmable Controller  
Engineering Software  
MELSOFT **GX Works3**  
MELSOFT **GX Works2**

Servo Setup Software  
MELSOFT  
**MR Configurator2**

Capacity Selection Software

Pulse train, analog voltage,  
MODBUS®/TCP, MODBUS® RTU

CC-Link IE Field  
Network Basic

CC-Link IE Field Basic

Ethernet-compatible servo amplifier



MR-JE-C

**SENSING  
MODULE**

**SSCNET III/H-compatible  
sensing module**



MR-MT2000 series

**Molded-case  
circuit breaker**



WS-V

**Magnetic  
contactor**



MS-T

**SOLUTION**



e-F@ctory is the Mitsubishi Electric solution for improving the performance of any manufacturing enterprise by enhancing productivity, and reducing the maintenance and operation costs together with seamless information flow throughout the plant.



Mitsubishi Electric's integrated FA platform for achieving lateral integration of controllers & HMI, engineering environments and networks at production sites.

**Servo Motor**

● : Available

Series	Rated speed [r/min]	Maximum speed [r/min]	Rated output [kW]	With electromagnetic brake (B)	Oil seal (J)	IP rating <sup>2</sup>
HG-KN series	3000	5000 (6000) <sup>*3</sup>	0.1, 0.2, 0.4, 0.75	●	●	IP65
HG-SN series	2000	3000/2500 <sup>*1</sup>	0.5, 1, 1.5, 2, 3	●	●	IP67

\*1. The maximum speed of HG-SN302J is 2500 r/min.

\*2. The shaft-through portion is excluded.

\*3. The default speed is 5000 r/min. The speed can be set to 6000 r/min with the parameter of servo amplifiers.

Compatible with various interfaces! MR-JE-C is now available.



MR-JE-C servo amplifiers support pulse train command and Field Network.

With a single servo amplifier, you can select a suitable interface from a variety of selections to configure a system.

MELSERVO-JE **CC-Link IE Field Network Basic**

e-F@ctory with MR-JE-C

JE-C

**Ethernet-Based Open Network**

CC-Link IE Field Basic

CC-Link IE Field Network Basic realizes easier network integration, as its cyclic communications stack is software-based, without requiring a dedicated ASIC. The network operates on the standard Ethernet protocol stack, which can be used together with TCP/IP communications (such as HTTP, FTP). This feature allows CC-Link IE Field Network Basic compatible products and Ethernet-compatible products to be connected on the same Ethernet communications line, enabling a highly-flexible and low-cost system.

- [Features of CC-Link IE Field Network Basic]**
1. Small-scale network system configuration
  2. Simple setup and easy troubleshooting
  3. Combining with TCP/IP communications
  4. Wider range of connectable products

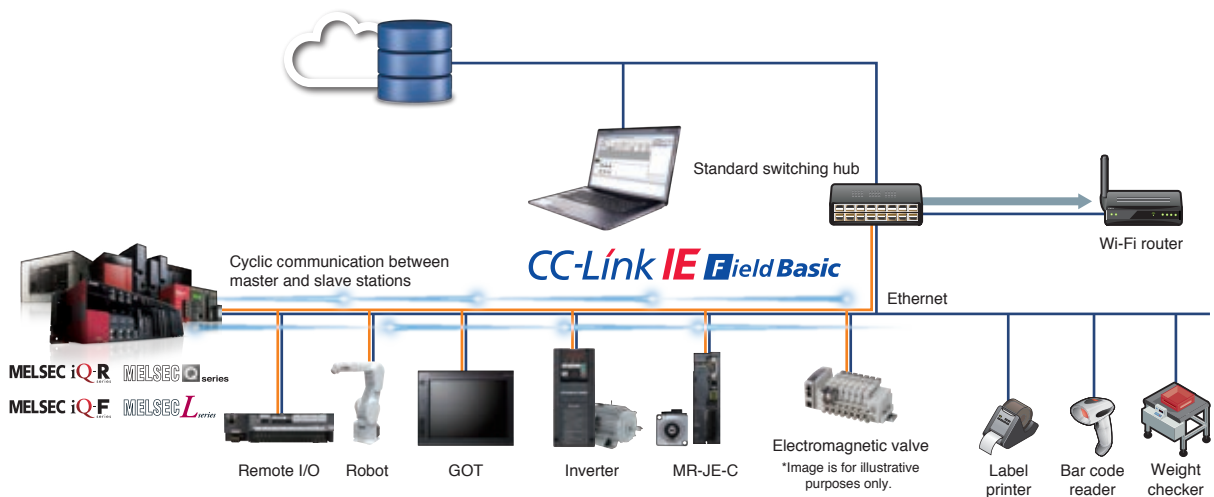



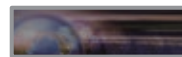

# Various Drive System Configurations

CiA 402 drive profile operation JE-C

**Profile Mode** MODBUS® CC-Link IE Field Basic

MR-JE-C servo amplifier supports CiA 402 drive profile.

- Profile position mode: pp
- Profile velocity mode: pv
- Profile torque mode: tq
- Homing mode: hm

The servo amplifier generates a command to a target position based on the target position and speed set in the master station, and starts positioning operation with a start signal.

[Continuous operation example of profile position mode]

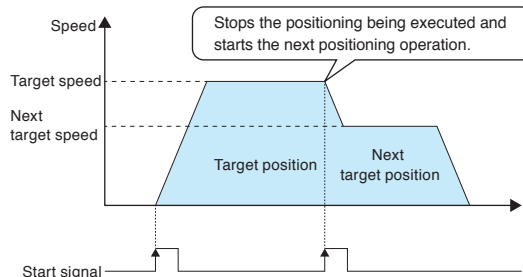

Equipped with positioning function JE-C

**Point Table Method and Indexer Method** MODBUS® CC-Link IE Field Basic

The servo amplifier performs positioning operations in point table method or indexer method without a Positioning module. With the point table method, positioning operation is started with a start signal and performed in accordance with the point table Nos. A continuous operation of the next point table is also available. With the indexer method, the travel distance is calculated automatically based on the number of equally divided stations set in the parameter. For details of the positioning function, refer to p.17 in this catalog.

\* Positioning function is supported by servo amplifiers with software version A4 or later.

Point table method

Point table No.	Point data	Servo motor speed	Acceleration time constant	Deceleration time constant	Dwell	Sub function
1	1000	2000	200	200	0	1
2	2000	1600	100	100	0	0
⋮	⋮	⋮	⋮	⋮	⋮	⋮
255	3000	3000	100	100	0	2

Operation

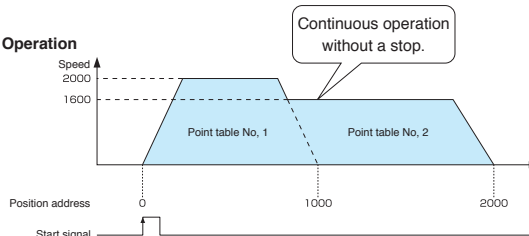

Indexer method

MR-JE-C

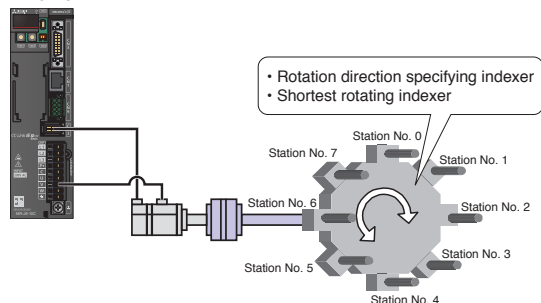

## MODBUS® network

JE-C

### MODBUS®/TCP and MODBUS® RTU

In addition to CC-Link IE Field Network Basic and SLMP, MODBUS®/TCP and MODBUS® RTU can be used to send commands from a master device to slave devices for machine operation.

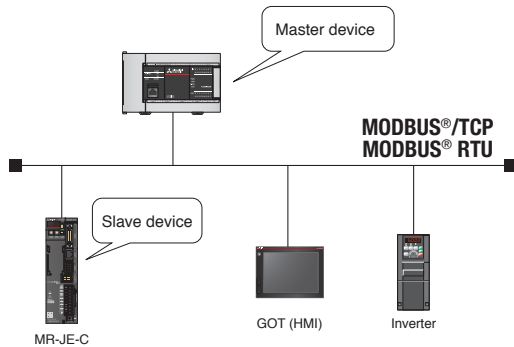

\* MODBUS® RTU is supported by servo amplifiers with software version A4 or later.

## Positioning module

JE-C

### Pulse Train/Analog Voltage Commands

MR-JE-C supports Positioning modules (both differential and open-collector types) and enables position control by pulse train command and speed/torque control by analog voltage command.

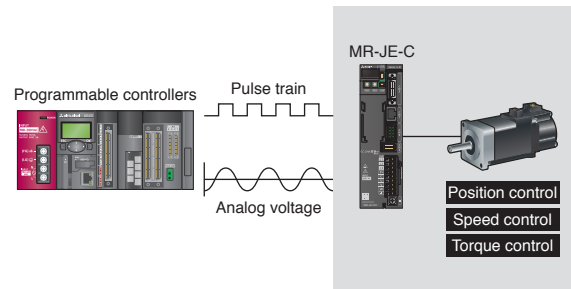

## Multi-axis operation with switching hub

JE-C

### Ethernet-Compatible Setup Software MR Configurator2

Setup software MR Configurator2 now supports Ethernet connection, and enables you to create a multi-axis project. Once a multi-axis system with MR-JE-C is set, you can easily perform adjustment or test operation of multiple axes just by changing the axis No. on a function window.

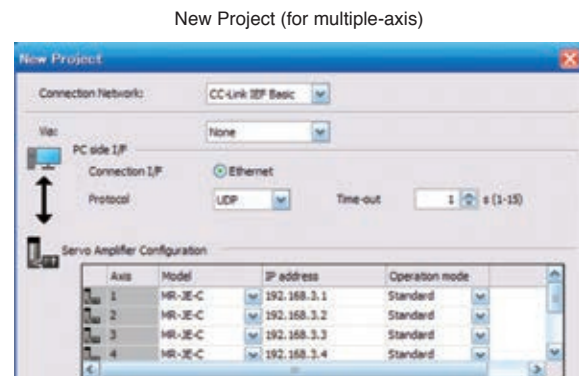

## Limiting access to the servo amplifier via Ethernet network

JE-C

### IP Address Filtering/Operation Specification IP Address Functions

The IP address filtering function limits devices accessible to the MR-JE-C, preventing unauthorized accesses such as parameter change from non-registered devices. To enable this function, register the IP address range of permitted devices. The operation specification IP address function authorize a master station (external device) to send commands to the MR-JE-C. The network devices not registered cannot send commands but can monitor operations.

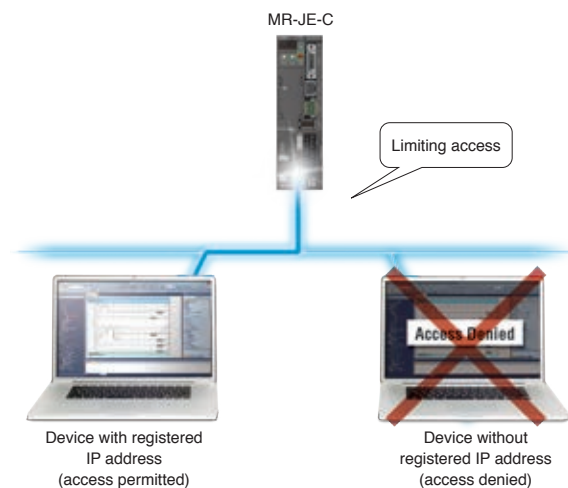



Easy To Use



High Performance



Global Standard

# MELSERIO-JE Multi-Axis System with MR-JE-C

Configuring multi-axis system easily JE-C

## Multi-Axis System CC-Link IE Field Basic

A system configured with CC-Link IE Field Network Basic has following features:

- Flexible network connection is configured easily using a switching hub.  
(Network topology: Star topology, Maximum station-to-station distance: 100 m <sup>(Note 1)</sup>)
- An FX5 CPU module alone controls multiple axes. (Up to 6 axes are connectable. <sup>(Note 2)</sup>)
- Simple synchronous operations including horizontal, vertical, and rotational movements are possible with a start signal to all axes via cyclic transmission.
- Tuning, monitoring, diagnosing, reading/writing parameters, and test operations are enabled with a personal computer (MR Configurator2) connected via Ethernet.

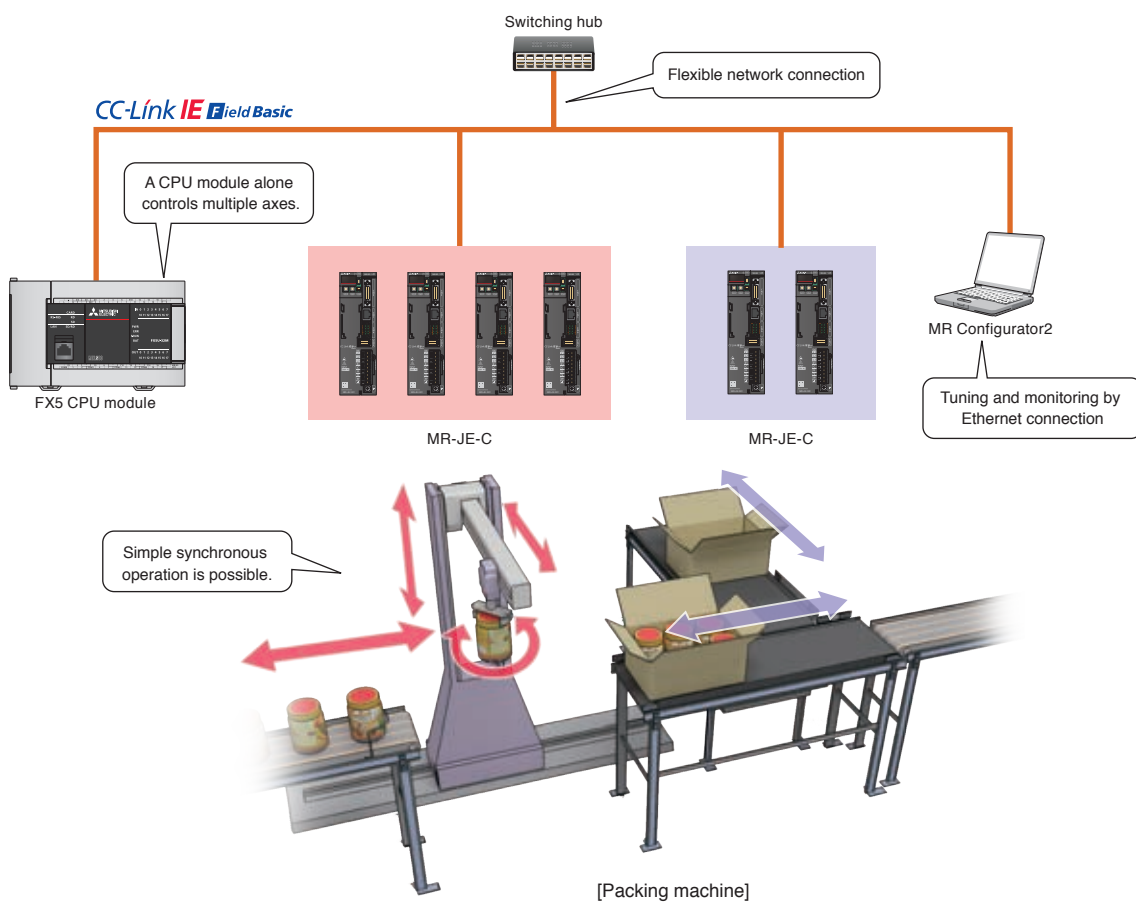

**[Application examples]**  
 Packing machines, packaging machines, material handling systems,  
 and parts assembly machines

Notes: 1. For the maximum station-to-station distance, contact manufacturers of the switching hub to be used.  
 2. For the maximum number of axes to be connected, refer to the relevant instruction manuals of the master station to be used.



# SSCNET III/H-Compatible MR-JE-B



One step forward for your machine performance

MR-JE-B is compatible with SSCNET III/H, optical servo system controller network that enables a high-response and multi-axis system with high synchronous performance and less wiring. Together with Simple Motion modules which enable various motion controls including mark detection, electronic cam and advanced synchronous control, MR-JE-B offers the performance that your application demands.

## High System Performance by SSCNET III/H

Improving system response

JE-B

### High-Speed Communication

Industry-leading levels

Communication speed has achieved 150 Mbps full duplex (equivalent to 300 Mbps half duplex).

System response is dramatically improved.

\* MR-JE-B is connectable with SSCNET III/H-compatible Simple Motion module (FX5-SSC-S, QD77MS, LD77MS, and RD77MS), Position board (MR-MC-), and C controller interface unit (Q173SCCF).

Smooth control

JE-B

### Communication Cycle of 0.444 ms

Smooth control of machine is possible using high-speed serial communication with a cycle time of 0.444 ms.

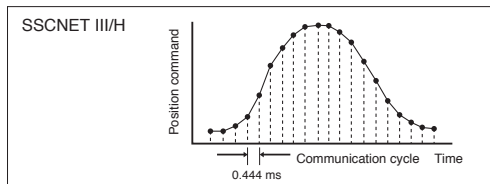

Increasing machine performance

JE-B

### Synchronous Communication

Synchronous communication is achieved with SSCNET III/H, offering technical advantages for machines in printing and food processing industry that require deterministic control.

■ Timing of servo amplifier processing

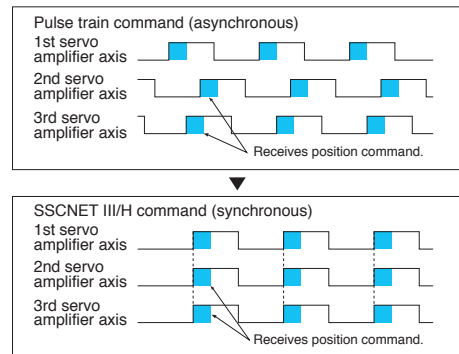

Flexible configuration

JE-B

### Network Topology

Star and line topologies are available with MR-MV200 optical hub unit through SSCNET III/H for a network configuration.

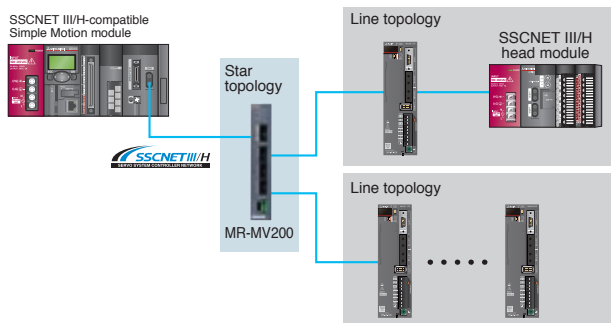

No transmission collision

JE-B

### Improved Noise Tolerance

The fiber-optic cables thoroughly shut out noise that enters from the power cable or external devices. Noise tolerance is dramatically improved as compared to metal cables.

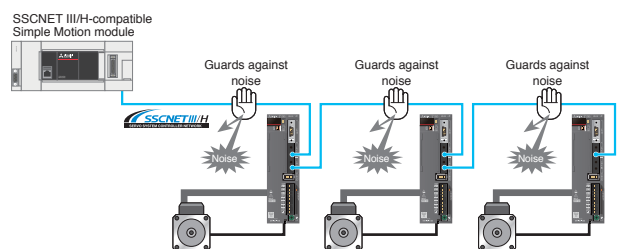

# Advanced Motion Control by Combination with Simple Motion Module

## Functions of SSCNET III/H-Compatible Simple Motion Module

Various control modes	FX5SSC	LD77MS
	QD77MS	RD77MS

### Position, Speed, Torque Control

Position, speed, and torque controls; and tightening & press-fit control are available. The position control allows to use various functions such as linear/circular interpolation control, fixed-pitch control, and target position change function. In tightening & press-fit control, the control modes between position and torque are switched smoothly.

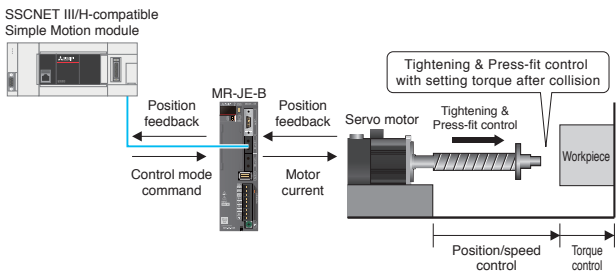

Highly flexible motion control	FX5SSC	LD77MS
	QD77MS	RD77MS

### Cam Function

Control by electronic cam is available. This function enables to create a wide variety of cam data. For example, cam data for a rotary knife can be easily created with the cam auto-generation function, increasing production efficiency.

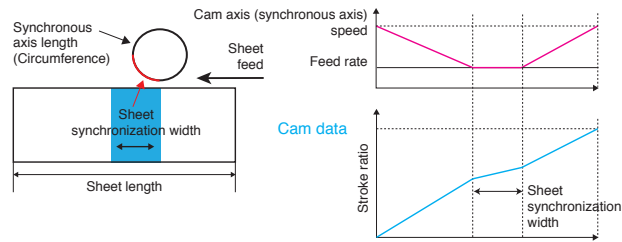

User-friendly servo adjustment	RD77MS
--------------------------------	--------

### Multi-Axis Adjustment Function

This function simultaneously adjusts parallel drive axes that are in the same motion, allowing quick setup of a machine.

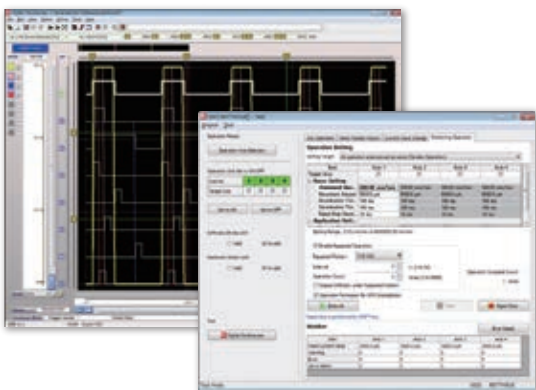

Easy position compensation	FX5SSC	LD77MS
	QD77MS	RD77MS

### Mark Detection Function

The actual position of the servo motor is obtained based on the inputs from the sensor that detects the registration marks printed on the high-speed moving film. The servo amplifier calculates compensation amounts and corrects position errors of the rotary knife axis based on those inputs from the sensor so that the film is cut at the set position.

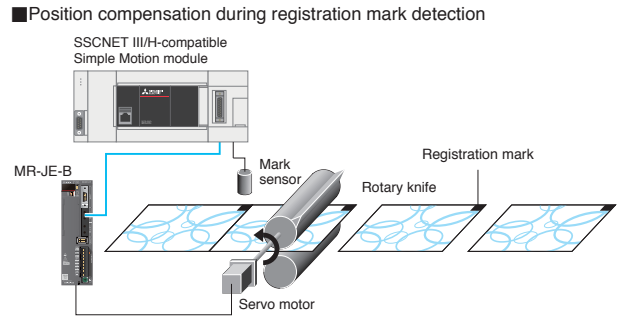

High-level synchronous control	FX5SSC	LD77MS
	QD77MS	RD77MS

### Advanced Synchronous Control

Synchronous control can be easily achieved with software by placing mechanical modules on screen, such as gears, shafts, speed change gears and cams.



Personal computer embedded type	MR-MC series
---------------------------------	--------------

### Position Board MR-MC Series

New MR-MC series, compatible with PCI Express®, PCI bus, and Compact PCI®, enables Point to Point positioning from a personal computer. Event-driven programs, which use interrupts, can be created.

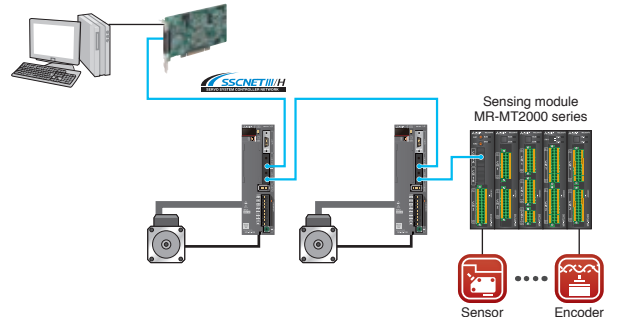

# Example of Machine Applications

JE-B	+	FX5SSC	LD77MS
		QD77MS	RD77MS

Advanced synchronous control, cam control, and mark detection function

## Packing Machines

When the machine packs food, the whole process is synchronized by using synchronous control and cam control.

The packing film is cut based on the registration marks detected by the mark detection function.

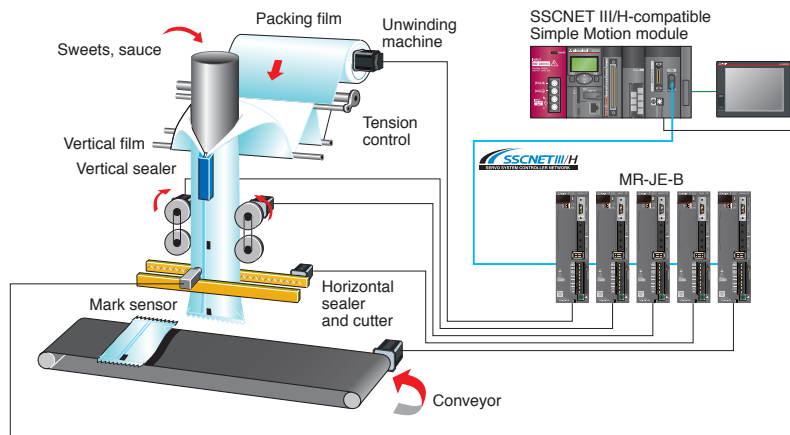

JE-B	+	FX5SSC	LD77MS
		QD77MS	RD77MS

Machine resonance suppression filter, instantaneous power failure tough drive, and lost motion compensation

## Simplified Machine Tools

In positioning operation of XY table, workpiece will be processed in high quality by using machine resonance suppression filter that suppresses machine vibration and lost motion compensation function that suppresses quadrant protrusion.

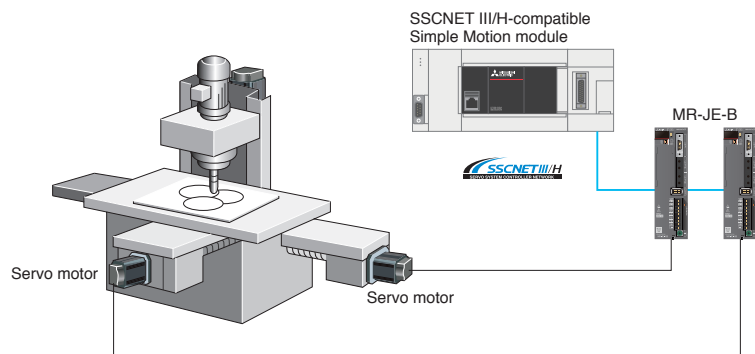

JE-B	+	FX5SSC	LD77MS
		QD77MS	RD77MS

Multi-axis synchronous control, tightening & press-fit control, machine resonance suppression filter

## Cap Tightening Machines

Position control can be switched to torque control and vice versa. "Tightening & press-fit control" is also available, switching to torque control without stopping the servo motor during the positioning operation. Since the current position is controlled in any control modes, the positioning is carried out smoothly even after switching back to the position control.

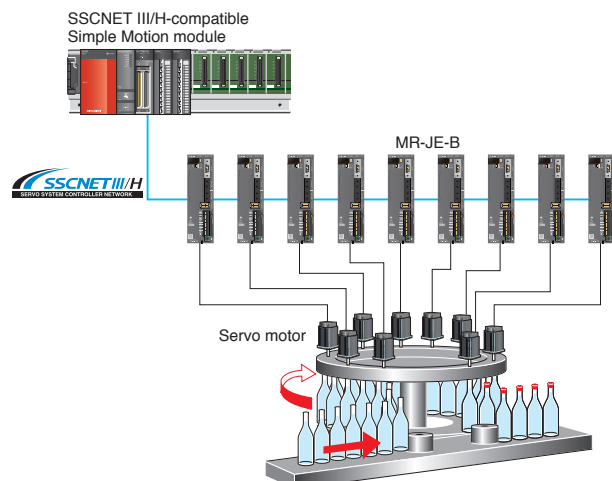



JE-B	+	FX5SSC	LD77MS
		QD77MS	RD77MS

One-touch tuning, advanced vibration suppression control II, and cam control

## Robot Material Handling

Servo gains are easily adjusted by using one-touch tuning function. In addition, the advanced vibration suppression control II suppresses low-frequency vibration of a robot hand, resulting in shorter settling time and machine cycle time.

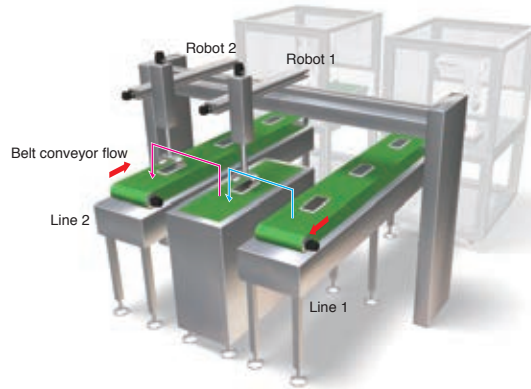

JE-B	+	FX5SSC	LD77MS
		QD77MS	RD77MS

Multi-axis synchronous control, speed/torque control, and robust filter

## Unwinders & Rewinders

SSCNET III/H allows to configure a multi-axis synchronous control system even for unwinders & rewinders with multiple axes. For machines with a machining axis, further high-level synchronous control system is possible by using cam control and advanced synchronous control. The current position of a servo motor is monitored even during speed or torque control, enabling positioning with an absolute position coordinate when the control mode is switched from speed or torque to position.

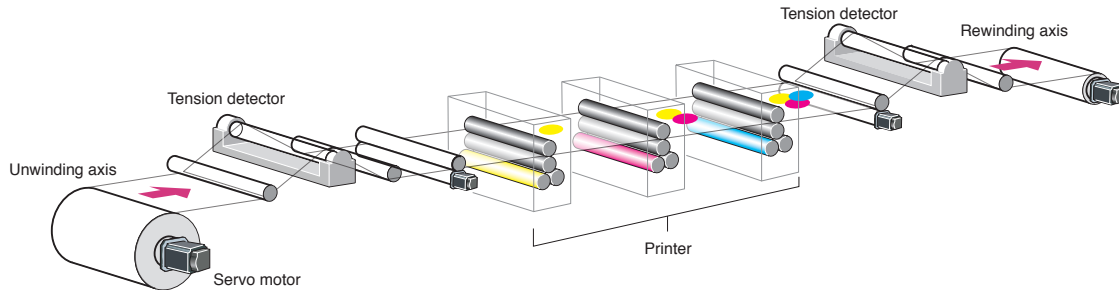

JE-B	+	FX5SSC	LD77MS
		QD77MS	RD77MS

Machine resonance suppression filter, advanced vibration suppression control II, and high-resolution encoder

## Testing System

Application of machine resonance suppression filters enables high-gain control and high-speed operation patterns. In addition, advanced vibration suppression control II suppresses vibrations of a hand and an inspection camera, reducing cycle time and enabling high quality inspection.

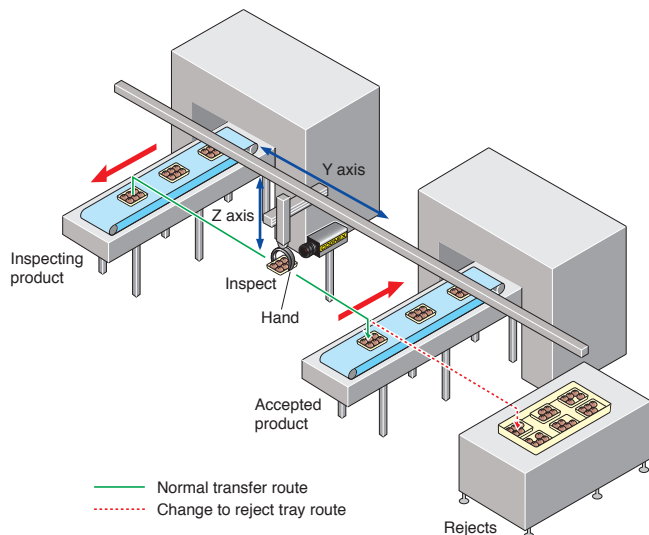

# Easy To Use

MITSUBISHI SERVO AMPLIFIERS & MOTORS  
**MELSERVO-JE**

## Fast, Trouble-Free Setup



Mitsubishi Electric's unique "One-touch tuning" enables servo gain adjustment with one-touch ease.

The increased tolerance against instantaneous power failure, the ease of maintenance, and the simple setup software would add further usability for all MELSERVO-JE users.

MELSERVO-JE

## High-Precision Tuning

Servo gain adjustment with one-touch ease

### One-Touch Tuning Function

Just turn on the one-touch tuning function to complete servo gain adjustment automatically, including machine resonance suppression filter, advanced vibration suppression control II\*, and robust filter for maximizing your machine performance.

Moreover, a new method allows to create an optimum tuning command inside the servo amplifier, further reducing adjustment time.

\* The advanced vibration suppression control II automatically adjusts one frequency.

#### MR-JE-C/MR-JE-B/MR-JE-A

Adjust the servo gain just by pressing the "Start" button on one-touch tuning window of MR Configurator2.



#### MR-JE-A

Adjust the servo gains just by pressing the buttons on the front of the servo amplifier.

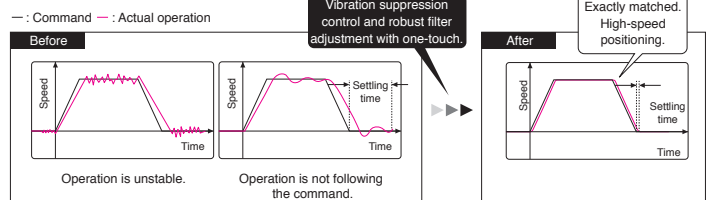
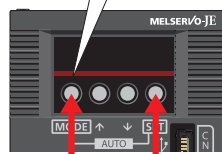

Suppressing two types of low frequency vibrations at once

### Advanced Vibration Suppression Control II

Patented

The advanced vibration suppression control II suppresses two types of low frequency vibrations, owing to vibration suppression algorithm which supports three-inertia system. This function is effective in suppressing residual vibration generated at the end of an arm and in a machine, enabling a shorter settling time. Adjustment is easily performed on MR Configurator2.

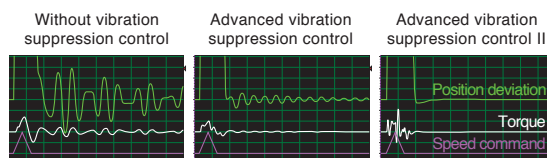
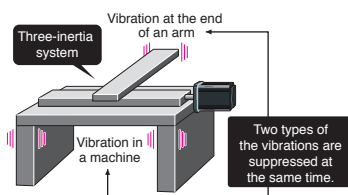



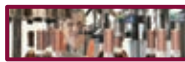

Wide frequency range

Machine Resonance Suppression Filter

With advanced filter structure, applicable frequency range is expanded to between 10 Hz and 4500 Hz. Additionally, the number of simultaneously applicable filters is increased to five, improving vibration suppression performance of a machine.

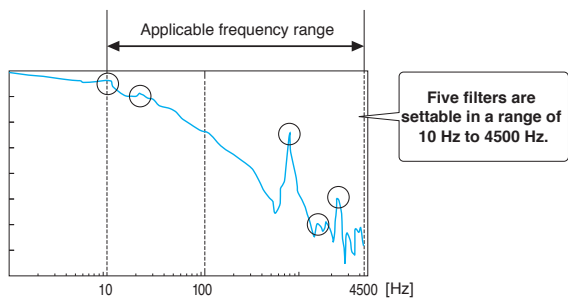

Suppressing quadrant protrusion

Lost Motion Compensation Function

This function suppresses quadrant protrusion caused by friction and torsion generated when the servo motor rotates in reverse direction. Therefore, the accuracy of circular path will be improved in trajectory control used in XY table, etc.

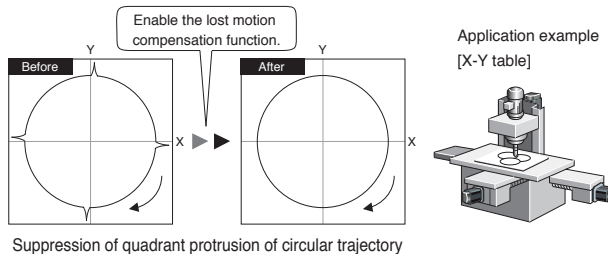

For Changes in Power Supply Environment

Reducing machine downtime

Large Capacity Main Circuit Capacitor

The capacity of main circuit capacitor is increased by 20% as compared to the previous model, increasing the tolerance against instantaneous power failure. The increased tolerance reduces machine downtime and then improves productivity.

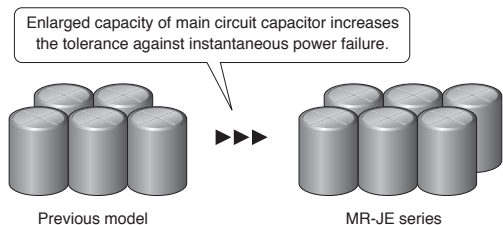

Reducing undervoltage alarms

Instantaneous Power Failure Tough Drive

When an instantaneous power failure is detected, this function allows the servo amplifier to use the electric energy charged in the main circuit capacitor in the servo amplifier to avoid an alarm occurrence, increasing the machine availability even with an unstable power supply.

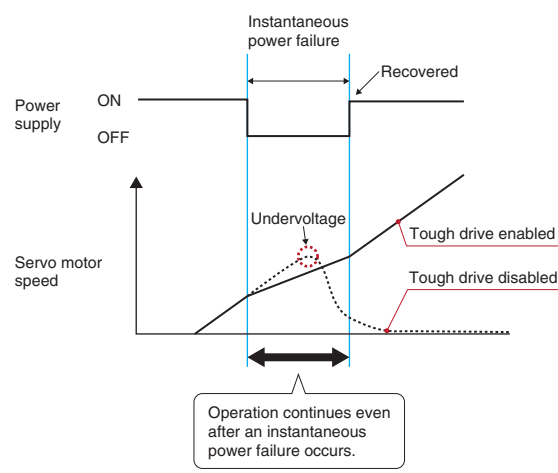

Wide power supply voltage input range

Compatible with 1-phase 200 to 240 V AC Input

Servo amplifiers of 2 kW or smaller are compatible with power supply voltage of 1-phase 200 V AC to 240 V AC.

\* When 1-phase 200 V AC to 240 V AC power supply is used with servo amplifiers of 1 kW and 2 kW, use the servo amplifiers at 75% or less of the effective load ratio. The servo amplifiers of 1 kW and 2 kW cannot be mounted closely when 1-phase power is input.

Useful Functions for Your System

Reducing machine startup time

JE-C JE-B

Absolute Position Detection System

A system using MR-JE-C/MR-JE-B lets you configure absolute detection system easily just by mounting a battery to the servo amplifiers. In the absolute detection system, home position return at the time of power-on is not necessary, shortening the machine startup time.

Compatible with various systems

MR-JE and MR-J4 in the Same System

When a servo amplifier of 3.5 kW or larger is necessary, MR-J4 series servo amplifiers can be used with MR-JE series servo amplifiers in the same system, allowing to configure various systems.

# Built-in Positioning Function

MR-JE-C and MR-JE-A, having a built-in positioning function, perform positioning operation without a Positioning module, enabling simple system configuration. MR Configurator2 allows easy setting of the positioning data.

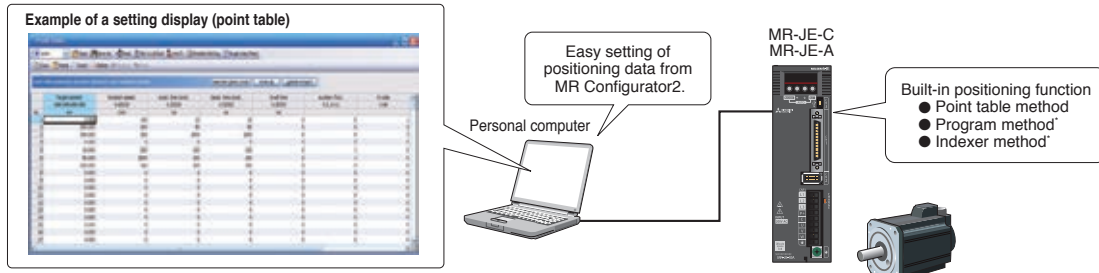

## MELSER/o-JE A Variety of Positioning Functions

Easy to set a positioning data

JE-C\* JE-A

### Point Table Method

Set position data (target position), servo motor speed, and acceleration/deceleration time constants in point table. Setting the point table data is as easy as setting parameters. Perform positioning operation with a start signal after selecting the point table Nos.

Point table example

Point table No.	Position data	Servo motor speed	Acceleration time constant	Deceleration time constant	Dwell	Sub function
1	1000	2000	200	200	0	1
2	2000	1600	100	100	0	0
⋮	⋮	⋮	⋮	⋮	⋮	⋮
n	3000	3000	100	100	0	2

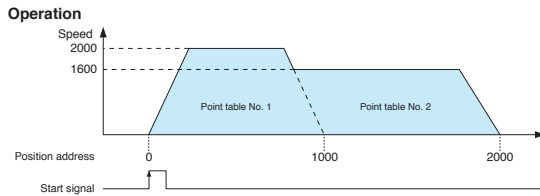

\* Point table method is supported by MR-JE-C with software version A4 or later.

Easy operation by program

JE-A

### Program Method\*

Create positioning programs with dedicated commands, and perform positioning operation with a start signal after selecting the program Nos. The program method enables more complex positioning operation than the point table method. Maximum of 16 programs are settable. (The total number of steps of program: 480)

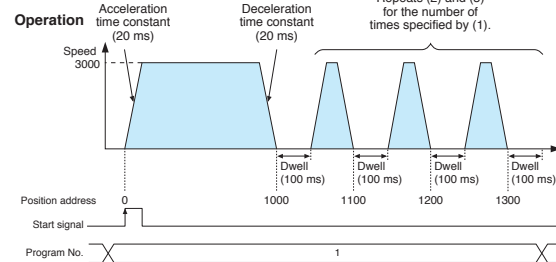
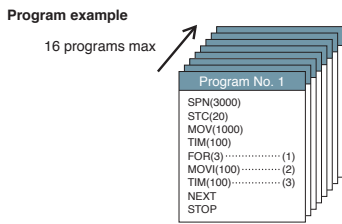

\* MR Configurator2 is required to create programs.

Automatic calculation of travel distance by setting the number of stations in parameter

JE-C\*

### Indexer Method

Perform positioning operation by specifying equally divided stations (up to 255 stations) and the number of gear teeth on machine and motor sides. The travel distance will be calculated automatically based on the number of equally divided stations set in the parameter. The positioning operation is performed with a start signal after the station position Nos. are selected.

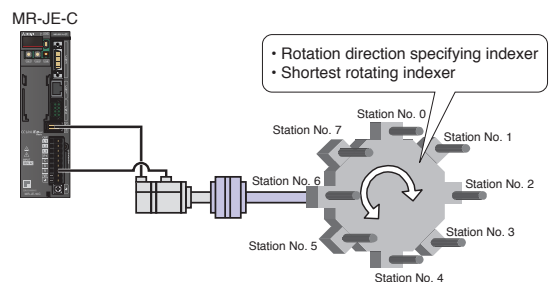

In addition to rotation direction specifying indexer and shortest rotating indexer, backlash compensation and override can be set.

\* Indexer method is supported by MR-JE-C with software version A4 or later.



Easy to create electronic cam

JE-A

### Simple Cam Function

Various patterns of cam data are created easily with MR Configurator2. Command pulse or point table/program start signal can be used as input to the simple cam. The input command will be outputted to the servo motor according to the cam data.

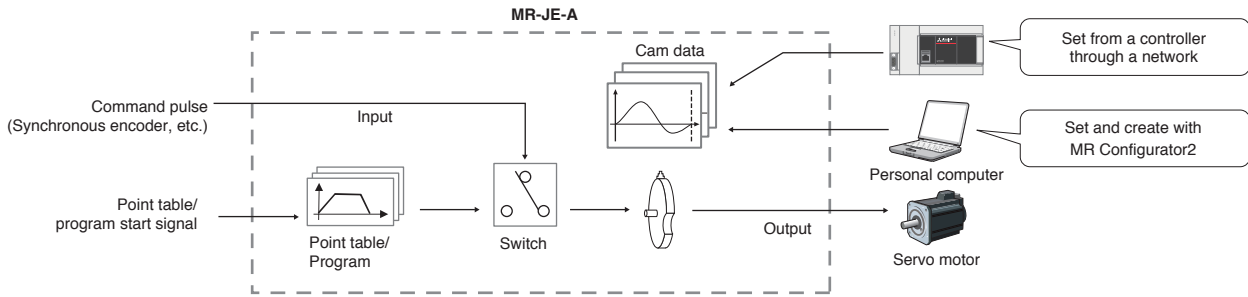

Synchronous simple operation by encoder signal input

JE-A

### Encoder Following Function/Command Pulse Input Through Function

With the encoder following function, the servo amplifier receives A/B-phase output signal from the synchronous encoder as command pulse, and the input command will be outputted to the servo motor according to the cam data. By setting cam data that matches with sheet length, a diameter of the rotary knife axis, and synchronous section of the sheet; a system in which the conveyor axis and the rotary knife axis are synchronized can be configured. Up to 4 Mpulses/s of input from synchronous encoder is compatible with the servo amplifier.

The command pulse input through function allows the first axis to output A/B-phase pulse from the synchronous encoder to the next axis, enabling a system the second and later axes are synchronized with the synchronous encoder.

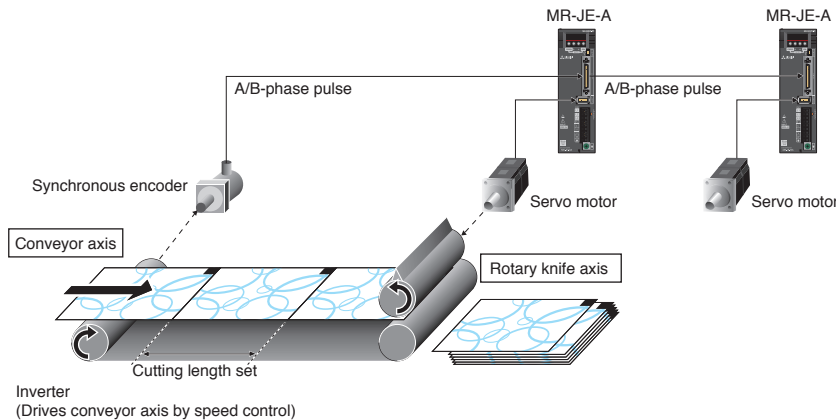

Compensating a position gap by sensor input

JE-A

### Current Position Latch Function/Interrupt Positioning Function

The actual position of the servo motor is obtained based on the inputs from the sensor that detects the registration marks printed on the high-speed moving film. The servo amplifier calculates compensation amounts and corrects position errors of the rotary knife axis based on those inputs from the sensor so that the film is cut at the set position.

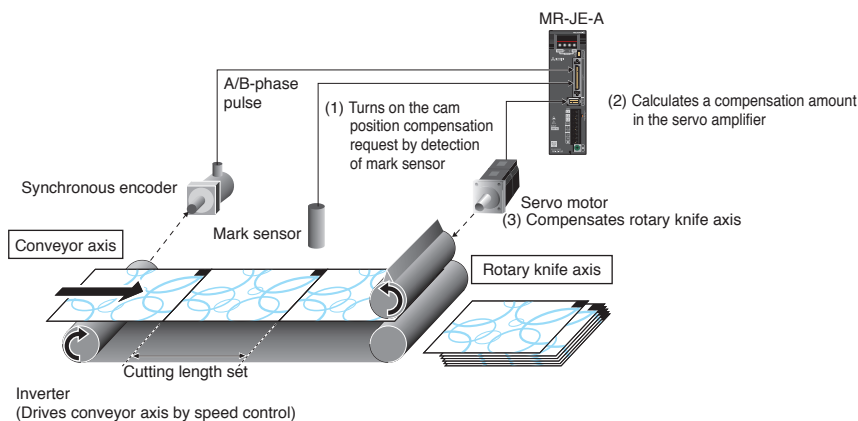

Compatible with MODBUS® protocol

JE-C JE-A

Communication Function (MODBUS® RTU and MODBUS®/TCP\*)

RS-485 (MODBUS® RTU protocol) and Ethernet (MODBUS®/TCP protocol)\* communications are supported. MODBUS® protocol is compatible with function code 03h (Read holding registers), etc. Controlling and monitoring the servo amplifier by external devices is possible.

\*MODBUS®/TCP protocol is supported by MR-JE-C

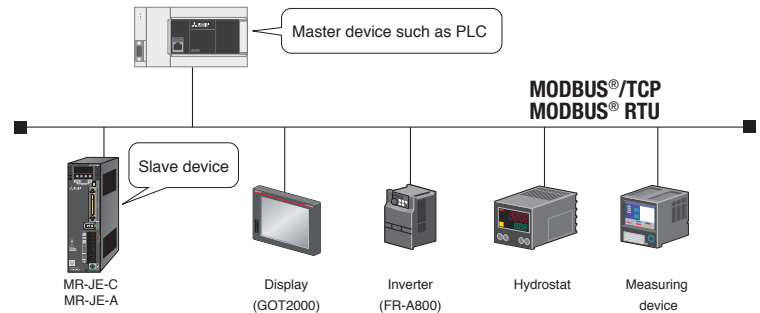

Compatible function code

03h	Read holding registers
08h	Diagnostics
10h	Preset multiple registers

Point to Point positioning

While the point table is in operation, the next target position of the point table is overwritten.

Current position latch

While the point table is in operation, the position data is latched by the current position latch function, and the function lets the controller obtain the latched data.

Analyzing cause of alarm

Large Capacity Drive Recorder

Patented

- Servo data such as motor current and position command before and after the alarm occurrence are stored in non-volatile memory of the servo amplifier. Reading the servo data on MR Configurator2 helps you analyze the cause of the alarm.
- Check the waveform ((analog 16 bits × 7 channels + digital 8 channels) × 256 points) of the past 16-time alarms in the alarm history.

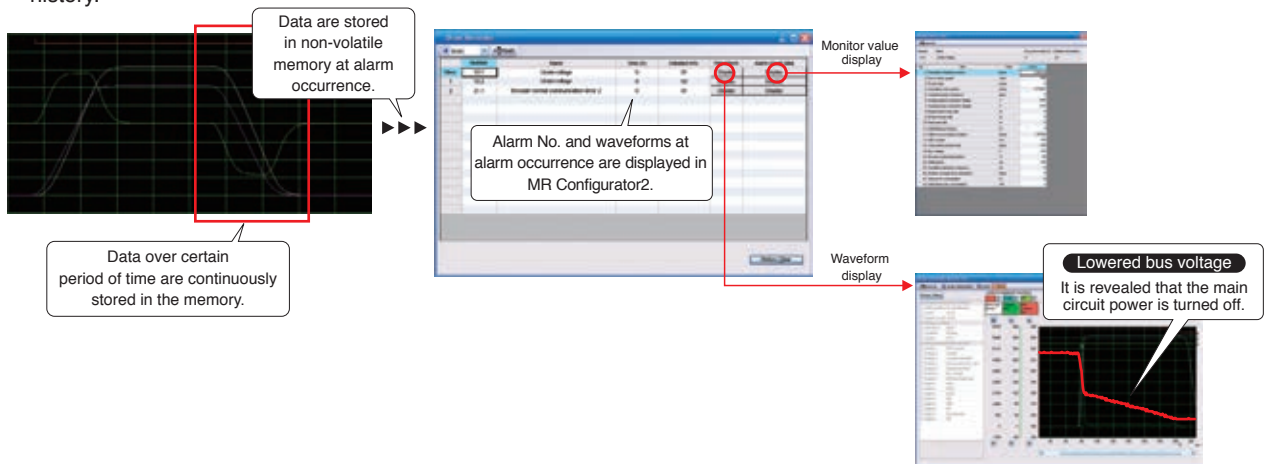

Reducing machine downtime incurred by age-related degradation

Vibration Tough Drive

Machine resonance suppression filter is automatically readjusted when a change in machine resonance frequency is detected by the servo amplifier, reducing unplanned machine downtime caused by age-related degradation.

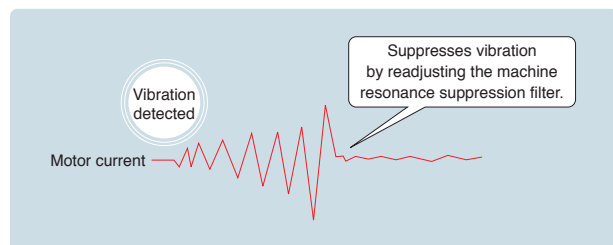

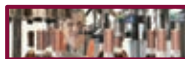

### Supporting optimal maintenance of driving parts

## Machine Diagnosis Function

Patented

This function detects changes in mechanical parts (ball screw, guide, bearing, belt, etc.) by analyzing changes in machine friction, load moment of inertia, unbalanced torque, and vibration components from the data inside a servo amplifier, supporting timely maintenance of these parts.

[Machine diagnosis function window on MR Configurator2]

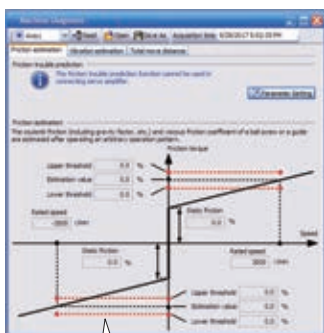

Estimated friction value is displayed.

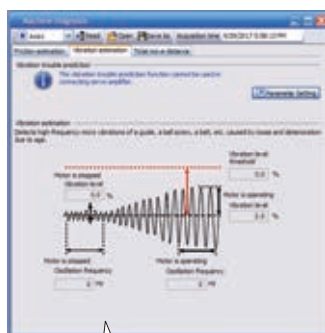

Estimated vibration value is displayed.

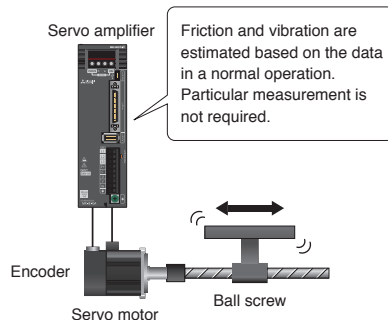

### Easy troubleshooting

## Three-Digit Alarm

MR-JE series displays the alarm No. in three digits to show the servo alarm in more details, making troubleshooting easy.

[Example of an alarm window on MR Configurator2]

[Three-digit alarm display]



This display is of MR-JE-A.

Alarm No.	Alarm Name	Cause	Check method	Check result	Action
10.1	Power supply voltage drop	<ul style="list-style-type: none"> <li>Connection to power supply connector is faulty.</li> <li>Voltage of power supply is low.</li> <li>There are air on.</li> </ul>	<ul style="list-style-type: none"> <li>Check the power supply connector.</li> <li>Check if the voltage of power supply is below 185VAC.</li> <li>Check the cover.</li> </ul>	<ul style="list-style-type: none"> <li>The program fault.</li> <li>The voltage is normal (not power supply).</li> <li>The voltage exceeds 185VAC.</li> <li>Warning sound.</li> </ul>	<ul style="list-style-type: none"> <li>Correct property.</li> <li>Check (2).</li> <li>Check (2).</li> <li>Check the cover.</li> </ul>

The alarm No. shows whether the undervoltage alarm was caused by instantaneous power failure or by lowered bus voltage in the servo amplifier.

### Even in severe environment

## Improved Environment Resistance

Ingress protection\* of servo motors:

HG-KN: IP65

HG-SN: IP67

\* The shaft-through portion is excluded.

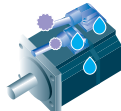

Protected from water and dust.

### Cable leading in both ways

## Selectable Cable Leading Direction

Cables for power, encoder, and electromagnetic brake are capable of being connected either in direction or in opposite direction of the load side, depending on the cable selection. (HG-KN series)

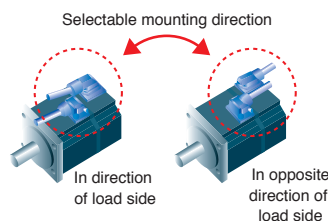

The easy-to-use MR-JE series makes startup and adjustment that simple.

Servo setup software

# MR Configurator2 (SWIDNC-MRC2-E)

Tuning, monitor display, diagnosis, reading/writing parameters, and test operations are easily performed on a personal computer.

This startup support tool achieves a stable machine system, optimum control, and short setup time.

## MELSER/o-JE Preparation

Just follow the guidance, and setup is complete

### Servo Assistant Function

Complete setting up the servo amplifier just by following guidance displays. Related functions are called up from the shortcut buttons, making it so easy to set parameters and display alarms.

So simple! Just follow the guidance.



Supporting replacement from conventional system

JE-A

### Parameter Converter Function

With this function, parameter files for MR-E series or MR-E Super series are converted to those for MR-JE-A series.

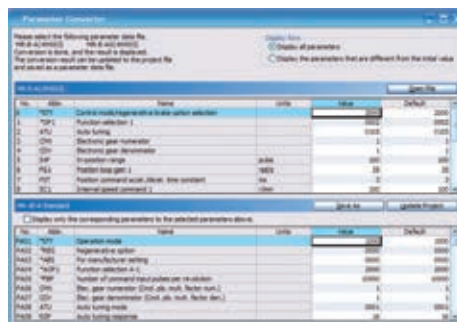

## MELSER/o-JE Setting and Startup

Easy and fast parameter setting

### Parameter Setting Function

Display parameter setting in list or visual formats, and set parameters by selecting from the drop down list. Set in-position range in mechanical system unit (e.g.  $\mu\text{m}$ ). Parameter read/write time is approximately one tenth of the conventional time.

Set without manuals.



Display details of relevant parameters in a docking window.

Visible operation and power status

### Monitor Function

Monitor operation information on the [Display all] window. The power consumption can also be monitored without additional measurement equipment. Assign input/output signals and monitor on/off status of the signals on the "I/O monitor" window.

[Display all] window

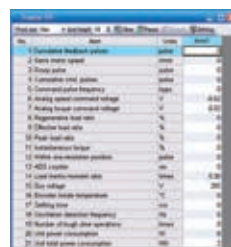

[I/O monitor] window



Monitor without measurement equipment.

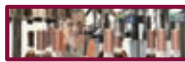

# Servo Adjustment

## Tuning is just one click away One-Touch Tuning Function

With the ease of clicking the start button, adjustments including estimating load to motor inertia ratio, adjusting gain, and suppressing machine resonance are automatically performed for the maximum servo performance. Check the adjustment results of settling time and overshoot.

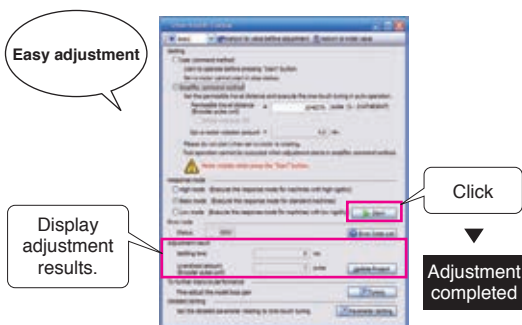

## Fine tuning of loop gain Tuning Function

Adjust control gain finely on the [Tuning] window manually for further performance after the one-touch tuning.

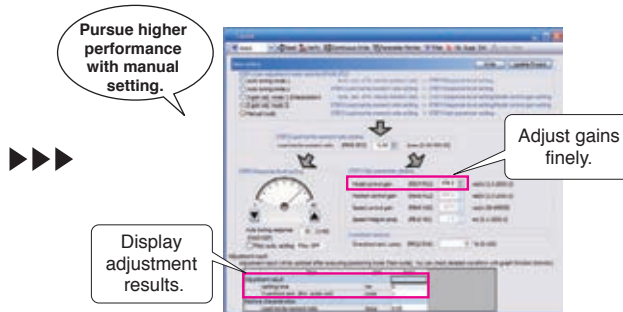

## Convenient with overwrite and graph history functions Graph Function

The number of measurement channels is increased to 7 channels for analog and 8 channels for digital. Display various servo statuses in the waveform at one measurement, supporting setting and adjustment. Convenient functions such as [Overwrite] for overwriting multiple data and [Graph history] for displaying graph history are available.



## Analyzing the frequency characteristics Machine Analyzer Function

Input random torque to the servo motor automatically and analyze frequency characteristics (0.1 Hz to 4.5 kHz) of a machine system just by clicking the [Start] button. This function supports setting of machine resonance suppression filter, etc.

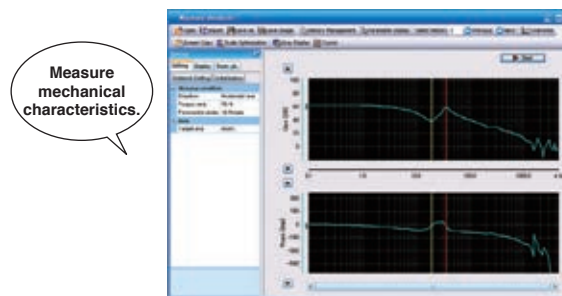

# Maintenance

## For timely parts replacement Servo Amplifier Life Diagnosis Function

Check cumulative operation time and on/off times of inrush relay. This function provides an indication of replacement time for servo amplifier parts such as capacitor and relays.

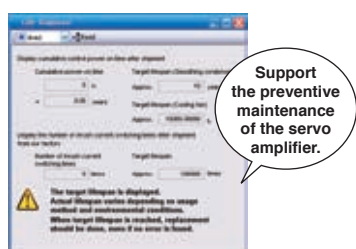

## For preventive maintenance Machine Diagnosis Function

This function estimates machine friction and vibration in normal operation without special measurements. Comparing the data of the first and after years of operations helps to find out the age-related degradation of a machine, supporting preventive maintenance.

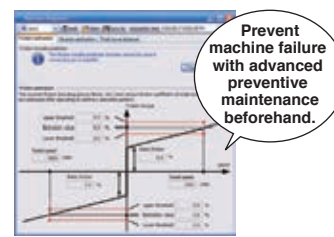

# High Performance

MITSUBISHI SERVO AMPLIFIERS & MOTORS  
**MELSERVO-JE**

## Further Reduction of Cycle Time



Top-level basic performance is achieved, including speed frequency response of 2.0 kHz. The MELSERVO-JE series that utilizes regenerative energy maximizes the machine performance and energy saving.

MELSERVO-JE

## Fast and Accurate

### Class top-level speed frequency response

#### 2.0 kHz Speed Frequency Response

The top-level speed frequency response of 2.0 kHz shortens the settling time substantially, reducing the cycle time of a machine.

[Settling time comparison with the prior model]

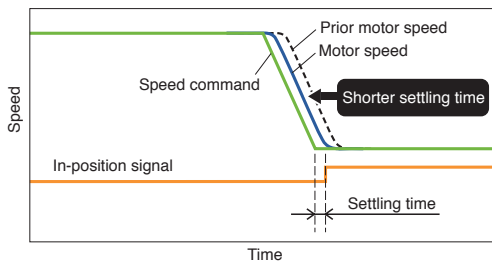

### Exact positioning

#### High-Resolution Encoder

The servo motor equipped with a high-resolution encoder\* of 131072 pulses/rev (17-bit) enables high-accuracy positioning and smooth rotation.

\* MR-JE-A does not support absolute position detection system.

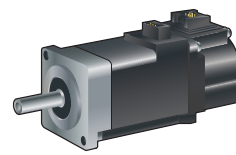

Equipped with high-resolution encoder.

### Further smooth operation

JE-C JE-A

#### Max Command Pulse Frequency of 4 Mpulses/s

MR-JE-C and MR-JE-A support the maximum command pulse frequency of 4 Mpulses/s, enabling smooth operation.

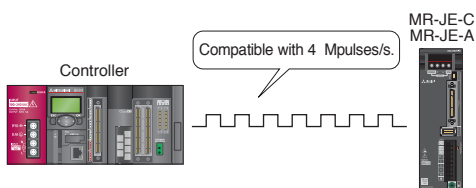

### Smooth, constant-speed operation

#### Reduced Torque Ripple during Conduction

The torque ripple is reduced owing to the optimized combination of the numbers of the motor poles and the slots, and thus enabling smooth rotation and stable operation.

#### Torque ripple

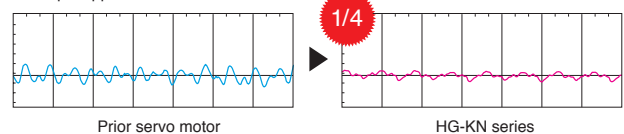



Compatible with pulse train and analog

JE-C JE-A

### Flexible Command Interface

The command interface of MR-JE-C and MR-JE-A is compatible with both pulse train command and analog voltage command, enabling position control with pulse train command, and speed and torque control with analog voltage command.

## Eco-Friendly Performance

Reducing waste in energy consumption

### Efficient Utilization of Regenerative Energy

Capacity of the main circuit capacitor is increased by 20% as compared to that of the prior model, and thus the charging capacity is increased, enabling larger regenerative energy to be reused as driving energy. Additionally, since the control circuit and the main circuit use a common power supply, the regenerative energy is also used for the control circuit, reducing waste in energy consumption.

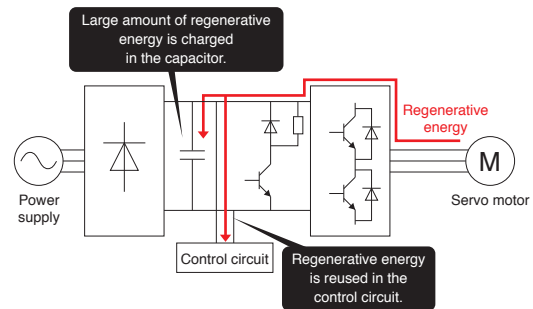

Visualizing power consumption

### Power Monitor

Driving power and regenerative power are calculated from the data in the servo amplifier such as speed and current, and the power consumption is monitored with MR Configurator2. Visualization of the power consumption helps to save energy.

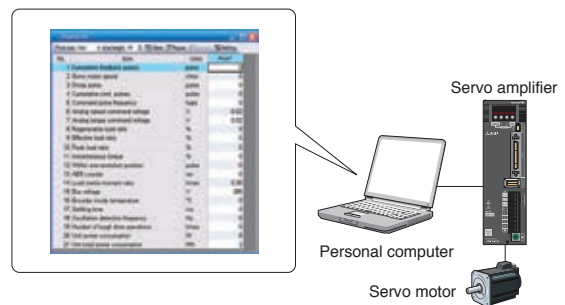

Achieving further energy saving

### Saving Energy with Advanced Technologies

#### Reducing energy loss of the servo amplifier

Efficiency is increased by the use of a new power module. Energy loss of the servo amplifier itself is reduced.



#### Saving energy by improving machine performance

The servo amplifiers and the servo motors with the industry-leading level of high performance reduce machine cycle time and operation time, resulting in less energy consumption.

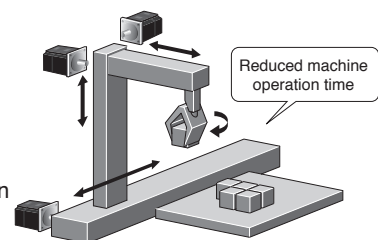

# Global Standard

MITSUBISHI SERVO AMPLIFIERS & MOTORS  
**MELSERVO-JE**



## Fully Compliant Worldwide

To satisfy growing needs in driving control throughout the world, the MR-JE series complies with global standards.

Command pulse input and digital input/output are compatible with both sink and source type connections.

MELSERVO-JE

## Global Servo Meets Global Standards

Best quality all over the world

### Compliance with Global Standards and Regulations

Use the MR-JE series globally. The servo amplifiers and the servo motors comply with global standards as standard.

#### Compliance with global standards and regulations



		Servo amplifier	Servo motor
Europe (EC)	Low voltage directive	EN 61800-5-1	EN 60034-1
	EMC directive	EN 61800-3 Category C3	
	RoHS directive	EN 50581	
North America	UL standard	UL 508C	UL 1004-1 / UL 1004-6
	CSA standard	CSA C22.2 No.14	CSA C22.2 No.100
	China	GB 12668.501, GB 12668.3	GB 755
China	National Standard of the People's Republic of China (GB standards)	Compliant (Article 13 (Names and the content of hazardous substances are described in Instruction Manuals.))	
	Management Methods for the Restriction of the Use of Hazardous Substances in Electrical and Electronic Products (Chinese RoHS)	Compliant (Article 14 (Marking for the Restricted Use of Hazardous Substances is labeled.))	
	China Compulsory Certification (CCC)	N/A	
Korea	Korea Radio Wave Law (KC)	KN 61800-3	N/A
Russia, Belarus, Kazakhstan	Certification system of the Eurasian Economic Union (EAC)	TR CU 004, TR CU 020	

### Flexible connections for the global use

#### Sink and Source Connections

Command pulse input and digital input/output are compatible with both sink and source type connections, allowing more flexible system configuration.

\* For MR-JE-C, command pulse input is available only with sink wiring when open-collector wiring is used.

#### Example of digital input

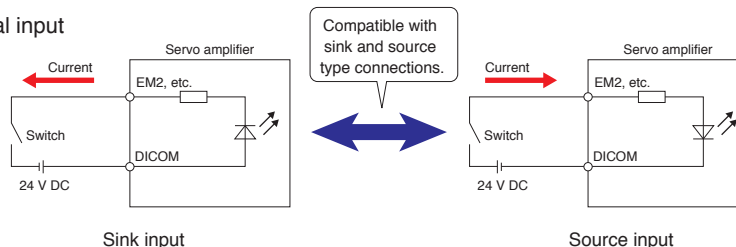



**MELSERVO-JE** Extensive Global Support Network

Supporting MELSERVO users worldwide

**Global FA Centers**

Through our global service network, Mitsubishi Electric offers extensive support and expert help to our customers for their advanced, optimal manufacturing.

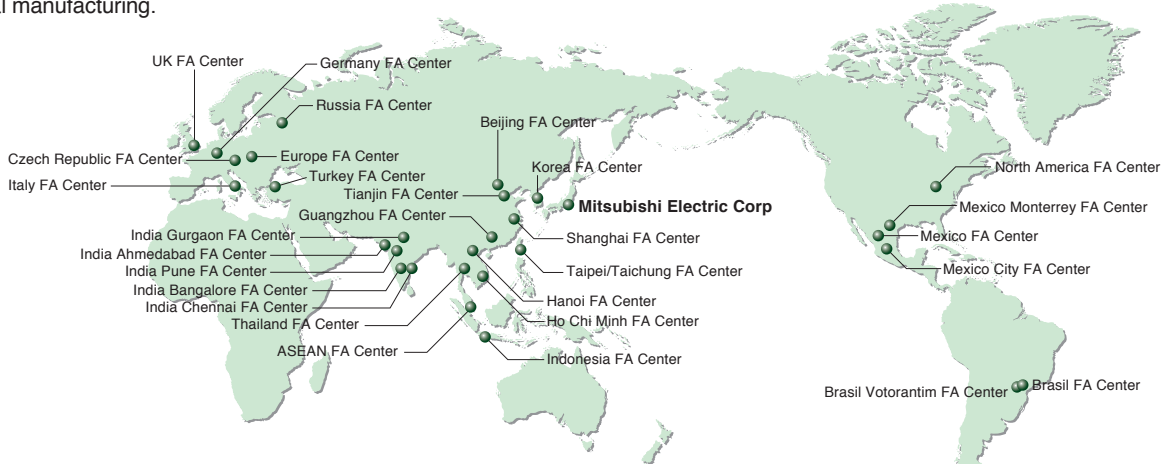

**Shanghai, China**  
Shanghai FA Center



**Seoul, Korea**  
Korea FA Center



**Pune/Gurgaon/Bangalore/Chennai/Ahmadabad, India**  
India FA Center



**Ratingen, Germany**  
Germany FA Center



**Beijing, China**  
Beijing FA Center



**Bangkok, Thailand**  
Thailand FA Center



**Chicago IL, U.S.A.**  
North America FA Center



**Hatfield, U.K.**  
UK FA Center



**Tianjin, China**  
Tianjin FA Center



**Singapore**  
ASEAN FA Center



**Tlalnepantla Edo./Queretaro/ Monterrey, Mexico**  
Mexico FA Center



**Praha, Czech Republic**  
Czech Republic FA Center



**Guangzhou, China**  
Guangzhou FA Center



**Bekasi, Indonesia**  
Indonesia FA Center



**Barueri SP/Votorantim SP, Brazil**  
Brazil FA Center



**Milano, Italy**  
Italy FA Center



**Taipei/Taichung, Taiwan**  
Left: Taipei FA Center/  
Right: Taichung FA Center



**Hanoi/Ho Chi Minh, Vietnam**  
Left: Hanoi FA Center/  
Right: Ho Chi Minh FA Center



**Krakowska, Poland**  
Europe FA Center (Poland)



**St. Petersburg, Russia**  
Russia FA Center



**Istanbul, Turkey**  
Turkey FA Center

MEMO



# 1

## Servo Amplifiers

Model Designation.....	1-1
Combinations of Servo Amplifier and Servo Motor.....	1-1
MR-JE-C	
Connections with Peripheral Equipment.....	1-2
Specifications .....	1-3
Standard Wiring Diagram Example .....	1-5
Power Supply Connection Example .....	1-12
RS-485 Serial Communication Connection Example .....	1-13
Servo Motor Connection Example.....	1-14
Dimensions.....	1-15
MR-JE-B	
Connections with Peripheral Equipment.....	1-16
Specifications .....	1-17
Standard Wiring Diagram Example .....	1-18
Power Supply Connection Example .....	1-19
Dimensions.....	1-20
MR-JE-A	
Connections with Peripheral Equipment.....	1-21
Specifications .....	1-22
Standard Wiring Diagram Example .....	1-23
Power Supply Connection Example .....	1-29
RS-422 Serial Communication Connection Example .....	1-30
RS-485 Serial Communication Connection Example .....	1-30
Dimensions.....	1-31
MR-JE-C/MR-JE-A Positioning Function .....	1-32
MODBUS®/TCP, MODBUS® RTU Specifications .....	1-41
Simple Cam Specifications.....	1-43
1-phase 200 V AC Class Power Supply Input Using a Neutral Point of 3-phase 400 V AC Class Power Supply.....	1-44

# Servo Amplifiers

## Model Designation

C B A

MR-JE-10C

Mitsubishi Electric  
general-purpose  
AC servo amplifier  
MELSERVO-JE  
Series

Symbol	Rated output [kW]
10	0.1
20	0.2
40	0.4
70	0.75
100	1
200	2
300	3

Symbol	Interface
C	Ethernet
B	SSCNET III/H
A	General-purpose

## Combinations of Servo Amplifier and Servo Motor

C B A

Servo amplifier	Servo motor	
	HG-KN series	HG-SN series
MR-JE-10C, MR-JE-10B, MR-JE-10A	HG-KN13(B)J	-
MR-JE-20C, MR-JE-20B, MR-JE-20A	HG-KN23(B)J	-
MR-JE-40C, MR-JE-40B, MR-JE-40A	HG-KN43(B)J	-
MR-JE-70C, MR-JE-70B, MR-JE-70A	HG-KN73(B)J	HG-SN52(B)J
MR-JE-100C, MR-JE-100B, MR-JE-100A	-	HG-SN102(B)J
MR-JE-200C, MR-JE-200B, MR-JE-200A	-	HG-SN152(B)J, HG-SN202(B)J
MR-JE-300C, MR-JE-300B, MR-JE-300A	-	HG-SN302(B)J

**MR-JE-C Connections with Peripheral Equipment** (Note 1)

Peripheral equipment is connected to MR-JE-C as described below. Connectors, cables, options, and other necessary equipment are available so that users can set up the servo amplifier easily and start using it right away.

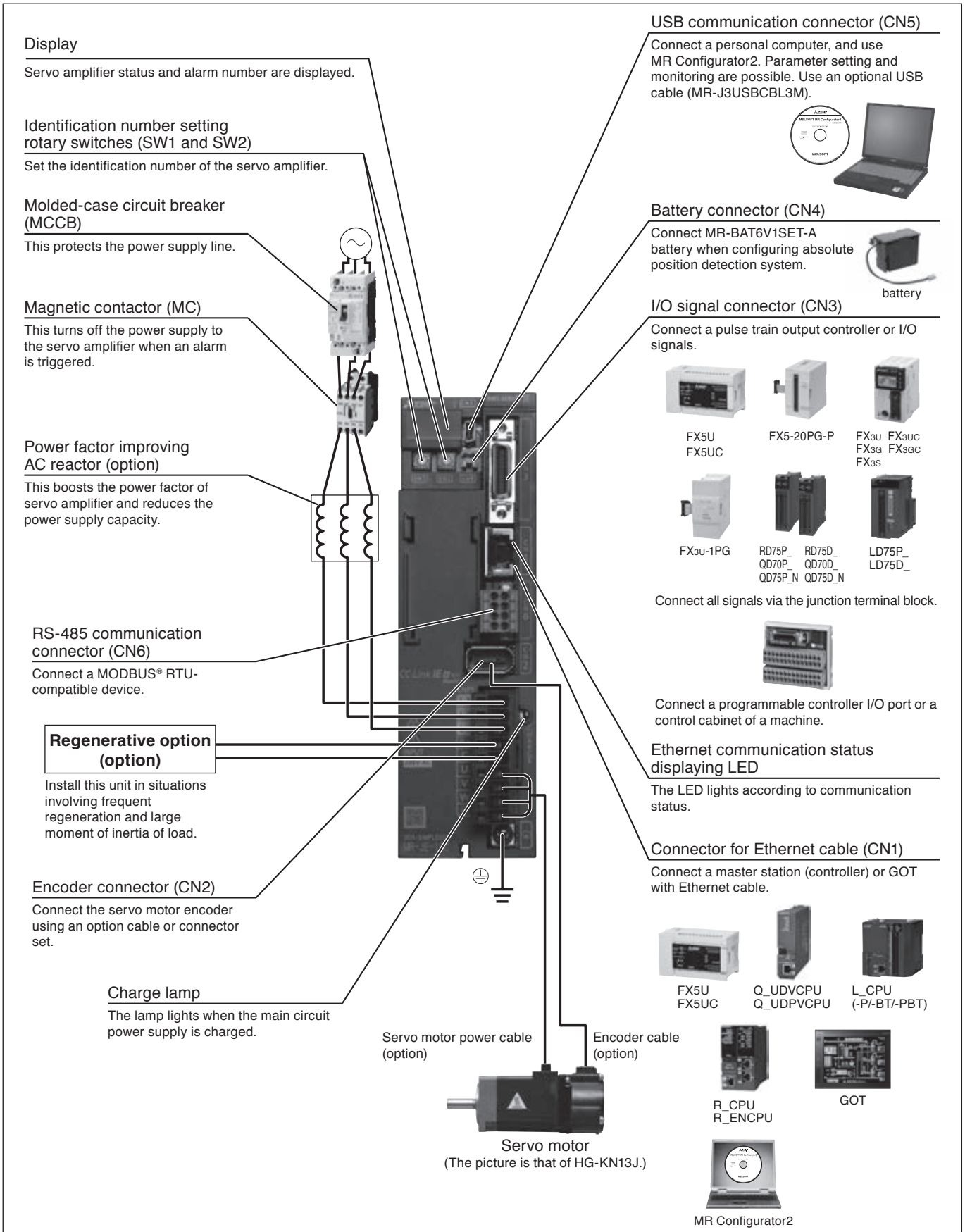

Notes: 1. The connection with the peripheral equipment is an example for MR-JE-100C or smaller servo amplifiers. Refer to "MR-JE\_C Servo Amplifier Instruction Manual" for the actual connections.

Servo Amplifiers

Servo Motors

Options/Peripheral Equipment

LVS/Wires

Product List

Cautions

## MR-JE-C (Ethernet Interface) Specifications

C

Servo amplifier model MR-JE-		10C	20C	40C	70C	100C	200C	300C	
Output	Rated voltage	3-phase 170 V AC							
	Rated current [A]	1.1	1.5	2.8	5.8	6.0	11.0	11.0	
Power supply input	Voltage/frequency (Note 1)	3-phase or 1-phase 200 V AC to 240 V AC, 50 Hz/60 Hz				3-phase or 1-phase 200 V AC to 240 V AC, 50 Hz/60 Hz (Note 7)		3-phase 200 V AC to 240 V AC, 50 Hz/60 Hz	
	Rated current (Note 6) [A]	0.9	1.5	2.6	3.8	5.0	10.5	14.0	
	Permissible voltage fluctuation	3-phase or 1-phase 170 V AC to 264 V AC				3-phase or 1-phase 170 V AC to 264 V AC (Note 7)		3-phase 170 V AC to 264 V AC	
	Permissible frequency fluctuation	±5% maximum							
Interface power supply		24 V DC ± 10% (required current capacity: 0.3 A)							
Control method		Sine-wave PWM control/current control method							
Permissible regenerative power of the built-in regenerative resistor (Note 2, 3) [W]		-	-	10	20	20	100	100	
Dynamic Brake (Note 4)		Built-in							
Communication function	Ethernet (Note 8)	Connect a master station (controller), etc.							
	USB	Connect a personal computer (MR Configurator2 compatible)							
	RS-485 (Note 11)	Connect a master station (controller), etc. (1:n communication up to 32 axes)							
Encoder output pulse		Compatible (A/B/Z-phase pulse)							
Position control mode	Maximum input pulse frequency	4 Mpulses/s (when using differential receiver), 200 kpulses/s (when using open-collector)							
	Positioning feedback pulse	Encoder resolution: 131072 pulses/rev							
	Command pulse multiplying factor	Electronic gear A/B multiple, A: 1 to 16777215, B: 1 to 16777215, 1/10 < A/B < 4000							
	In-position range setting	0 pulse to ±65535 pulses (command pulse unit)							
	Error excessive	±3 rotations							
	Torque limit	Set by parameters or external analog input (0 V DC to +10 V DC/maximum torque)							
Speed control mode	Speed control range	Analog speed command 1:2000, internal speed command 1:5000							
	Analog speed command input	0 V DC to ±10 V DC/rated speed (Speed at 10 V is changeable with [Pr. PC12].)							
	Speed fluctuation rate	±0.01% maximum (load fluctuation: 0% to 100%), 0% (power fluctuation: ±10%) ±0.2% maximum (ambient temperature: 25 °C ± 10 °C) only when using analog speed command							
	Torque limit	Set by parameters or external analog input (0 V DC to +10 V DC/maximum torque)							
Torque control mode	Analog torque command input	0 V DC to ±8 V DC/maximum torque (input impedance: 10 kΩ to 12 kΩ)							
	Speed limit	Set by parameters							
Profile mode	Profile position mode	Command position range	Set by object/register Setting range of feed length: -999999 to 999999 [pulse], Setting range of rotation angle: -360.000 to 360.000 [degree]						
		Command multiplying factor	Electronic gear A/B multiple, A: 1 to 16777215, B: 1 to 16777215, 1/27649 < A/B < 8484						
		In-position range setting	0 pulse to ±65535 pulses (command pulse unit)						
		Error excessive	±3 rotations						
	Profile velocity mode	Torque limit	Set by parameters, or object/register						
		Command speed range	-21474836.48 r/min to 21474836.47 r/min (Fixed to the permissible speed)						
	Profile torque mode	Torque limit	Set by parameters, or object/register (Fixed to the maximum torque)						
		Command torque range	-3276.8% to 3276.7% (Fixed to the maximum torque)						
Homing mode	Speed limit	Set by parameters, or object/register (Fixed to the permissible speed)							
	Mitsubishi Electric original method	Dog type, count type, data set type, stopper type, home position ignorance (servo-on position as home position), dog type rear end reference, count type front end reference, dog cradle type, dog type adjacent Z-phase reference, dog type front end reference, dogless Z-phase reference							
	CiA 402 method	Homing on positive home switch and index pulse (method 3, 4), Homing on negative home switch and index pulse (method 5, 6), Homing on home switch and index pulse (method 7, 8, 11, 12), Homing without index pulse (method 19, 20, 21, 22, 23, 24, 27, 28), Homing on index pulse (method 33, 34), Homing on current position (method 35, 37)							



MR-JE-C (Ethernet Interface) Specifications

C

Servo amplifier model MR-JE-		10C	20C	40C	70C	100C	200C	300C
Positioning mode <small>(Note 10)</small>		Point table method, indexer method						
Servo functions		Advanced vibration suppression control II, adaptive filter II, robust filter, auto tuning, one-touch tuning, tough drive function, drive recorder function, machine diagnosis function, power monitoring function, lost motion compensation function						
Protective functions		Overcurrent shut-off, regenerative overvoltage shut-off, overload shut-off (electronic thermal), servo motor overheat protection, encoder error protection, regenerative error protection, undervoltage protection, instantaneous power failure protection, overspeed protection, error excessive protection						
Compliance with global standards		Refer to "Compliance with Global Standards and Regulations" on p. 25 in this catalog.						
Structure (IP rating)		Natural cooling, open (IP20)					Force cooling, open (IP20)	
Close mounting <small>(Note 5)</small>	3-phase power supply input	Possible						
	1-phase power supply input	Possible			Not possible		-	
Environment	Ambient temperature	Operation: 0 °C to 55 °C (non-freezing), storage: -20 °C to 65 °C (non-freezing)						
	Ambient humidity	Operation/storage: 5 %RH to 90 %RH (non-condensing)						
	Ambience	Indoors (no direct sunlight); no corrosive gas, inflammable gas, oil mist or dust						
	Altitude	2000 m or less above sea level <small>(Note 9)</small>						
	Vibration resistance	5.9 m/s <sup>2</sup> at 10 Hz to 55 Hz (directions of X, Y, and Z axes)						
Mass [kg]		0.8	0.8	0.8	1.5	1.5	2.1	2.1

- Notes: 1. Rated output and speed of a servo motor are applicable when the servo amplifier is operated within the specified power supply voltage and frequency.  
 2. Select the most suitable regenerative option for your system with our capacity selection software.  
 3. Refer to "Regenerative Option" in this catalog for the permissible regenerative power [W] when a regenerative option is used.  
 4. When using the dynamic brake, refer to "MR-JE-C Servo Amplifier Instruction Manual" for the permissible load to motor inertia ratio.  
 5. When the servo amplifiers are closely mounted, keep the ambient temperature within 0 °C to 45 °C, or use the servo amplifiers at 75% or less of the effective load ratio.  
 6. This value is applicable when a 3-phase power supply is used.  
 7. When a 1-phase 200 V AC to 240 V AC power supply is used, use the servo amplifiers at 75% or less of the effective load ratio.  
 8. CC-Link IE Field Network Basic, SLMP, and MODBUS<sup>®</sup>/TCP are supported. MR Configurator2 is also connectable. MODBUS<sup>®</sup>/TCP and MR Configurator2 are supported by the servo amplifiers with software version A3 or later. Use MR Configurator2 with software version 1.68W or later.  
 9. Refer to "MR-JE-C Servo Amplifier Instruction Manual" for the restrictions when using the servo amplifiers at altitude exceeding 1000 m and up to 2000 m above sea level.  
 10. Positioning mode is supported by servo amplifiers with software version A4 or later.  
 11. MODBUS<sup>®</sup> RTU is supported by the servo amplifiers with software version A4 or later.

Servo Amplifiers

Servo Motors

Options/Peripheral Equipment

LVS/Wires

Product List

Cautions

## MR-JE-C Standard Wiring Diagram Example: Position Control Operation

C

### Connecting to FX5U-\_\_MT/ES

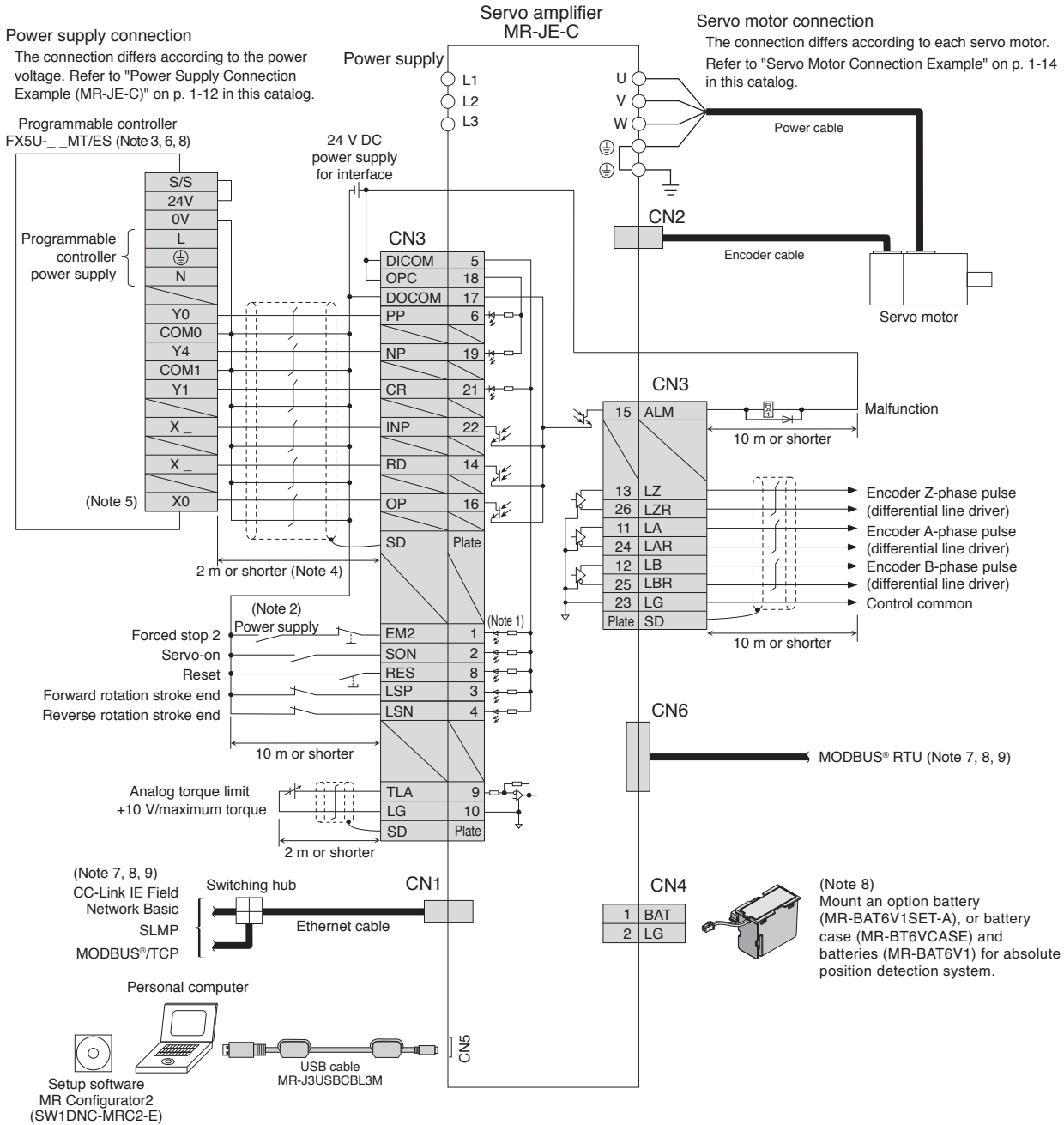

- Notes:
1. Only sink wiring is supported.
  2. To prevent an unexpected restart of the servo amplifier, create a circuit to turn off EM2 (Forced stop 2) when the power is turned off.
  3. Select the number of input/output points of the programmable controller according to your system.
  4. It is recommended that the connection be 2 m or shorter because an open-collector system is used.
  5. Select from the range of X0 to X7.
  6. For details such as setting the controllers, refer to programming manual or user's manual for the controllers.
  7. Refer to "MR-JE- C Servo Amplifier Instruction Manual (Network)" for communication functions.
  8. When absolute position detection system is used, absolute position data is read with a communication function. Refer to "MR-JE- C Servo Amplifier Instruction Manual" for absolute position detection system.
  9. Ethernet (CC-Link IE Field Network Basic, SLMP, MODBUS®/TCP) and RS-485 (MODBUS® RTU) communication functions are mutually exclusive. Only a communication function selected in [Pr. PN08] can be used.



Be sure to read through Instruction Manual for the actual wiring and use. Use the equipment after you have a full knowledge of the equipment, safety information and instructions.

MR-JE-C Standard Wiring Diagram Example: Position Control Operation

Connecting to QD75D/LD75D/RD75D

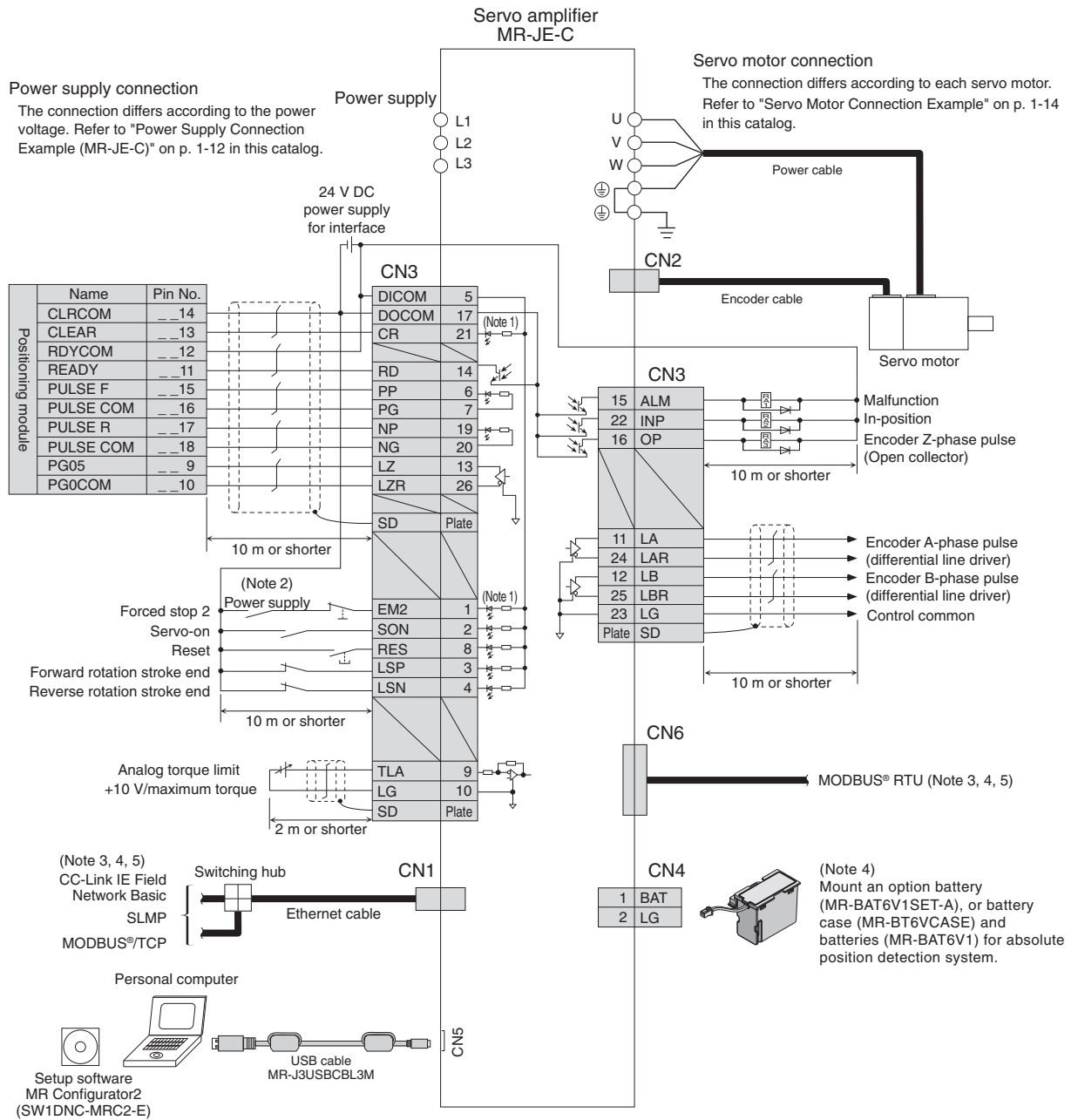

- Notes: 1. This is for sink wiring. Source wiring is also possible.  
 2. To prevent an unexpected restart of the servo amplifier, create a circuit to turn off EM2 (Forced stop 2) when the power is turned off.  
 3. Refer to "MR-JE-C Servo Amplifier Instruction Manual (Network)" for communication functions.  
 4. When absolute position detection system is used, absolute position data is read with a communication function. Refer to "MR-JE-C Servo Amplifier Instruction Manual" for absolute position detection system.  
 5. Ethernet (CC-Link IE Field Network Basic, SLMP, MODBUS®/TCP) and RS-485 (MODBUS® RTU) communication functions are mutually exclusive. Only a communication function selected in [Pr. PN08] can be used.

**!** Be sure to read through Instruction Manual for the actual wiring and use. Use the equipment after you have a full knowledge of the equipment, safety information and instructions.

## MR-JE-C Standard Wiring Diagram Example: Speed Control Operation

C

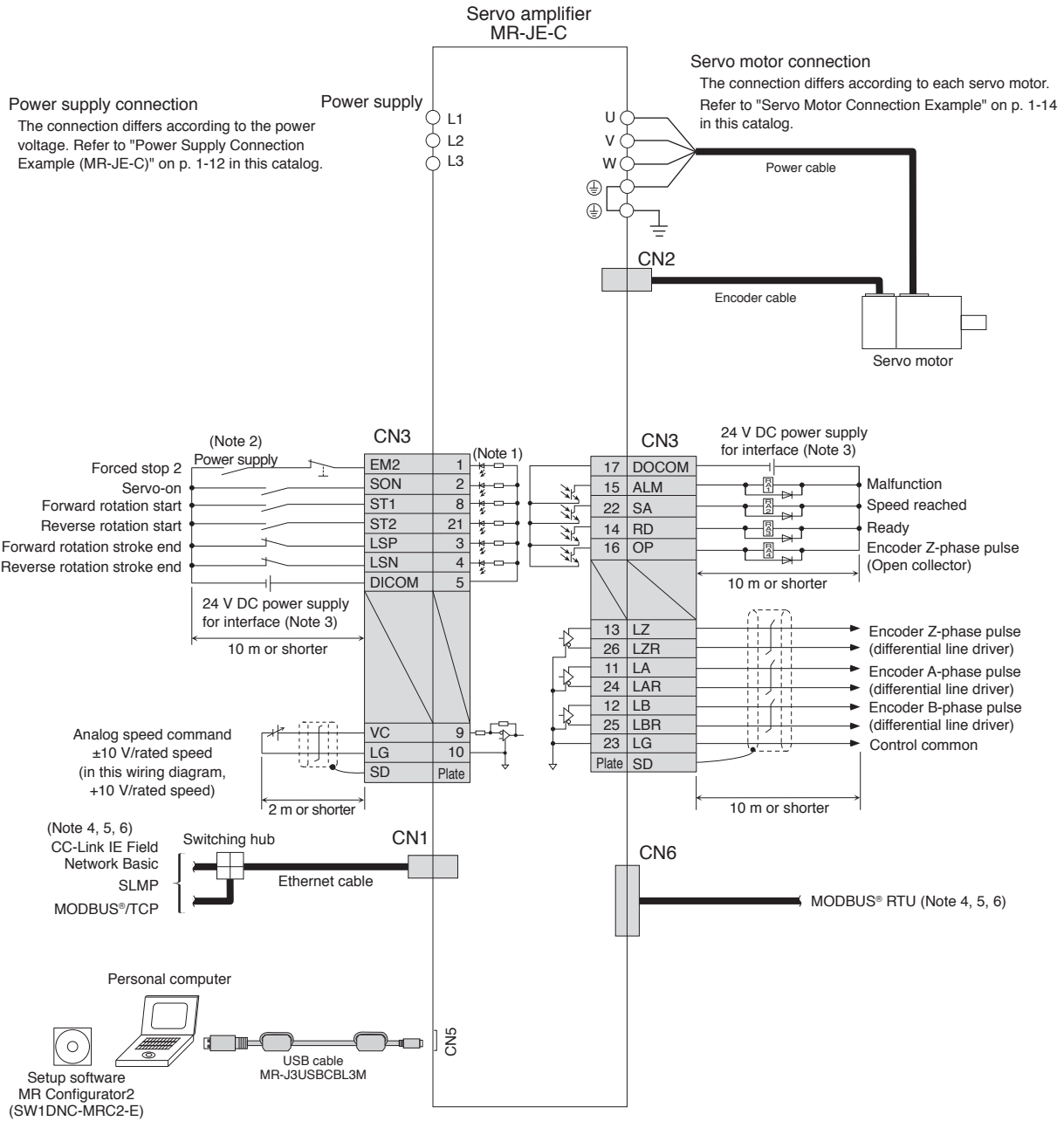

- Notes: 1. This is for sink wiring. Source wiring is also possible.  
 2. To prevent an unexpected restart of the servo amplifier, create a circuit to turn off EM2 (Forced stop 2) when the power is turned off.  
 3. For convenience of illustration, the diagram shows separate 24 V DC power supplies for input and output signals. However, the input and output signals can share a common power supply.  
 4. Refer to "MR-JE-C Servo Amplifier Instruction Manual (Network)" for communication functions.  
 5. When absolute position detection system is used, absolute position data is read with a communication function. Refer to "MR-JE-C Servo Amplifier Instruction Manual" for absolute position detection system.  
 6. Ethernet (CC-Link IE Field Network Basic, SLMP, MODBUS<sup>®</sup>/TCP) and RS-485 (MODBUS<sup>®</sup> RTU) communication functions are mutually exclusive. Only a communication function selected in [Pr. PN08] can be used.



Be sure to read through Instruction Manual for the actual wiring and use. Use the equipment after you have a full knowledge of the equipment, safety information and instructions.

MR-JE-C Standard Wiring Diagram Example: Torque Control Operation

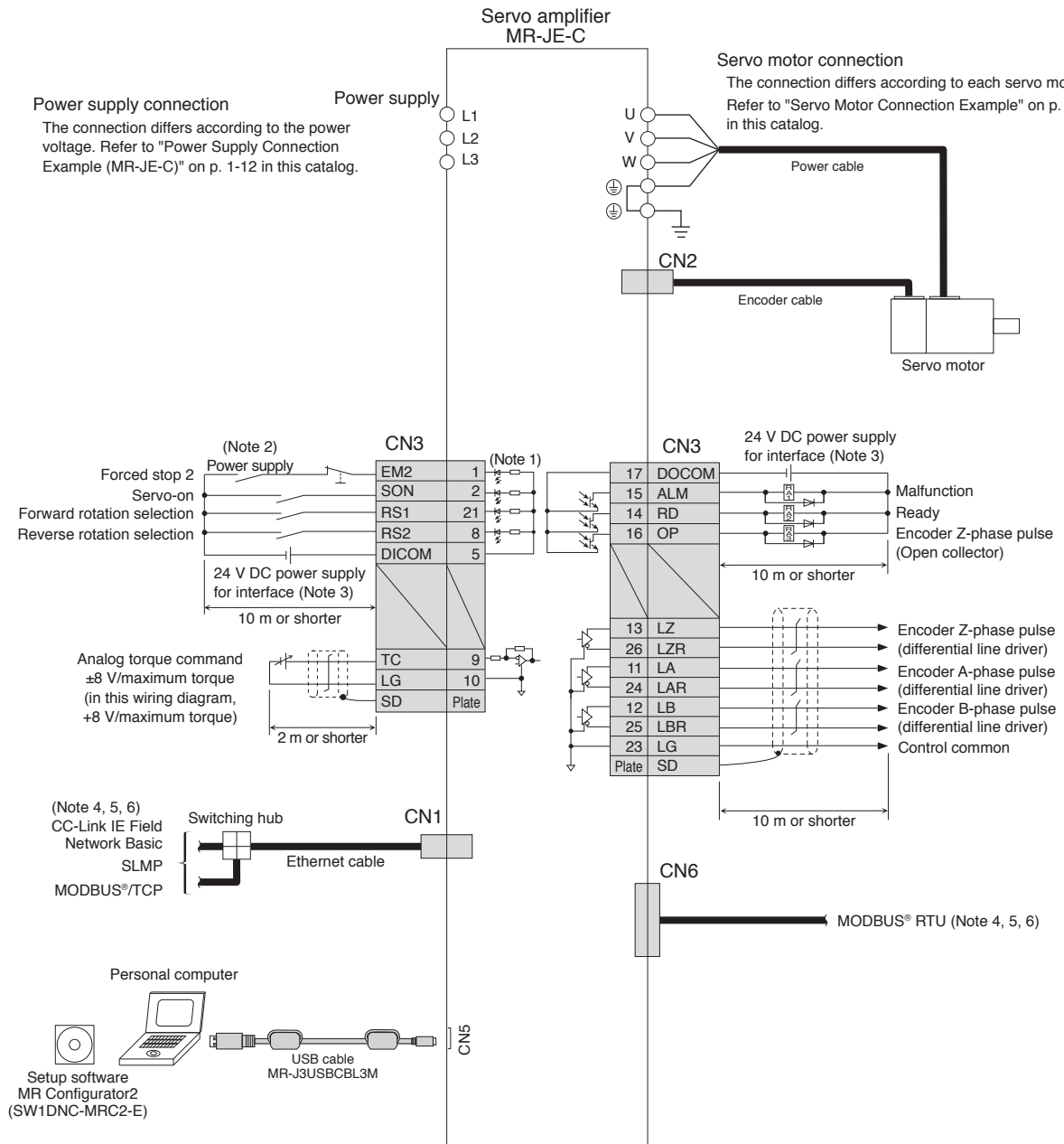

- Notes: 1. This is for sink wiring. Source wiring is also possible.  
 2. To prevent an unexpected restart of the servo amplifier, create a circuit to turn off EM2 (Forced stop 2) when the power is turned off.  
 3. For convenience of illustration, the diagram shows separate 24 V DC power supplies for input and output signals. However, the input and output signals can share a common power supply.  
 4. Refer to "MR-JE- C Servo Amplifier Instruction Manual (Network)" for communication functions.  
 5. When absolute position detection system is used, absolute position data is read with a communication function. Refer to "MR-JE- C Servo Amplifier Instruction Manual" for absolute position detection system.  
 6. Ethernet (CC-Link IE Field Network Basic, SLMP, MODBUS®/TCP) and RS-485 (MODBUS® RTU) communication functions are mutually exclusive. Only a communication function selected in [Pr. PN08] can be used.



Be sure to read through Instruction Manual for the actual wiring and use. Use the equipment after you have a full knowledge of the equipment, safety information and instructions.

## MR-JE-C Standard Wiring Diagram Example: Profile (Position/Velocity/Torque) Operation Point Table Method (Communication Interface) Indexer Method (Communication Interface)

C

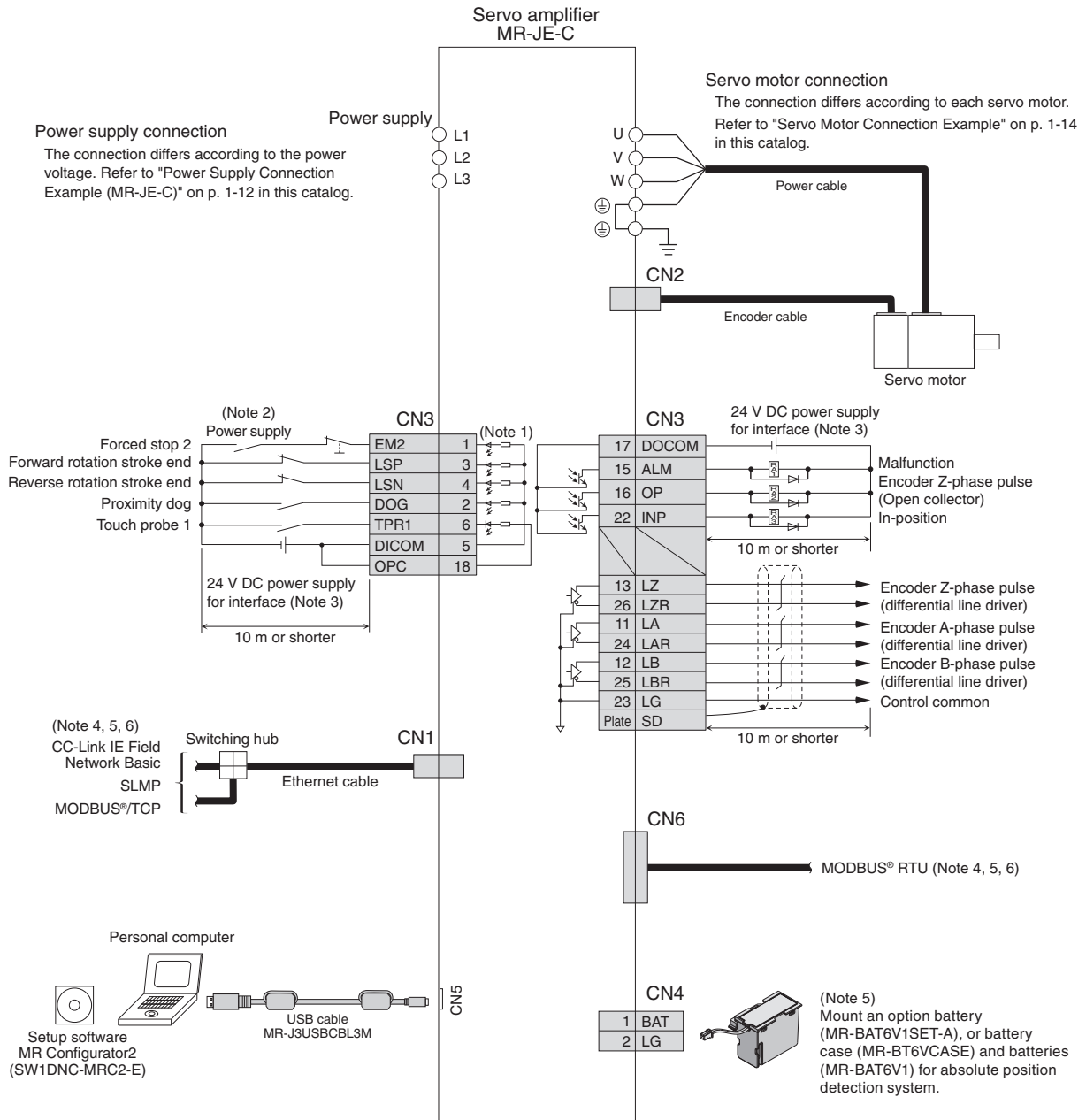

- Notes: 1. This is for sink wiring. Source wiring is also possible. However, when input devices are assigned to CN3-6 pin and CN3-19 pin, be sure to use sink wiring. Source wiring is not possible in this case.
2. To prevent an unexpected restart of the servo amplifier, create a circuit to turn off EM2 (Forced stop 2) when the power is turned off.
3. For convenience of illustration, the diagram shows separate 24 V DC power supplies for input and output signals. However, the input and output signals can share a common power supply.
4. Refer to "MR-JE-C Servo Amplifier Instruction Manual (Network)" for communication functions.
5. When absolute position detection system is used, absolute position data is read with a communication function. Refer to "MR-JE-C Servo Amplifier Instruction Manual" for absolute position detection system.
6. Ethernet (CC-Link IE Field Network Basic, SLMP, MODBUS®/TCP) and RS-485 (MODBUS® RTU) communication functions are mutually exclusive. Only a communication function selected in [Pr. PN08] can be used.



Be sure to read through Instruction Manual for the actual wiring and use. Use the equipment after you have a full knowledge of the equipment, safety information and instructions.

MR-JE-C Standard Wiring Diagram Example: Point Table Operation (General-Purpose Interface) **C**

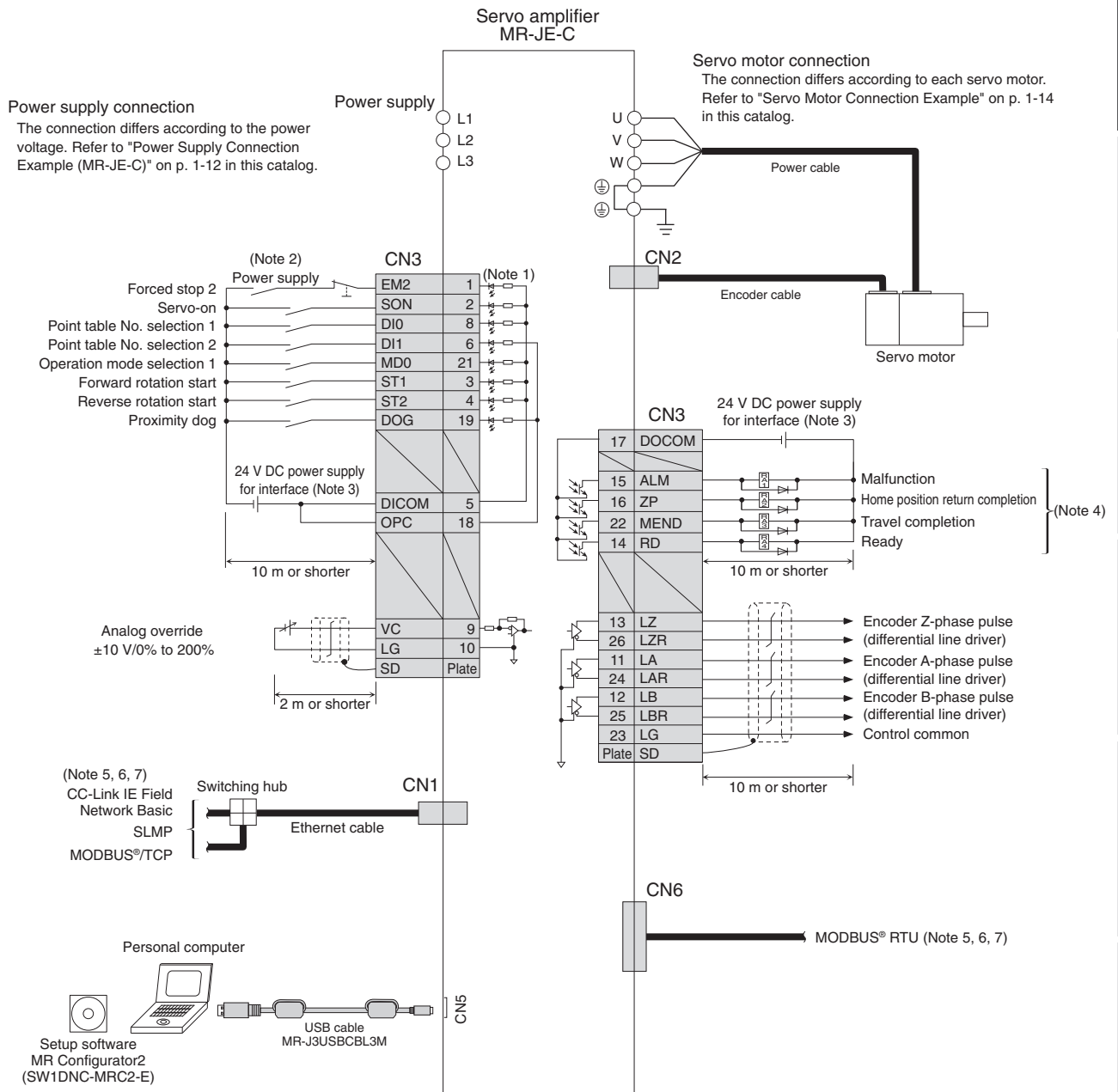

Servo Amplifiers

Servo Motors

Options/Peripheral Equipment

LVS/Wires

Product List

Cautions

**!** Be sure to read through Instruction Manual for the actual wiring and use. Use the equipment after you have a full knowledge of the equipment, safety information and instructions.

## MR-JE-C Standard Wiring Diagram Example: Indexer Operation (General-Purpose Interface) C

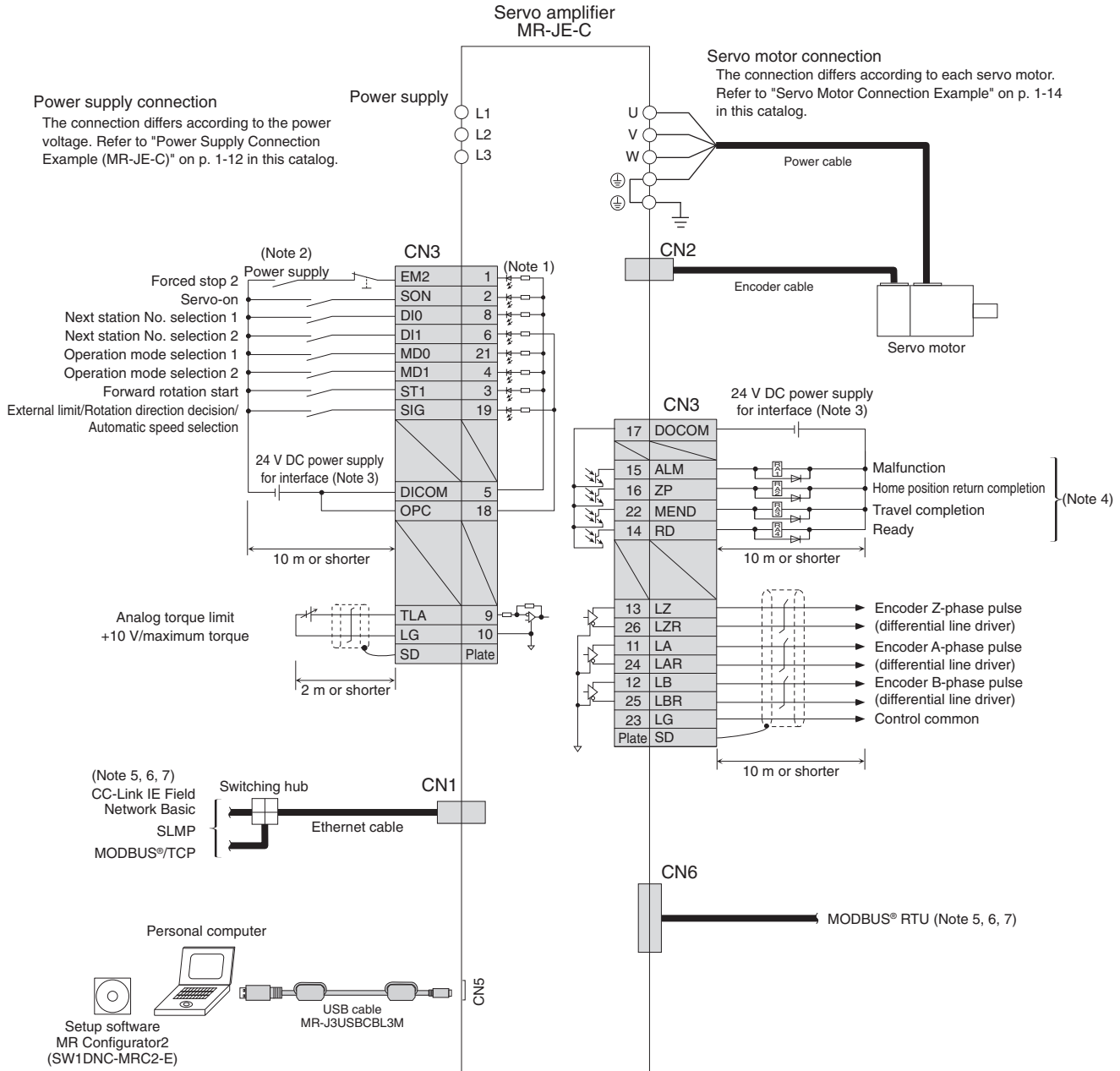

- Notes: 1. Only sink wiring is supported.  
 2. To prevent an unexpected restart of the servo amplifier, create a circuit to turn off EM2 (Forced stop 2) when the power is turned off.  
 3. For convenience of illustration, the diagram shows separate 24 V DC power supplies for input and output signals. However, the input and output signals can share a common power supply.  
 4. These signals are recommended assignments. The device can be changed with [Pr. PD29] to [Pr. PD32].  
 5. Refer to "MR-JE-C Servo Amplifier Instruction Manual (Network)" for communication functions.  
 6. When absolute position detection system is used, absolute position data is read with a communication function. Refer to "MR-JE-C Servo Amplifier Instruction Manual" for absolute position detection system.  
 7. Ethernet (CC-Link IE Field Network Basic, SLMP, MODBUS®/TCP) and RS-485 (MODBUS® RTU) communication functions are mutually exclusive. Only a communication function selected in [Pr. PN08] can be used.



Be sure to read through Instruction Manual for the actual wiring and use. Use the equipment after you have a full knowledge of the equipment, safety information and instructions.



**Power Supply Connection Example (MR-JE-C)**

● For 1-phase 200 V AC, 1 kW or smaller

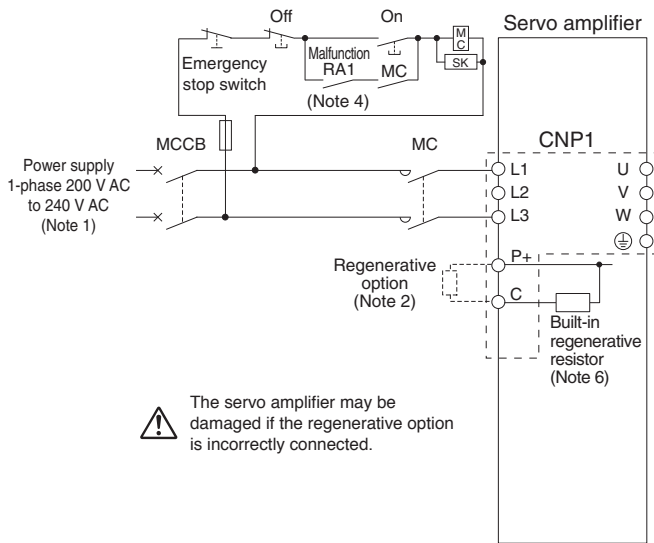

● For 3-phase 200 V AC, 1 kW or smaller

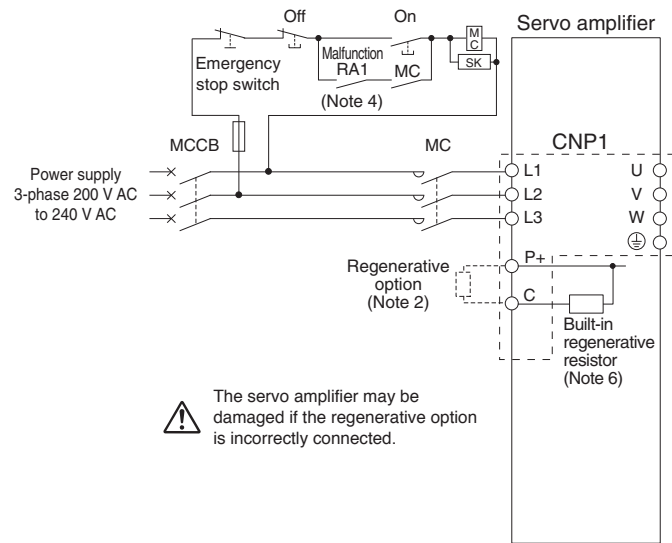

● For 1-phase 200 V AC, 2 kW

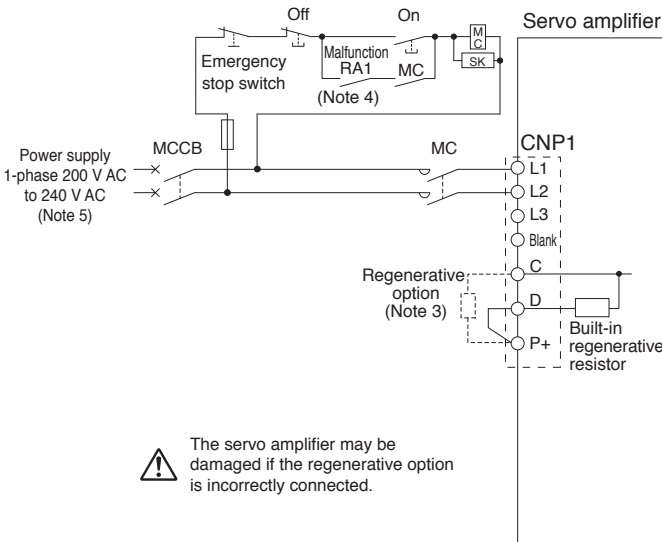

● For 3-phase 200 V AC, 2 kW and 3 kW

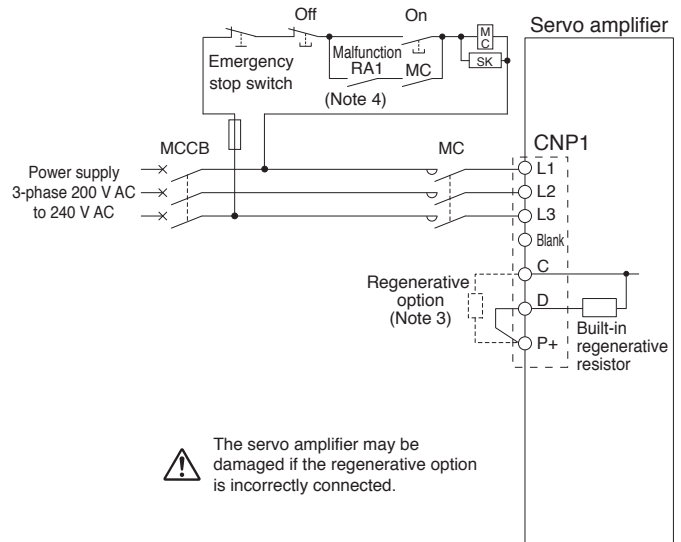

- Notes: 1. For 1-phase 200 V AC to 240 V AC, connect the power supply to L1 and L3 terminals. Do not connect anything to L2.  
 2. Disconnect the wires for the built-in regenerative resistor (P+ and C), and remove the resistor when connecting the regenerative option externally.  
 3. Disconnect a short-circuit bar between P+ and D when connecting the regenerative option externally.  
 4. Create a power circuit to turn off the magnetic contactor when ALM (Malfunction) is off (alarm occurrence).  
 5. For 1-phase 200 V AC to 240 V AC, connect the power supply to L1 and L2 terminals. Do not connect anything to L3.  
 6. The servo amplifiers of 0.2 kW or smaller do not have a built-in regenerative resistor.



Be sure to read through Instruction Manual for the actual wiring and use. Use the equipment after you have a full knowledge of the equipment, safety information and instructions.

## RS-485 Serial Communication Connection Example

C

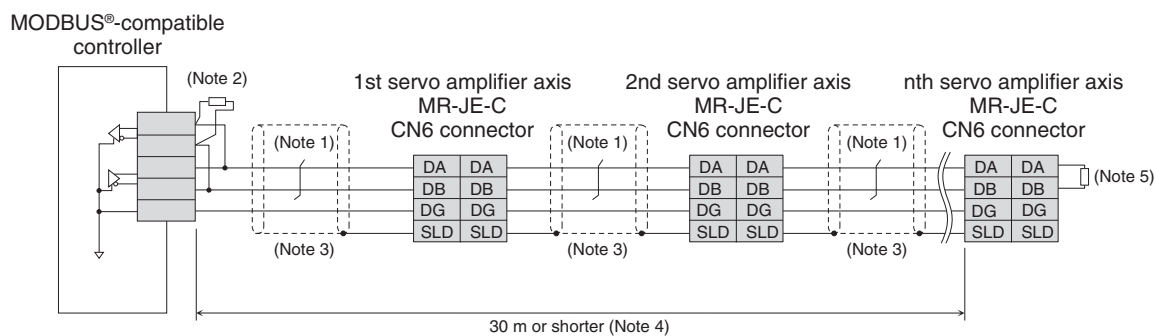

- Notes:
1. Twist the wires from DA and DB together.
  2. Terminate with a 150  $\Omega$  resistor if the MODBUS-compatible controller does not have a built-in termination resistor.
  3. It is recommended that the cable be shielded.
  4. The cable length must be 30 m or shorter in a low-noise environment. When connecting multiple axes, also keep the overall length within 30 m.
  5. For the final axis, terminate with a 150  $\Omega$  resistor between DA and DB.



Be sure to read through Instruction Manual for the actual wiring and use. Use the equipment after you have a full knowledge of the equipment, safety information and instructions.



# Servo Amplifiers

C

## MR-JE-C Dimensions

- MR-JE-10C
- MR-JE-20C
- MR-JE-40C

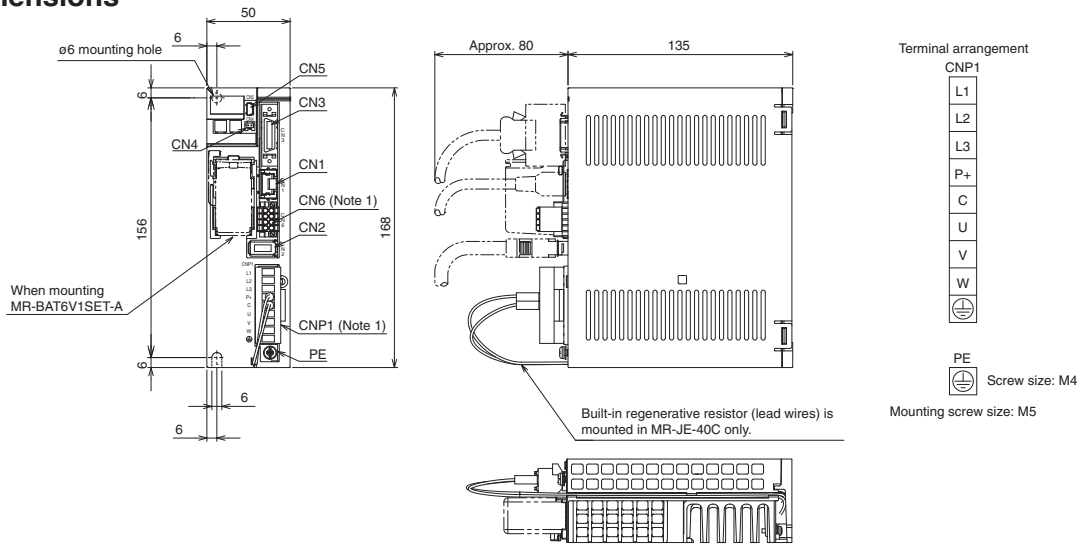

[Unit: mm]

- MR-JE-70C
- MR-JE-100C

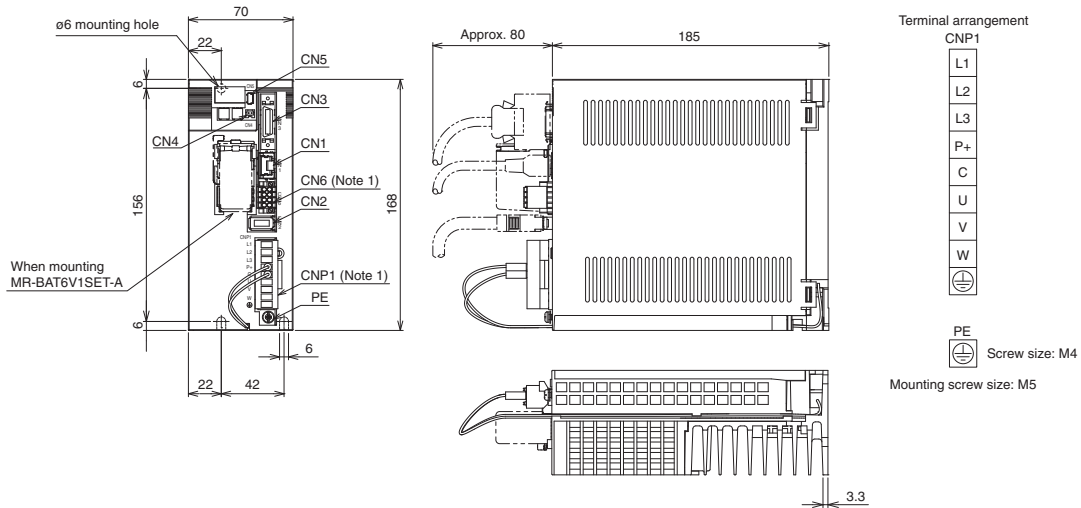

[Unit: mm]

- MR-JE-200C
- MR-JE-300C

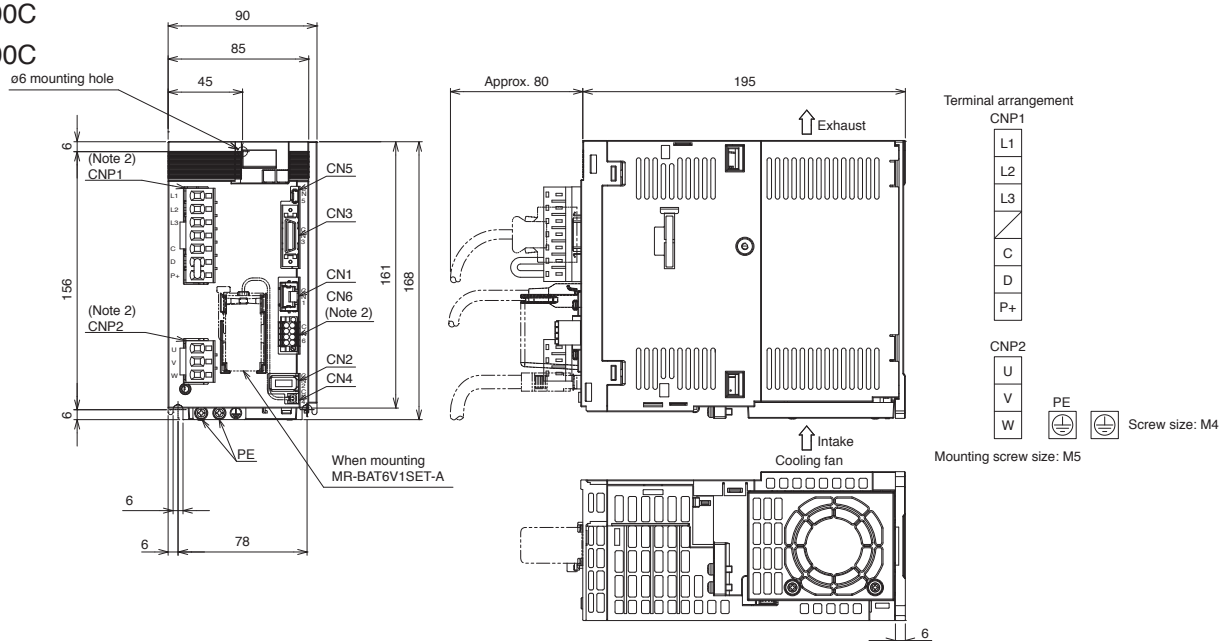

[Unit: mm]

Notes: 1. CNP1 and CN6 connectors are supplied with the servo amplifier.  
2. CNP1, CNP2, and CN6 connectors are supplied with the servo amplifier.

**MR-JE-B Connections with Peripheral Equipment** (Note 1)

Peripheral equipment is connected to MR-JE-B as described below. Connectors, cables, options, and other necessary equipment are available so that users can set up the servo amplifier easily and start using it right away.

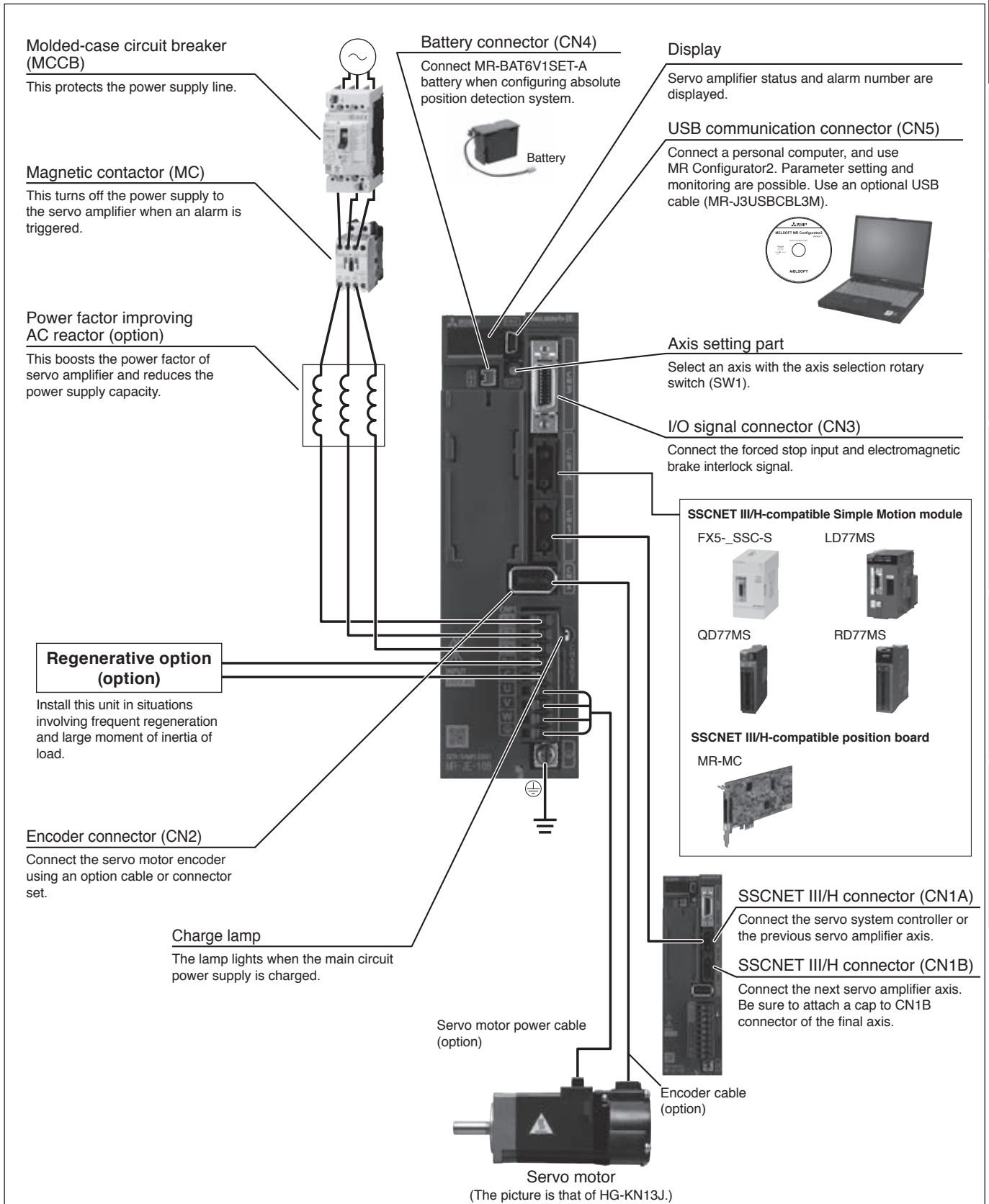

Notes: 1. The connection with the peripheral equipment is an example for MR-JE-100B or smaller servo amplifiers. Refer to "MR-JE-\_B Servo Amplifier Instruction Manual" for the actual connections.

## MR-JE-B (SSCNET III/H Interface) Specifications

**B**

Servo amplifier model MR-JE-		10B	20B	40B	70B	100B	200B	300B	
Output	Rated voltage	3-phase 170 V AC							
	Rated current [A]	1.1	1.5	2.8	5.8	6.0	11.0	11.0	
Power supply input	Voltage/frequency <sup>(Note 1)</sup>	3-phase or 1-phase 200 V AC to 240 V AC, 50 Hz/60 Hz				3-phase or 1-phase 200 V AC to 240 V AC, 50 Hz/60 Hz <sup>(Note 8)</sup>		3-phase 200 V AC to 240 V AC, 50 Hz/60 Hz	
	Rated current <sup>(Note 7)</sup> [A]	0.9	1.5	2.6	3.8	5.0	10.5	14.0	
	Permissible voltage fluctuation	3-phase or 1-phase 170 V AC to 264 V AC				3-phase or 1-phase 170 V AC to 264 V AC <sup>(Note 8)</sup>		3-phase 170 V AC to 264 V AC	
	Permissible frequency fluctuation	±5% maximum							
Interface power supply		24 V DC ± 10% (required current capacity: 0.3 A) <sup>(Note 11)</sup>							
Control method		Sine-wave PWM control/current control method							
Permissible regenerative power of the built-in regenerative resistor <sup>(Note 2, 3)</sup> [W]		-	-	10	20	20	100	100	
Dynamic brake <sup>(Note 4)</sup>		Built-in							
SSCNET III/H command communication cycle <sup>(Note 6)</sup>		0.444 ms, 0.888 ms							
Communication function	USB	Connect a personal computer (MR Configurator2 compatible)							
Servo function		Advanced vibration suppression control II, adaptive filter II, robust filter, auto tuning, one-touch tuning, tough drive function, drive recorder function, tightening & press-fit control, machine diagnosis function, power monitoring function, lost motion compensation function							
Protective functions		Overcurrent shut-off, regenerative overvoltage shut-off, overload shut-off (electronic thermal), servo motor overheat protection, encoder error protection, regenerative error protection, undervoltage protection, instantaneous power failure protection, overspeed protection, error excessive protection, hotline forced stop function <sup>(Note 9)</sup>							
Compliance with global standards		Refer to "Compliance with Global Standards and Regulations" on p. 25 in this catalog.							
Structure (IP rating)		Natural cooling, open (IP20)					Force cooling, open (IP20)		
Close mounting <sup>(Note 5)</sup>	3-phase power supply input	Possible							
	1-phase power supply input	Possible				Not possible		-	
Environment	Ambient temperature	Operation: 0 °C to 55 °C (non-freezing), storage: -20 °C to 65 °C (non-freezing)							
	Ambient humidity	Operation/storage: 5 %RH to 90 %RH (non-condensing)							
	Ambience	Indoors (no direct sunlight); no corrosive gas, inflammable gas, oil mist or dust							
	Altitude	2000 m or less above sea level <sup>(Note 10)</sup>							
Vibration resistance		5.9 m/s <sup>2</sup> at 10 Hz to 55 Hz (directions of X, Y and Z axes)							
Mass [kg]		0.8	0.8	0.8	1.5	1.5	2.1	2.1	

- Notes: 1. Rated output and speed of a servo motor are applicable when the servo amplifier is operated within the specified power supply voltage and frequency.  
2. Select the most suitable regenerative option for your system with our capacity selection software.  
3. Refer to "Regenerative Option" in this catalog for the permissible regenerative power [W] when a regenerative option is used.  
4. When using the dynamic brake, refer to "MR-JE-\_B Servo Amplifier Instruction Manual" for the permissible load to motor inertia ratio.  
5. When the servo amplifiers are closely mounted, keep the ambient temperature within 0 °C to 45 °C, or use the servo amplifiers at 75% or less of the effective load ratio.  
6. The command communication cycle depends on the servo system controller specifications and the number of axes connected.  
7. This value is applicable when a 3-phase power supply is used.  
8. When a 1-phase 200 V AC to 240 V AC power supply is used, use the servo amplifiers at 75% or less of the effective load ratio.  
9. When an alarm occurs on MR-JE-B servo amplifier, the hot line forced stop signal will be sent to other servo amplifiers through a servo system controller, and all the servo motors that are operated normally by MR-JE-B servo amplifiers decelerate to a stop. Refer to "MR-JE-\_B Servo Amplifier Instruction Manual" for details.  
10. Refer to "MR-JE-\_B Servo Amplifier Instruction Manual" for the restrictions when using the servo amplifiers at altitude exceeding 1000 m and up to 2000 m above sea level.  
11. A current capacity is 0.1 A for the servo amplifiers manufactured in April 2016 or earlier (May 2016 or earlier if manufactured in China).

MR-JE-B Standard Wiring Diagram Example

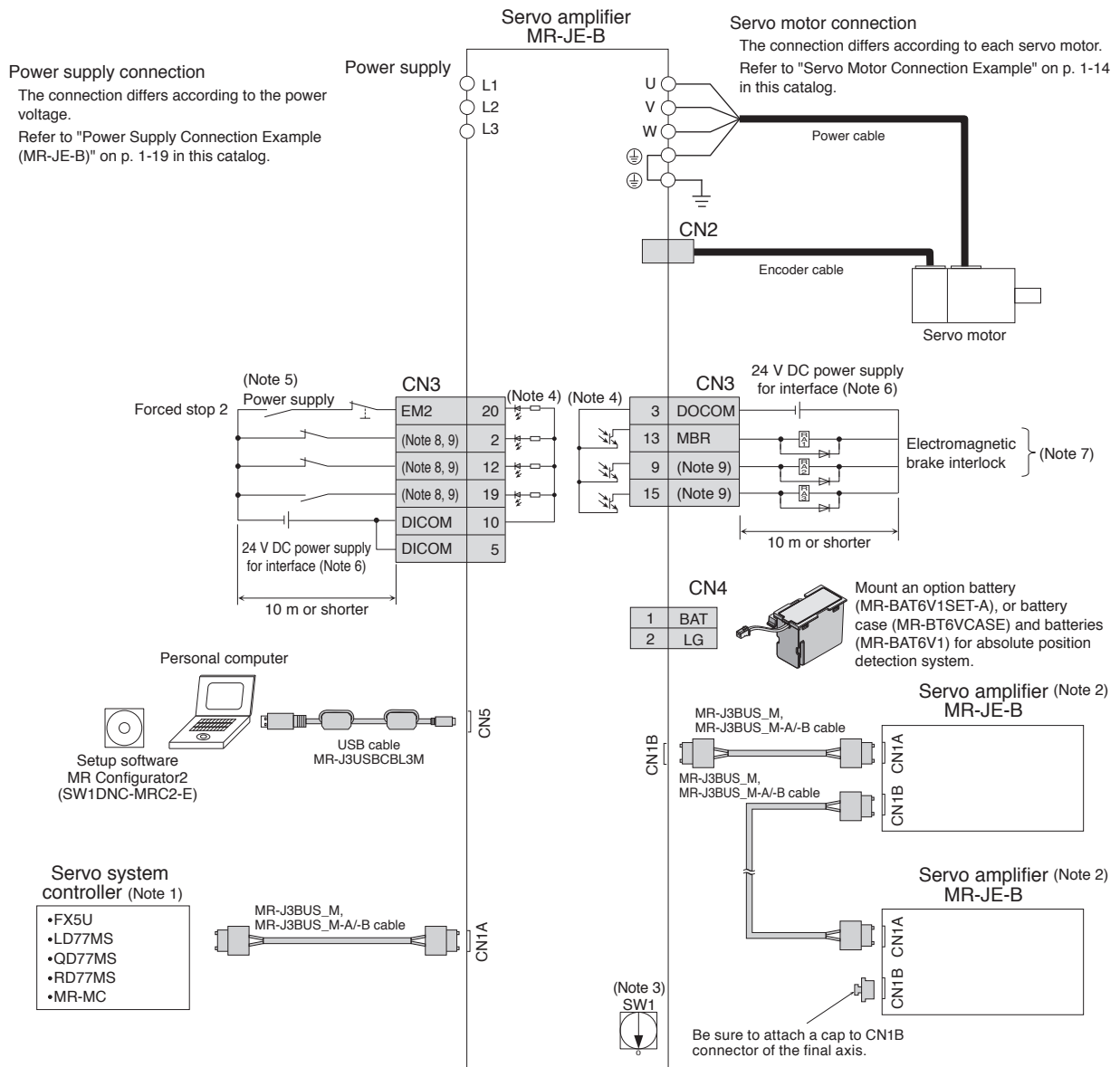

- Notes: 1. For details such as setting the servo system controllers, refer to programming manual or user's manual for the controllers.  
 2. Connections for the second and following axes are omitted.  
 3. Up to 16 axes are set with an axis selection rotary switch (SW1). Note that the number of the connectable axes depends on the servo system controller specifications.  
 4. This is for sink wiring. Source wiring is also possible.  
 5. To prevent an unexpected restart of the servo amplifier, create a circuit to turn off EM2 (Forced stop 2) when the power is turned off.  
 6. For convenience of illustration, the diagram shows separate 24 V DC power supplies for input and output signals. However, the input and output signals can share a common power supply.  
 7. Devices assigned to CN3-13, CN3-9, and CN3-15 pins can be changed with [Pr. PD07], [Pr. PD08], and [Pr. PD09]. No signal is assigned to CN3-9 and CN3-15 pins by default. Assign ALM (Malfunction) to a pin of CN3 connector by setting [Pr. PD08] or [Pr. PD09] to " \_ 0 3".  
 8. Devices assigned to CN3-2, CN3-12, and CN3-19 pins can be changed with [Pr. PD03], [Pr. PD04], and [Pr. PD05].  
 9. CN3-2, CN3-9, CN3-12, CN3-15, and CN3-19 pins are available with the servo amplifiers with software version C5 or later, and manufactured in May 2016 or later. For the servo amplifiers manufactured in China, these pins have been available from June 2016 production. In addition, use MR Configurator2 with software version 1.60N or later.

Be sure to read through Instruction Manual for the actual wiring and use. Use the equipment after you have a full knowledge of the equipment, safety information and instructions.

# Servo Amplifiers

## Power Supply Connection Example (MR-JE-B)

**B**

● For 1-phase 200 V AC, 1 kW or smaller

● For 3-phase 200 V AC, 1 kW or smaller

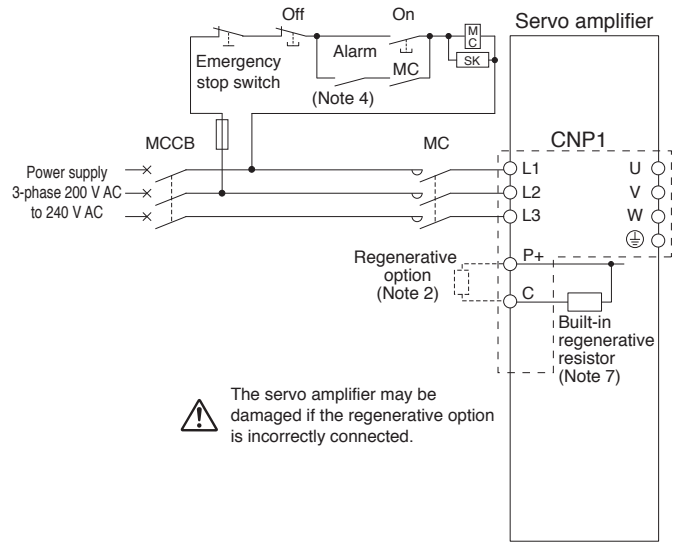
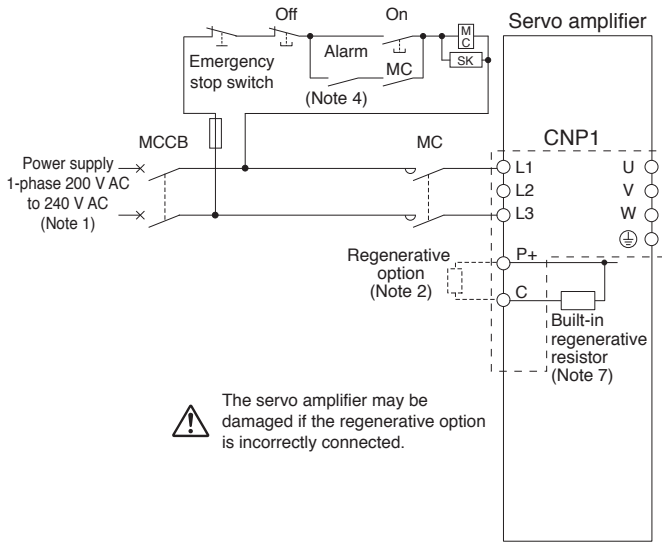

● For 1-phase 200 V AC, 2 kW

● For 3-phase 200 V AC, 2 kW and 3 kW

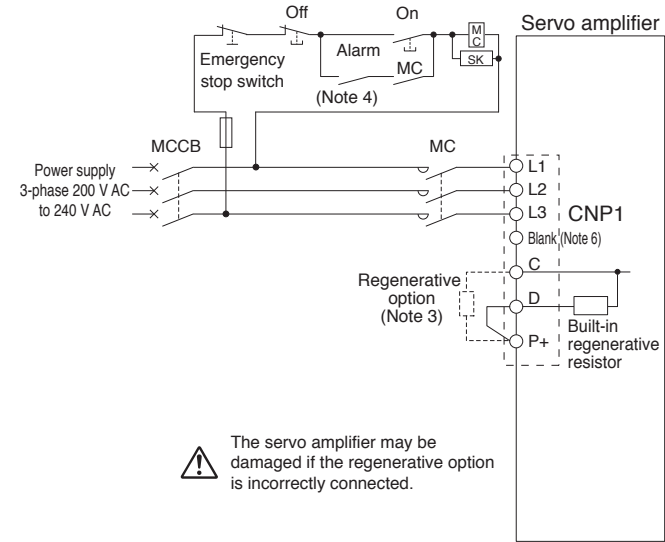
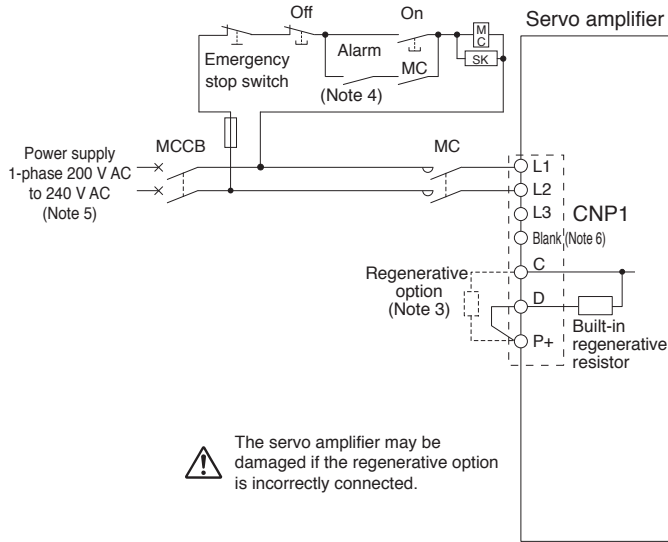

- Notes: 1. For 1-phase 200 V AC to 240 V AC, connect the power supply to L1 and L3 terminals. Do not connect anything to L2.  
 2. Disconnect the wires for the built-in regenerative resistor (P+ and C), and remove the resistor when connecting the regenerative option externally.  
 3. Disconnect a short-circuit bar between P+ and D when connecting the regenerative option externally.  
 4. Create a power circuit to turn off the magnetic contactors of all the servo amplifiers after an alarm is detected on the servo system controller side.  
 5. For 1-phase 200 V AC to 240 V AC, connect the power supply to L1 and L2 terminals. Do not connect anything to L3.  
 6. The servo amplifiers manufactured in December 2016 or later do not have an N- terminal.  
 7. The servo amplifiers of 0.2 kW or smaller do not have a built-in regenerative resistor.



Be sure to read through Instruction Manual for the actual wiring and use. Use the equipment after you have a full knowledge of the equipment, safety information and instructions.



**MR-JE-B Dimensions**

- MR-JE-10B
- MR-JE-20B
- MR-JE-40B

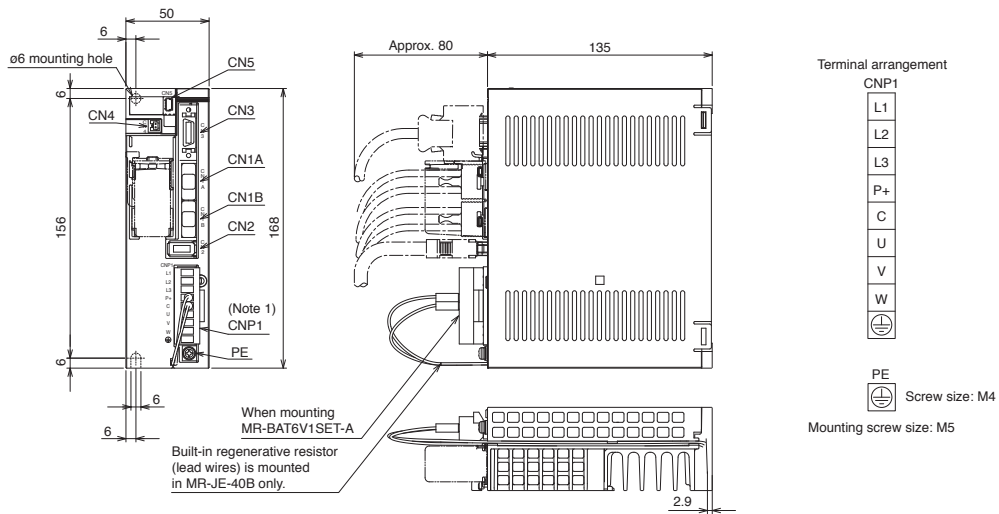

[Unit: mm]

- MR-JE-70B
- MR-JE-100B

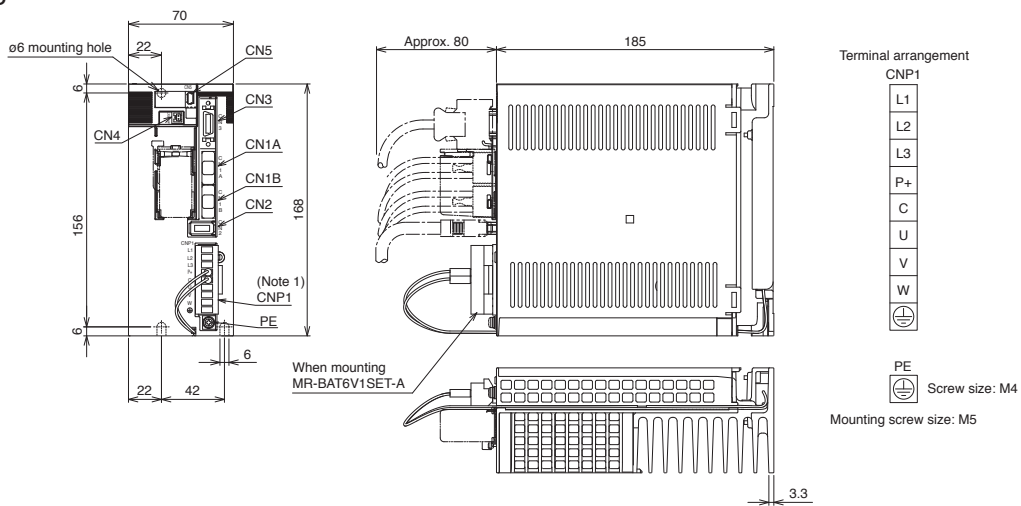

[Unit: mm]

- MR-JE-200B
- MR-JE-300B

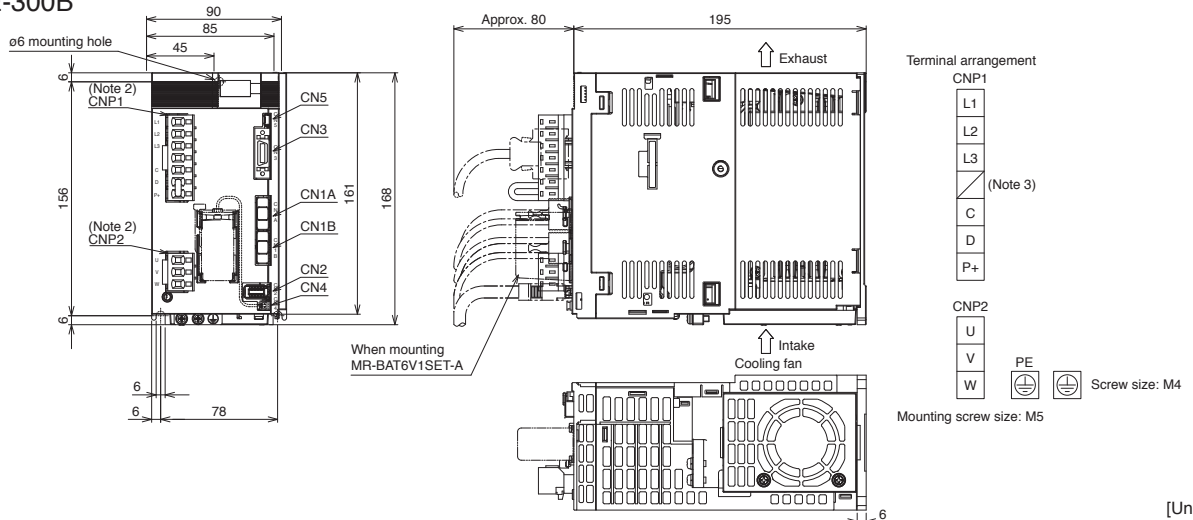

[Unit: mm]

Notes: 1. CNP1 connector is supplied with the servo amplifier.  
2. CNP1 and CNP2 connectors are supplied with the servo amplifier.  
3. The servo amplifiers manufactured in December 2016 or later do not have an N-terminal.

# Servo Amplifiers

## MR-JE-A Connections with Peripheral Equipment (Note 1)

A

Peripheral equipment is connected to MR-JE-A as described below. Connectors, cables, options, and other necessary equipment are available so that users can set up the servo amplifier easily and start using it right away.

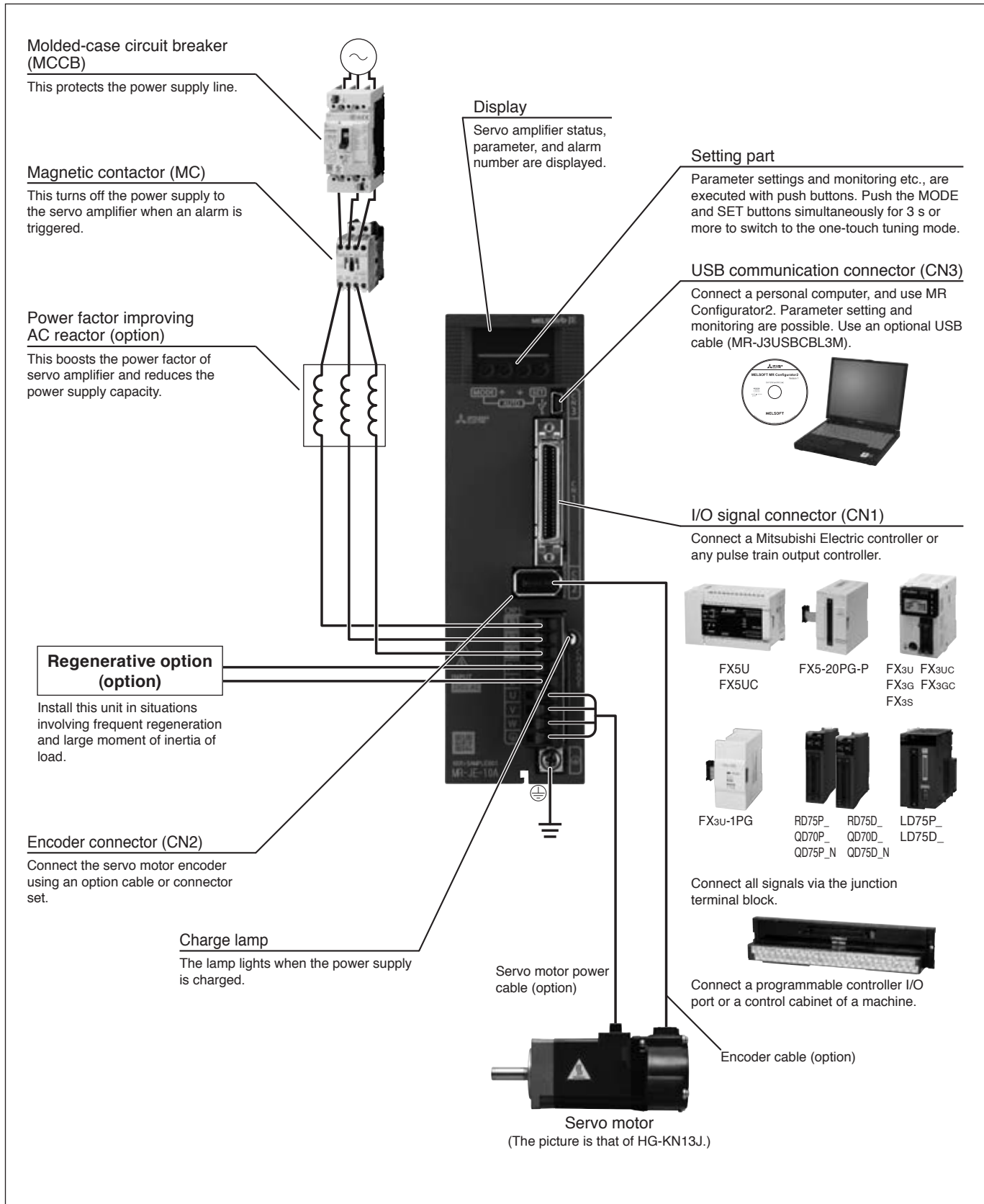

Notes: 1. The connection with the peripheral equipment is an example for MR-JE-100A or smaller servo amplifiers. Refer to "MR-JE- A Servo Amplifier Instruction Manual" for the actual connections.

MR-JE-A (General-Purpose Interface) Specifications

A

Servo amplifier model MR-JE-		10A	20A	40A	70A	100A	200A	300A	
Output	Rated voltage	3-phase 170 V AC							
	Rated current [A]	1.1	1.5	2.8	5.8	6.0	11.0	11.0	
Power supply input	Voltage/frequency (Note 1)	3-phase or 1-phase 200 V AC to 240 V AC, 50 Hz/60 Hz				3-phase or 1-phase 200 V AC to 240 V AC, 50 Hz/60 Hz (Note 9)		3-phase 200 V AC to 240 V AC, 50 Hz/60 Hz	
	Rated current (Note 7) [A]	0.9	1.5	2.6	3.8	5.0	10.5	14.0	
	Permissible voltage fluctuation	3-phase or 1-phase 170 V AC to 264 V AC				3-phase or 1-phase 170 V AC to 264 V AC (Note 9)		3-phase 170 V AC to 264 V AC	
	Permissible frequency fluctuation	±5% maximum							
Interface power supply		24 V DC ± 10% (required current capacity: 0.3 A)							
Control method		Sine-wave PWM control/current control method							
Permissible regenerative power of the built-in regenerative resistor (Note 2, 3) [W]		-	-	10	20	20	100	100	
Dynamic brake (Note 4, 8)		Built-in							
Communication function	USB	Connect a personal computer (MR Configurator2 compatible)							
	RS-422/RS-485 (Note 10)	Connect a controller (1:n communication up to 32 axes) (Note 6)							
Encoder output pulse		Compatible (A/B/Z-phase pulse)							
Analog monitor		2 channels							
Position control mode	Maximum input pulse frequency	4 Mpulses/s (when using differential receiver), 200 kpulses/s (when using open-collector)							
	Positioning feedback pulse	Encoder resolution: 131072 pulses/rev							
	Command pulse multiplying factor	Electronic gear A/B multiple, A: 1 to 16777215, B: 1 to 16777215, 1/10 < A/B < 4000							
	In-position range setting	0 pulse to ±65535 pulses (command pulse unit)							
	Error excessive	±3 rotations							
	Torque limit	Set by parameters or external analog input (0 V DC to +10 V DC/maximum torque)							
Speed control mode	Speed control range	Analog speed command 1:2000, internal speed command 1:5000							
	Analog speed command input	0 V DC to ±10 V DC/rated speed (Speed at 10 V is changeable with [Pr. PC12].)							
	Speed fluctuation rate	±0.01% maximum (load fluctuation: 0% to 100%), 0% (power fluctuation: ±10%) ±0.2% maximum (ambient temperature: 25 °C ± 10 °C) only when using analog speed command							
	Torque limit	Set by parameters or external analog input (0 V DC to +10 V DC/maximum torque)							
Torque control mode	Analog torque command input	0 V DC to ±8 V DC/maximum torque (input impedance: 10 kΩ to 12 kΩ)							
	Speed limit	Set by parameters or external analog input (0 V DC to ± 10 V DC/rated speed)							
Positioning mode		Point table method, program method							
Servo function		Advanced vibration suppression control II, adaptive filter II, robust filter, auto tuning, one-touch tuning, tough drive function, drive recorder function, machine diagnosis function, power monitoring function, lost motion compensation function							
Protective functions		Overcurrent shut-off, regenerative overvoltage shut-off, overload shut-off (electronic thermal), servo motor overheat protection, encoder error protection, regenerative error protection, undervoltage protection, instantaneous power failure protection, overspeed protection, error excessive protection							
Compliance with global standards		Refer to "Compliance with Global Standards and Regulations" on p. 25 in this catalog.							
Structure (IP rating)		Natural cooling, open (IP20)					Force cooling, open (IP20)		
Close mounting (Note 5)	3-phase power supply input	Possible							
	1-phase power supply input	Possible				Not possible		-	
Environment	Ambient temperature	Operation: 0 °C to 55 °C (non-freezing), storage: -20 °C to 65 °C (non-freezing)							
	Ambient humidity	Operation/storage: 5 %RH to 90 %RH (non-condensing)							
	Ambience	Indoors (no direct sunlight); no corrosive gas, inflammable gas, oil mist or dust							
	Altitude	2000 m or less above sea level (Note 11)							
Vibration resistance		5.9 m/s <sup>2</sup> at 10 Hz to 55 Hz (directions of X, Y and Z axes)							
Mass [kg]		0.8	0.8	0.8	1.5	1.5	2.1	2.1	

- Notes: 1. Rated output and speed of a servo motor are applicable when the servo amplifier, combined with the servo motor, is operated within the specified power supply voltage and frequency.  
 2. Select the most suitable regenerative option for your system with our capacity selection software.  
 3. Refer to "Regenerative Option" in this catalog for the permissible regenerative power [W] when a regenerative option is used.  
 4. When using the dynamic brake, refer to "MR-JE-\_A Servo Amplifier Instruction Manual" for the permissible load to motor inertia ratio.  
 5. When the servo amplifiers are closely mounted, keep the ambient temperature within 0 °C to 45 °C, or use the servo amplifiers at 75% or less of the effective load ratio.  
 6. RS-422 communication function is supported by the servo amplifiers manufactured on December 2013 or later. RS-485 communication function is supported by the servo amplifiers manufactured on May 2015 or later. Refer to "MR-JE-\_A Servo Amplifier Instruction Manual" for how to identify the manufacturing date of the products.  
 7. This value is applicable when a 3-phase power supply is used.  
 8. The coast distance by dynamic brake of HG-KN/HG-SN servo motor series may be different from prior HF-KN/HF-SN. Contact your local sales office for more details.  
 9. When 1-phase 200 V AC to 240 V AC power supply is used, use the servo amplifiers at 75% or less of the effective load ratio.  
 10. Compatible with Mitsubishi Electric general-purpose AC servo protocol (RS-422/RS-485 communication) and MODBUS® RTU protocol (RS-485 communication).  
 11. Refer to "MR-JE-\_A Servo Amplifier Instruction Manual" for the restrictions when using the servo amplifiers at altitude exceeding 1000 m and up to 2000 m above sea level.

Servo Amplifiers

Servo Motors

Options/Peripheral Equipment

LVS/Wires

Product List

Cautions

## MR-JE-A Standard Wiring Diagram Example: Position Control Operation

A

### Connecting to FX5U

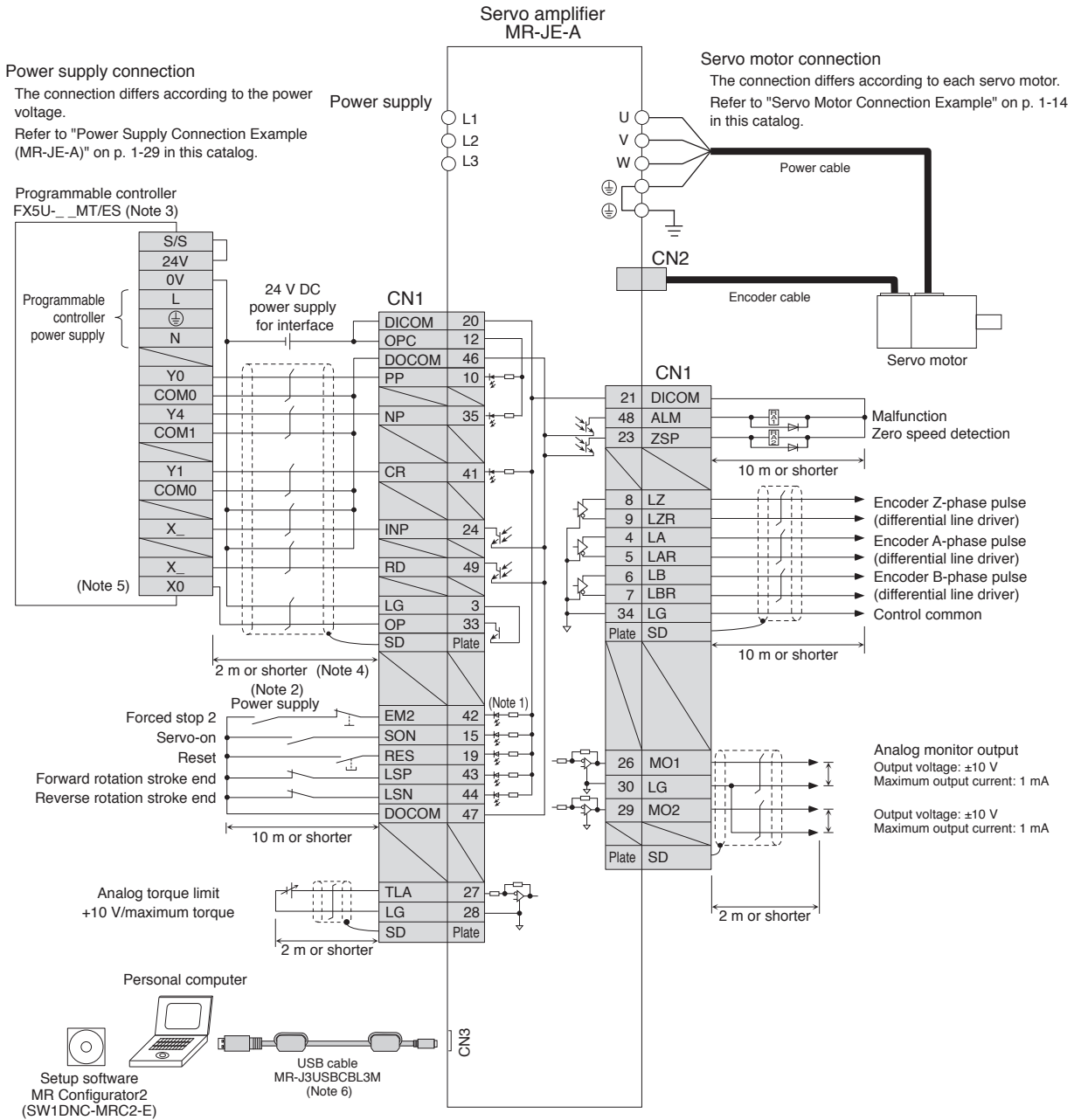

- Notes: 1. This is for sink wiring. Source wiring is also possible.  
 2. To prevent an unexpected restart of the servo amplifier, create a circuit to turn off EM2 (Forced stop 2) when the power is turned off.  
 3. Select the number of input/output points of the programmable controller according to your system.  
 4. It is recommended that the connection be 2 m or shorter because an open-collector system is used.  
 5. Select from the range of X0 to X5.  
 6. USB and RS-422/RS-485 communication functions are mutually exclusive. Do not use them at the same time.



Be sure to read through Instruction Manual for the actual wiring and use. Use the equipment after you have a full knowledge of the equipment, safety information and instructions.

MR-JE-A Standard Wiring Diagram Example: Position Control Operation

Connecting to QD75D/LD75D/RD75D

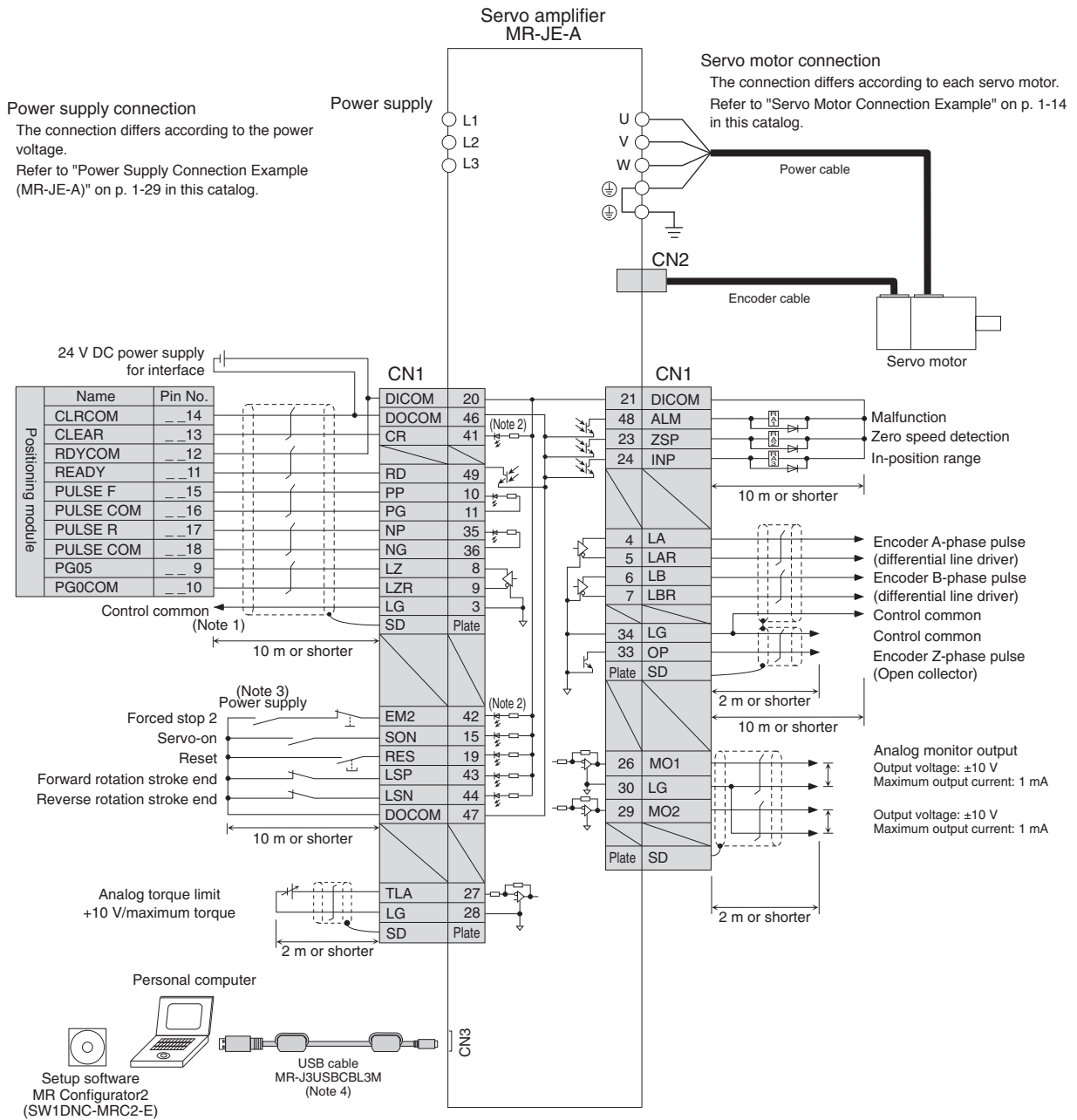

- Notes: 1. This connection is not necessary for QD75D/LD75D/RD75D Positioning module. Note that the connection between LG and control common terminal is recommended for some Positioning modules to improve noise tolerance.  
2. This is for sink wiring. Source wiring is also possible.  
3. To prevent an unexpected restart of the servo amplifier, create a circuit to turn off EM2 (Forced stop 2) when the power is turned off.  
4. USB and RS-422/RS-485 communication functions are mutually exclusive. Do not use them at the same time.



Be sure to read through Instruction Manual for the actual wiring and use. Use the equipment after you have a full knowledge of the equipment, safety information and instructions.

## MR-JE-A Standard Wiring Diagram Example: Speed Control Operation

A

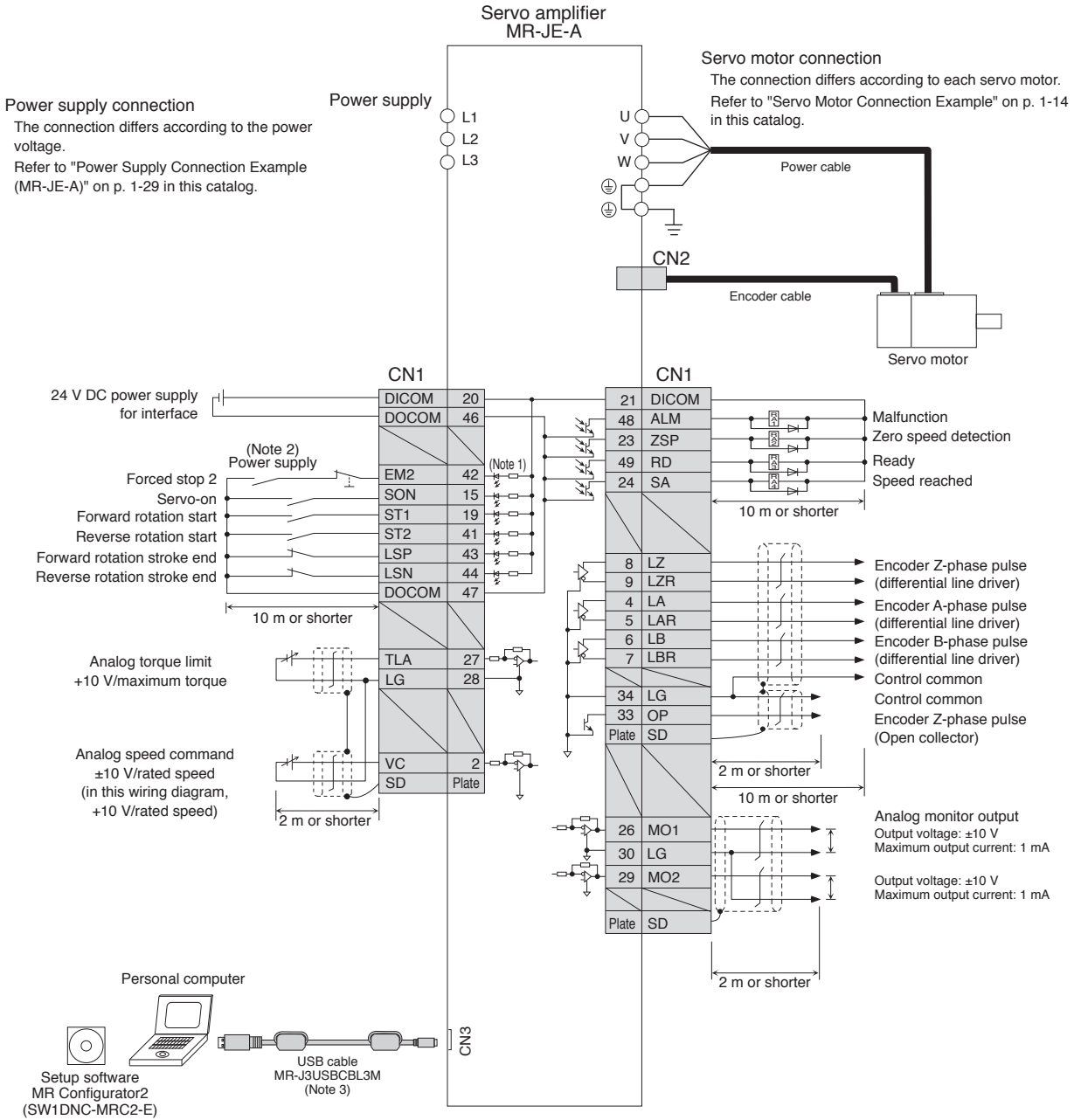

Notes: 1. This is for sink wiring. Source wiring is also possible.

2. To prevent an unexpected restart of the servo amplifier, create a circuit to turn off EM2 (Forced stop 2) when the power is turned off.

3. USB and RS-422/RS-485 communication functions are mutually exclusive. Do not use them at the same time.



Be sure to read through Instruction Manual for the actual wiring and use. Use the equipment after you have a full knowledge of the equipment, safety information and instructions.

MR-JE-A Standard Wiring Diagram Example: Torque Control Operation

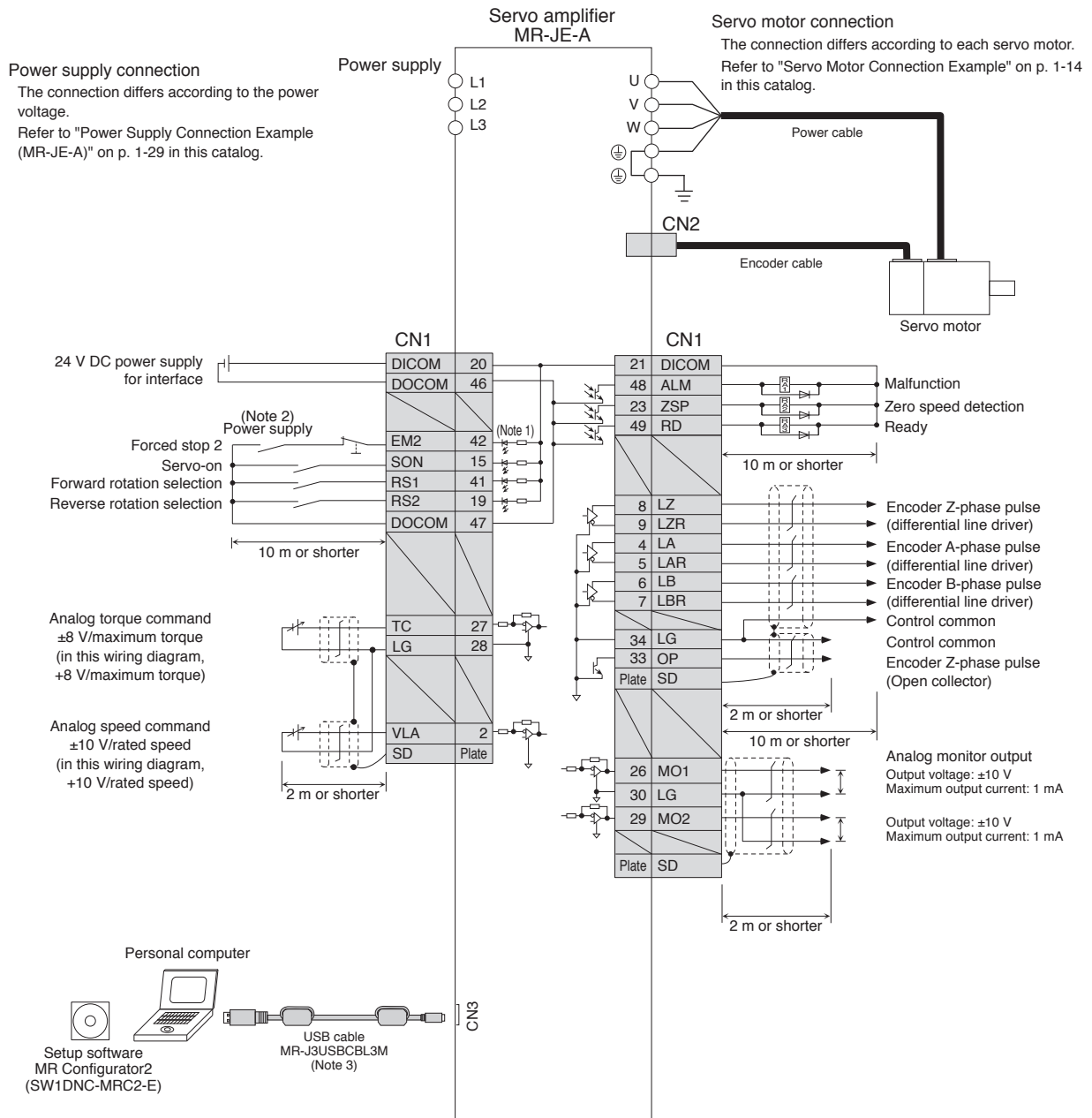

- Notes: 1. This is for sink wiring. Source wiring is also possible.  
 2. To prevent an unexpected restart of the servo amplifier, create a circuit to turn off EM2 (Forced stop 2) when the power is turned off.  
 3. USB and RS-422/RS-485 communication functions are mutually exclusive. Do not use them at the same time.



Be sure to read through Instruction Manual for the actual wiring and use. Use the equipment after you have a full knowledge of the equipment, safety information and instructions.

## MR-JE-A Standard Wiring Diagram Example: Point Table Method

A

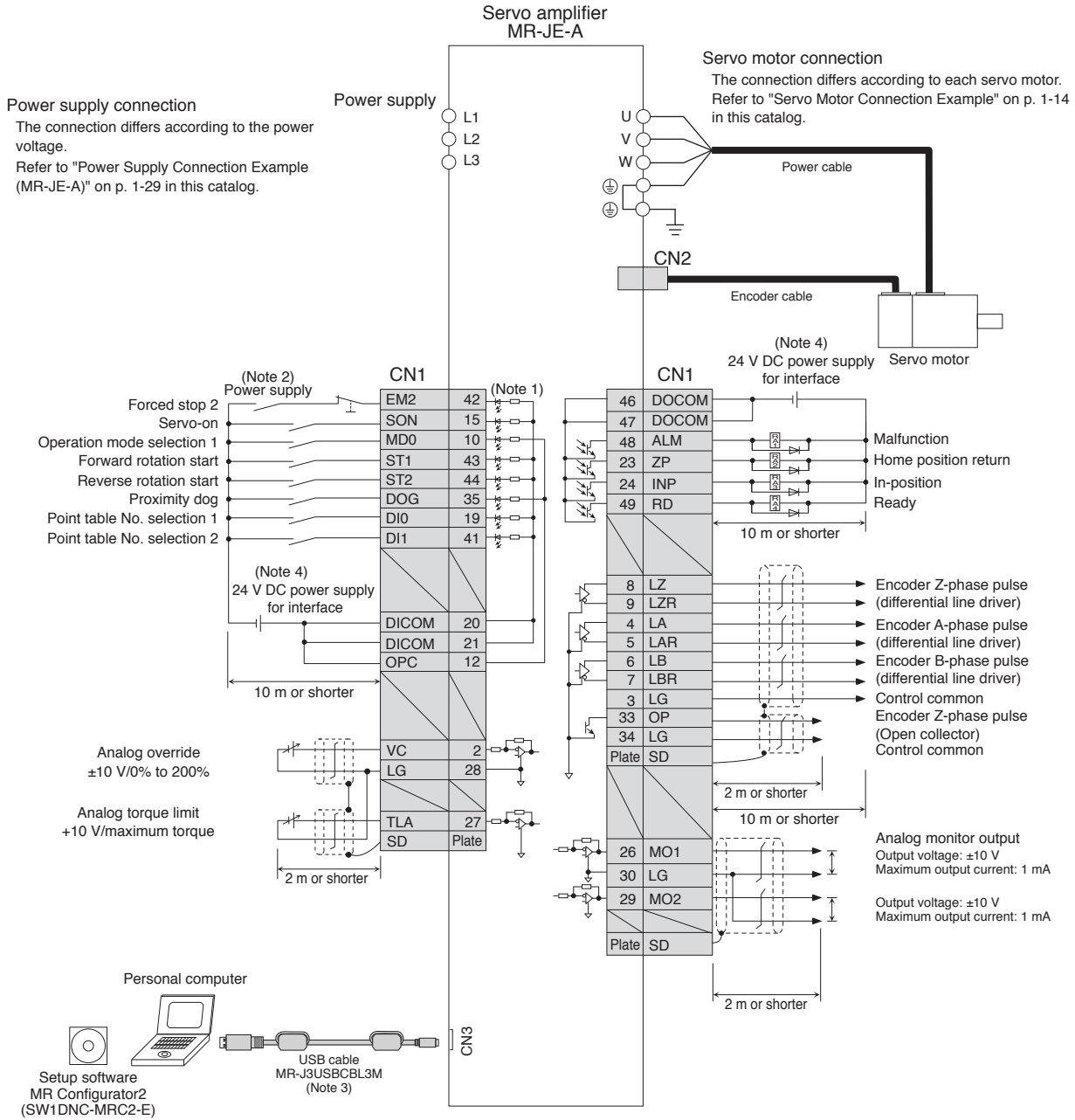

- Notes: 1. This is for sink wiring. Source wiring is also possible. However, when input devices are assigned to CN1-10 pin and CN1-35 pin, be sure to use sink wiring. Source wiring is not possible in this case. In the positioning mode, input devices are assigned in the initial setting. Refer to "MR-JE\_A Servo Amplifier Instruction Manual (Positioning Mode)" for details.
2. To prevent an unexpected restart of the servo amplifier, create a circuit to turn off EM2 (Forced stop 2) when the power is turned off.
3. USB and RS-422/RS-485 communication functions are mutually exclusive. Do not use them at the same time.
4. For convenience of illustration, the diagram shows separate 24 V DC power supplies for input and output signals. However, the input and output signals can share a common power supply.



Be sure to read through Instruction Manual for the actual wiring and use. Use the equipment after you have a full knowledge of the equipment, safety information and instructions.



MR-JE-A Standard Wiring Diagram Example: Program Methods

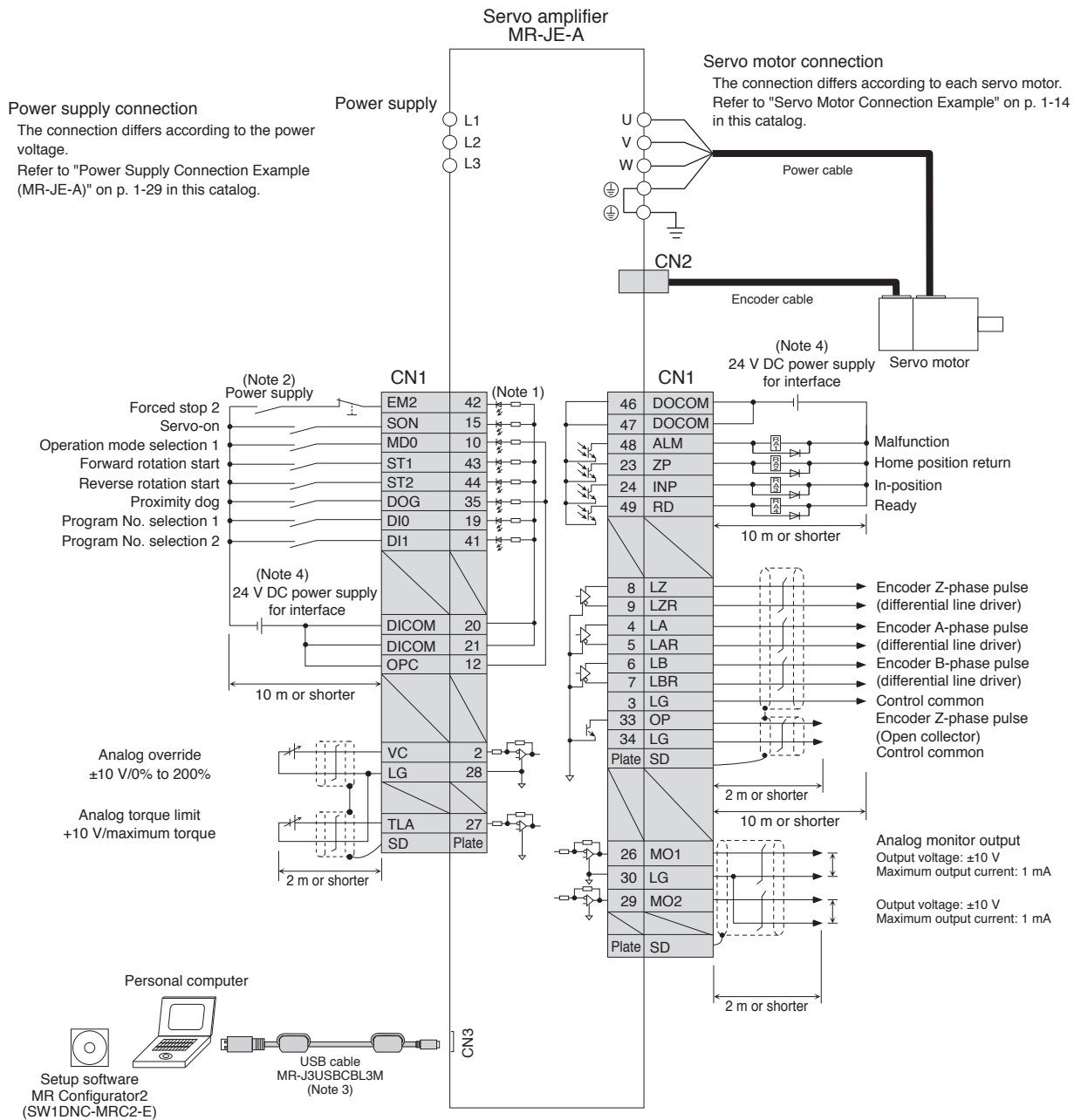

- Notes: 1. This is for sinking wiring. Source wiring is also possible. However, when input devices are assigned to CN1-10 pin and CN1-35 pin, be sure to use sinking wiring. Source wiring is not possible in this case. In the positioning mode, input devices are assigned in the initial setting. Refer to "MR-JE-A Servo Amplifier Instruction Manual (Positioning Mode)" for details.
2. To prevent an unexpected restart of the servo amplifier, create a circuit to turn off EM2 (Forced stop 2) when the power is turned off.
3. USB and RS-422/RS-485 communication functions are mutually exclusive. Do not use them at the same time.
4. For convenience of illustration, the diagram shows separate 24 V DC power supplies for input and output signals. However, the input and output signals can share a common power supply.

**!** Be sure to read through Instruction Manual for the actual wiring and use. Use the equipment after you have a full knowledge of the equipment, safety information and instructions.

Servo Amplifiers  
Servo Motors  
Options/Peripheral Equipment  
LVS/Wires  
Product List  
Cautions

# Servo Amplifiers

## Power Supply Connection Example (MR-JE-A)

A

● For 1-phase 200 V AC, 1 kW or smaller

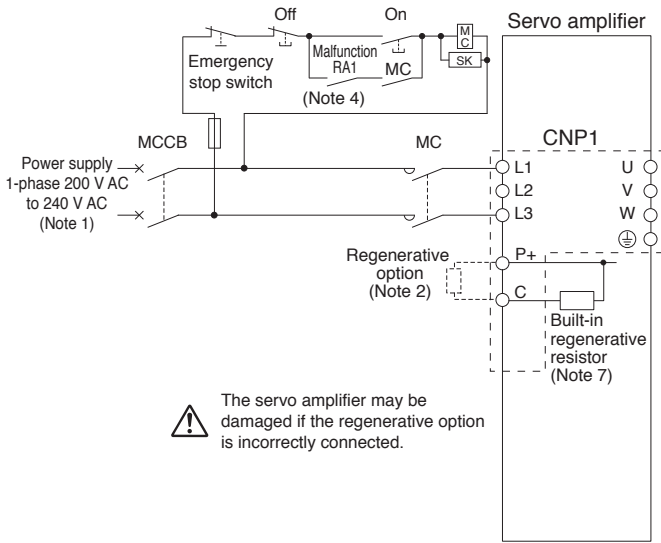

● For 3-phase 200 V AC, 1 kW or smaller

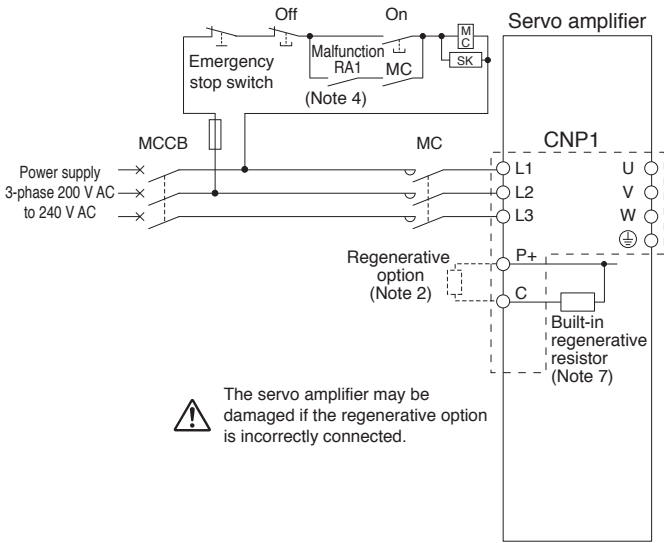

● For 1-phase 200 V AC, 2 kW

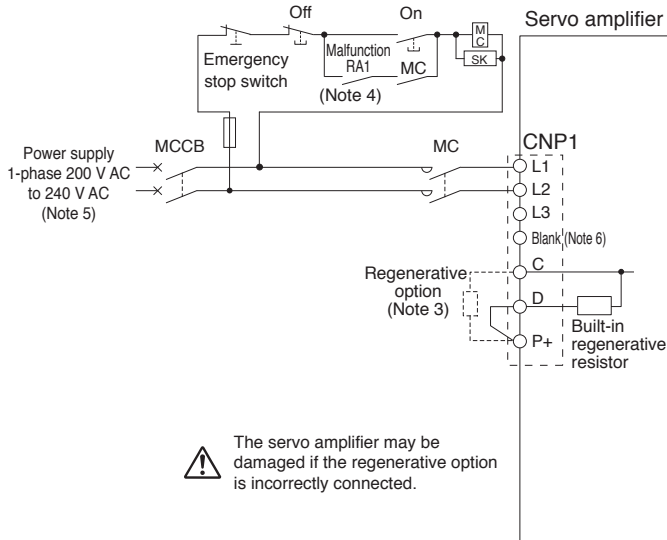

● For 3-phase 200 V AC, 2 kW and 3 kW

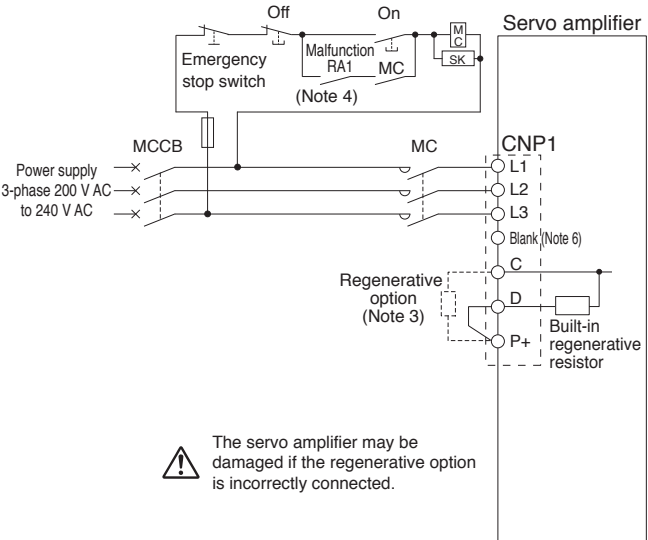

- Notes: 1. For 1-phase 200 V AC to 240 V AC, connect the power supply to L1 and L3 terminals. Do not connect anything to L2. The connections are different from MR-E Super series servo amplifiers. Be careful not to make a connection error when replacing MR-E Super with MR-JE.
2. Disconnect the wires for the built-in regenerative resistor (P+ and C), and remove the resistor when connecting the regenerative option externally.
3. Disconnect a short-circuit bar between P+ and D when connecting the regenerative option externally.
4. Create a power circuit to turn off the magnetic contactor when ALM (malfunction) is off (alarm occurrence).
5. For 1-phase 200 V AC to 240 V AC, connect the power supply to L1 and L2 terminals. Do not connect anything to L3.
6. The servo amplifiers manufactured in December 2016 or later do not have an N- terminal.
7. The servo amplifiers of 0.2 kW or smaller do not have a built-in regenerative resistor.



Be sure to read through Instruction Manual for the actual wiring and use. Use the equipment after you have a full knowledge of the equipment, safety information and instructions.

### RS-422 Serial Communication Connection Example

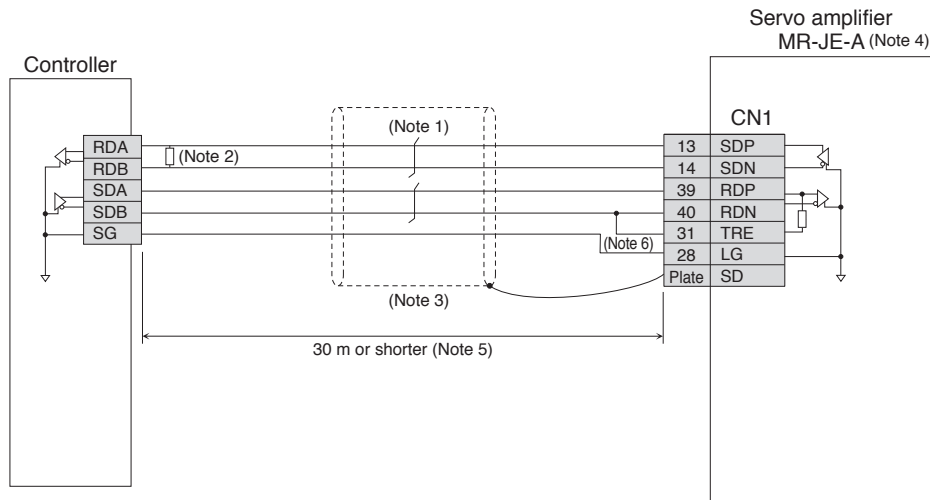

### RS-485 Serial Communication Connection Example

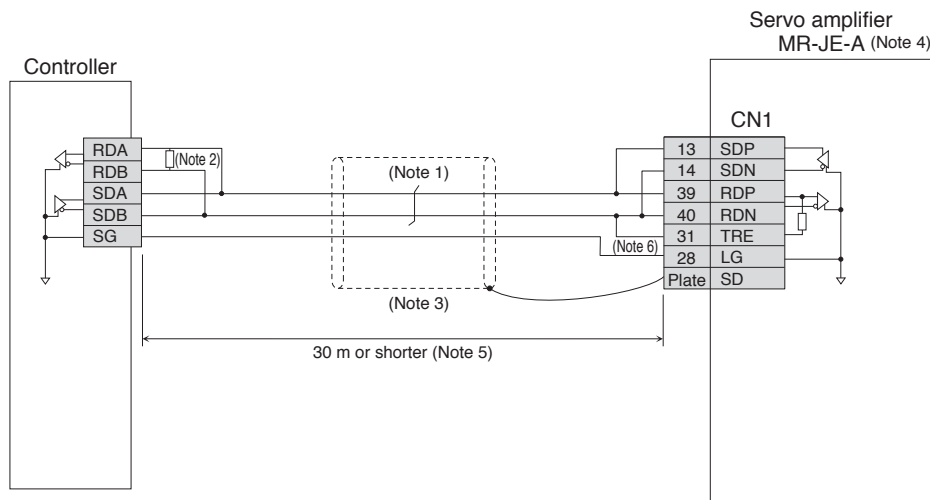

- Notes: 1. Twist the wires from SDP and SDN together, and RDP and PDN together.  
 2. Refer to the controller manual to connect a termination resistor. If a termination resistor is not specified, terminate with a 150 Ω resistor.  
 3. It is recommended that the cable be shielded.  
 4. RS-422 communication function is supported by the servo amplifiers manufactured on December 2013 or later. RS-485 communication function is available with the servo amplifiers manufactured on May 2015 or later. Refer to "MR-JE\_A Servo Amplifier Instruction Manual" for how to identify the manufacturing date of the products.  
 5. The cable length must be 30 m or shorter in a low-noise environment. When connecting multiple axes, also keep the overall length within 30 m.  
 6. Connect TRE and RDN for the servo amplifier of the final axis.



Be sure to read through Instruction Manual for the actual wiring and use. Use the equipment after you have a full knowledge of the equipment, safety information and instructions.

# Servo Amplifiers

A

## MR-JE-A Dimensions

- MR-JE-10A
- MR-JE-20A
- MR-JE-40A

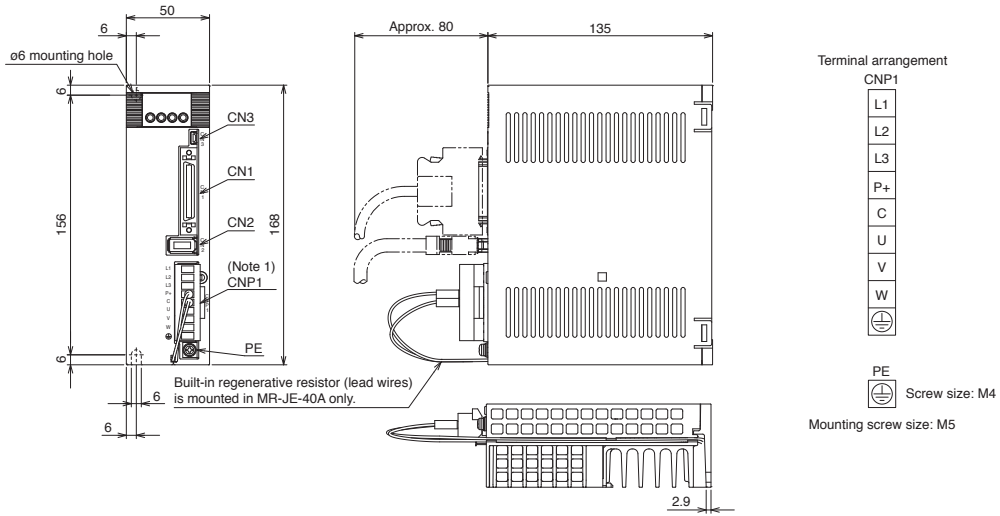

- MR-JE-70A
- MR-JE-100A

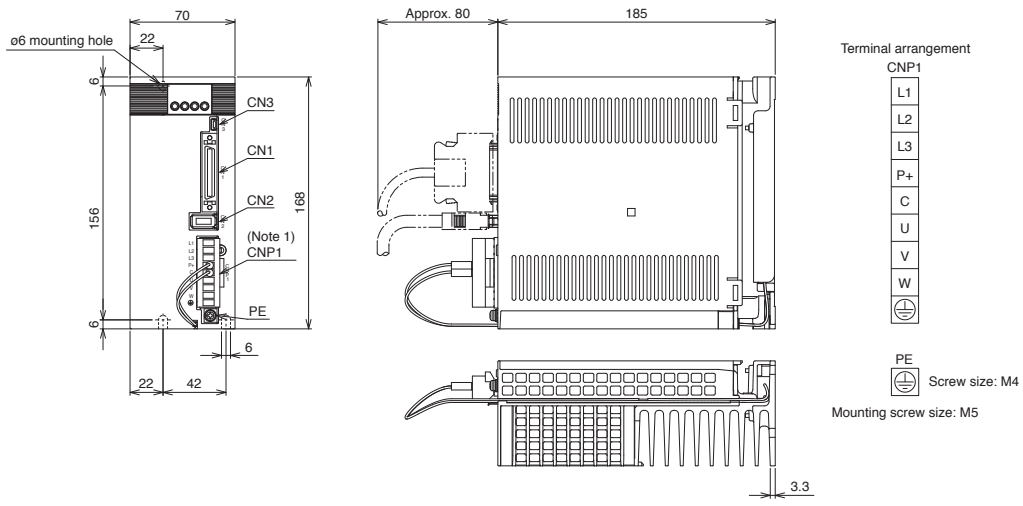

- MR-JE-200A
- MR-JE-300A

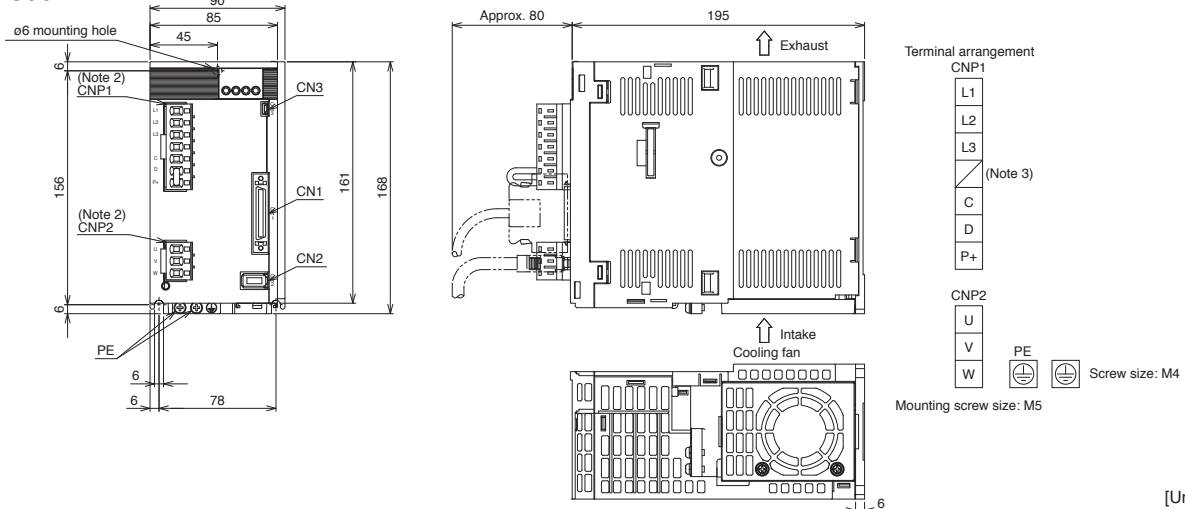

Notes: 1. CNP1 connector is supplied with the servo amplifier.  
2. CNP1 and CNP2 connectors are supplied with the servo amplifier.  
3. The servo amplifiers manufactured in December 2016 or later do not have an N-terminal.

## MR-JE-C Positioning Function: Point Table Method

Set the position and speed data to the point table, and select the point table No. with the command interface signal to start the positioning operation.

Item			Description	
Command method	Command interface		DI/O (Input: 7 points excluding EM2 (Forced stop 2), output: 3 points excluding ALM (Malfunction)), Ethernet/RS-485 communication <sup>(Note 2)</sup>	
	Operating specification		Positioning by specifying the point table No. (255 points when object/register is used, 15 points when DI is used) <sup>(Note 3)</sup>	
	Position command input <sup>(Note 1)</sup>	Absolute value command method	Set in the point table. Setting range of feed length per point: -999999 to 999999 [ $\times 10^{\text{STM}}$ $\mu\text{m}$ ], -99.9999 to 99.9999 [ $\times 10^{\text{STM}}$ inch], -999999 to 999999 [pulse]	
		Incremental value command method	Set in the point table. Setting range of feed length per point: 0 to 999999 [ $\times 10^{\text{STM}}$ $\mu\text{m}$ ], 0 to 99.9999 [ $\times 10^{\text{STM}}$ inch], 0 to 999999 [pulse]	
	Speed command input		Set the acceleration/deceleration time constants in the point table. Set the S-pattern acceleration/deceleration time constants with [Pr. PC03].	
	System		Signed absolute value command method/incremental value command method	
	Analog override		0 V DC to $\pm 10$ V DC/0% to 200%	
	Torque limit		Set by external analog input, parameters, or object/register (0 V DC to +10 V DC/maximum torque)	
	Position command data input	Communication <sup>(Note 1)</sup>	Absolute value command method	Set position command data with the object/register. Setting range of feed length per point: -999999 to 999999 [ $\times 10^{\text{STM}}$ $\mu\text{m}$ ], -99.9999 to 99.9999 [ $\times 10^{\text{STM}}$ inch], -999999 to 999999 [pulse]
			Incremental value command method	Set position command data with the object/register. Setting range of feed length per point: 0 to 999999 [ $\times 10^{\text{STM}}$ $\mu\text{m}$ ], 0 to 99.9999 [ $\times 10^{\text{STM}}$ inch], 0 to 999999 [pulse]
Speed command input		Select the speed and acceleration/deceleration time constants by communication. Set the S-pattern acceleration/deceleration time constants with [Pr. PC03].		
System		Signed absolute value command method/incremental value command method		
Operation mode	Automatic operation mode	Each positioning operation	Point table No. input Each positioning operation is executed based on the position/speed commands.	
		Automatic continuous positioning operation	Varying-speed operation (2 to 255 speeds)/ automatic continuous positioning operation (2 to 255 points)/ automatic continuous operation to the point table selected at start/ automatic continuous operation to the point table No. 1	
	Manual operation mode	JOG operation	Inching operation is executed with DI or serial communication function based on the speed command set with the parameter or object/register.	
		Manual pulse generator operation	Manual feeding is executed with a manual pulse generator. Command pulse multiplication: select from $\times 1$ , $\times 10$ , and $\times 100$ with a parameter.	
Home position return mode			Dog type, count type, data set type, stopper type, home position ignorance (servo on position as home position), dog type rear end reference, count type front end reference, dog cradle type, dog type adjacent Z-phase reference, dog type front end reference, dogless Z-phase reference, Homing on positive home switch and index pulse (method 3, 4), Homing on negative home switch and index pulse (method 5, 6), Homing on home switch and index pulse (method 7, 8, 11, 12), Homing without index pulse (method 19, 20, 21, 22, 23, 24, 27, 28), Homing on index pulse (method 33, 34), Homing on current position (method 35, 37)	
Automatic positioning to home position function			High-speed automatic positioning to a defined home position	
Other functions			Absolute position detection, backlash compensation, overtravel prevention with external limit switches (LSP/LSN), software stroke limit, touch probe function, override	

Notes: 1. STM is the ratio to the setting value of the position data. STM can be changed with [Pr. PT03].

2. RS-485 communication supports MODBUS<sup>®</sup> RTU protocol.

3. Up to four points of DO are available; therefore, PT0 (Point table No. output 1) to PT7 (Point table No. output 8) cannot be outputted simultaneously.

## MR-JE-A Positioning Function: Point Table Method

A

Set the position and speed data to the point table, and select the point table No. with the command interface signal to start the positioning operation.

Item			Description	
Command method	Command interface		DI/O (Input: 7 points excluding EM2 (Forced stop 2), output: 3 points excluding ALM (Malfunction)), RS-422/RS-485 communication <sup>(Note 2)</sup>	
	Operating specification		Positioning by specifying the point table No. (31 points when communication is specified, 15 points when DI is used)	
	Position command input <sup>(Note 1)</sup>	Absolute value command method	Set in the point table. Setting range of feed length per point: -999999 to 999999 [ $\times 10^{\text{STM}}$ $\mu\text{m}$ ], -99.9999 to 99.9999 [ $\times 10^{\text{STM}}$ inch], -999999 to 999999 [pulse], Setting range of rotation angle: -360.000 to 360.000 [degree]	
		Incremental value command method	Set in the point table. Setting range of feed length per point: 0 to 999999 [ $\times 10^{\text{STM}}$ $\mu\text{m}$ ], 0 to 99.9999 [ $\times 10^{\text{STM}}$ inch], 0 to 999999 [pulse], Setting range of rotation angle: 0 to 999.999 [degree]	
	Speed command input		Set the acceleration/deceleration time constants in the point table. Set the S-pattern acceleration/deceleration time constants with [Pr. PC03].	
	System		Signed absolute value command method/incremental value command method	
	Analog override		0 V DC to $\pm 10$ V DC/0% to 200%	
	Torque limit		Set by parameters or external analog input (0 V DC to +10 V DC/maximum torque)	
	Position command data input	RS-422/RS-485 communication	Position command input <sup>(Note 1)</sup>	Absolute value command method Set position command data with RS-422/RS-485 communication. Setting range of feed length per point: -999999 to 999999 [ $\times 10^{\text{STM}}$ $\mu\text{m}$ ], -99.9999 to 99.9999 [ $\times 10^{\text{STM}}$ inch], -999999 to 999999 [pulse], Setting range of rotation angle: -360.000 to 360.000 [degree]
			Incremental value command method Set position command data with RS-422/RS-485 communication. Setting range of feed length per point: 0 to 999999 [ $\times 10^{\text{STM}}$ $\mu\text{m}$ ], 0 to 99.9999 [ $\times 10^{\text{STM}}$ inch], 0 to 999999 [pulse], Setting range of rotation angle: 0 to 999.999 [degree]	
Speed command input		Select the speed and acceleration/deceleration time constants by RS-422/RS-485 communication. Set the S-pattern acceleration/deceleration time constants with [Pr. PC03].		
System		Signed absolute value command method/incremental value command method		
Operation mode	Automatic operation mode	Each positioning operation	Point table No. input, position data input method Each positioning operation is executed based on the position/speed commands.	
		Automatic continuous positioning operation	Varying-speed operation (2 to 31 speeds)/ automatic continuous positioning operation (2 to 31 points)/ automatic continuous operation to the point table selected at start/ automatic continuous operation to the point table No. 1	
	Manual operation mode	JOG operation	Inching operation is executed with DI or serial communication function <sup>(Note 2)</sup> based on the speed command set with the parameter.	
Manual pulse generator operation		Manual feeding is executed with a manual pulse generator. Command pulse multiplication: select from $\times 1$ , $\times 10$ , and $\times 100$ with a parameter.		
Home position return mode			Dog type, count type, data set type, stopper type, home position ignorance (servo-on position as home position), dog type rear end reference, count type front end reference, dog cradle type, dog type adjacent Z-phase reference, dog type front end reference, dogless Z-phase reference	
Automatic positioning to home position function			High-speed automatic positioning to a defined home position	
Other functions			Backlash compensation, overtravel prevention with external limit switches (LSP/LSN), teaching function, roll feed display function, software stroke limit, mark detection (current position latch/interrupt positioning/mark sensor input compensation), simple cam function, encoder following function, command pulse input through function, override	

Notes: 1. STM is the ratio to the setting value of the position data. STM can be changed with [Pr. PT03].

2. RS-422 communication supports Mitsubishi Electric general-purpose AC servo protocol.

RS-485 communication supports Mitsubishi Electric general-purpose AC servo protocol and MODBUS® RTU protocol.

MR-JE-C/MR-JE-A Positioning Function: Point Table Method

C A

Absolute value command method: travels to a specified address (absolute value) with reference to the home position

Item	Setting range	Description
Point table No.	MR-JE-C 1 to 255 (when object/register is used) 1 to 15 (when DI is used) MR-JE-A 1 to 31 (when communication is specified) 1 to 15 (when DI is used)	Specify a point table in which a target position, servo motor speed, acceleration/deceleration time constants, dwell, and sub function will be set.
Target position (Note 1, 2) (position data)	-999999 to 999999 [ $\times 10^{\text{STM}}$ $\mu\text{m}$ ] -99.9999 to 99.9999 [ $\times 10^{\text{STM}}$ inch] -360.000 to 360.000 [degree] (Note 3) -999999 to 999999 [pulse]	Set a travel distance. (1) When using as absolute value command method Set a target address (absolute value). (2) When using as incremental value command method Set a travel distance. Reverse rotation command is applied with a minus sign.
Servo motor speed	0 to permissible speed [r/min]	Set a command speed for the servo motor in positioning.
Acceleration time constant	0 to 20000 [ms]	Set a time period for the servo motor to reach the rated speed.
Deceleration time constant	0 to 20000 [ms]	Set a time period for the servo motor to decelerate from the rated speed to a stop.
Dwell	0 to 20000 [ms]	Set dwell. When the dwell is set, the position command for the next point table will be started after the position command for the selected point table is completed and the set dwell is passed. The dwell is disabled when 0 or 2 is set for the sub function. Varying-speed operation is enabled when 1, 3, 8, 9, 10, or 11 is set for the sub function and when 0 is set for the dwell.
Sub function	0 to 3, and 8 to 11	Set sub function. (1) When using the point table with the absolute value command method 0: Automatic operation for a selected point table is performed. 1: Automatic continuous operation is performed without a stop to the next point table. 8: Automatic continuous operation is performed without a stop to the point table selected at startup. 9: Automatic continuous operation of the point table No. 1 is performed without a stop. (2) When using this point table with the incremental value command method 2: Automatic operation for a selected point table is performed. 3: Automatic continuous operation is performed without a stop to the next point table. 10: Automatic continuous operation for a point table selected at startup is performed. 11: Automatic continuous operation of the point table No. 1 is performed without a stop.
M code (Note 5)	0 to 99	Set a code to be outputted when the positioning completes.

Example of setting point table data

Point table No.	Target position (position data) [ $\times 10^{\text{STM}}$ $\mu\text{m}$ ] (Note 2)	Servo motor speed [r/min]	Acceleration time constant [ms]	Deceleration time constant [ms]	Dwell [ms]	Sub function	M code (Note 5)
1	1000	2000	200	200	0	*	1
2	2000	1600	100	100	0	0	2
:	:	:	:	:	:	:	:
255 (Note 4)	3000	3000	100	100	0	2	99

\* The operation of the next point table is set with the sub function.

● When the sub function is set to 0:

Start signal is required for each point table.

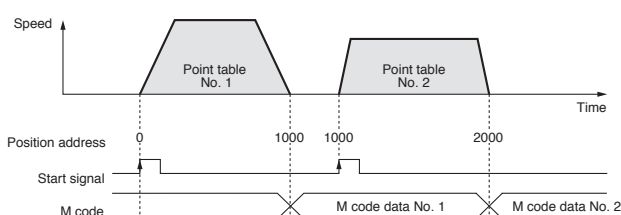

● When the sub function is set to 1:

Automatic continuous operation is executed based on the point table.

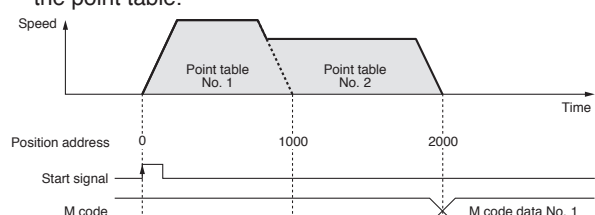

Notes: 1. Change the unit to  $\mu\text{m}$ /inch/degree/pulse with [Pr. PT01].  
2. STM is the ratio to the setting value of the position data. STM can be changed with [Pr. PT03].  
3. Supported only by MR-JE-A.  
4. For MR-JE-A, up to 31 point tables are available.  
5. MR-JE-C supports M code with the communication function. MR-JE-A does not support M code. Refer to "MR-JE-C Servo Amplifier Instruction Manual (Network)" for details.

## MR-JE-C/MR-JE-A Positioning Function: Point Table Method

C A

Incremental value command method: travels from a current position based on the set position data

Item	Setting range	Description
Point table No.	MR-JE-C 1 to 255 (when object/register is used) 1 to 15 (when DI is used) MR-JE-A 1 to 31 (when communication is specified) 1 to 15 (when DI is used)	Specify a point table in which a target position, servo motor speed, acceleration/deceleration time constants, dwell, and sub function will be set.
Target position (position data) <small>(Note 1, 2)</small>	0 to 999999 [ $\times 10^{\text{STM}}$ $\mu\text{m}$ ] 0 to 99.9999 [ $\times 10^{\text{STM}}$ inch] 0 to 999.999 [degree] <small>(Note 3)</small> 0 to 999999 [pulse]	Set a travel distance. Operation starts with ST1 (Forward rotation start) or ST2 (Reverse rotation start).
Servo motor speed	0 to permissible speed [r/min]	Set a command speed for the servo motor in positioning.
Acceleration time constant	0 to 20000 [ms]	Set a time period for the servo motor to reach the rated speed.
Deceleration time constant	0 to 20000 [ms]	Set a time period for the servo motor to decelerate from the rated speed to a stop.
Dwell	0 to 20000 [ms]	Set a dwell. When the dwell is set, the position command for the next point table will be started after the position command for the selected point table is completed and the set dwell is passed. The dwell is disabled when 0 is set for the sub function. Varying-speed operation is enabled when 1, 8, or 9 is set for the sub function and when 0 is set for the dwell.
Sub function	0, 1, 8, and 9	Set sub function. 0: Automatic operation for a selected point table is performed. 1: Automatic continuous operation is performed without a stop to the next point table. 8: Automatic continuous operation is performed without a stop to the point table selected at startup. 9: Automatic continuous operation of the point table No. 1 is performed without a stop.
M code <small>(Note 5)</small>	0 to 99	Set a code to be outputted when the positioning completes.

### Example of setting point table data

Point table No.	Target position (position data) [ $\times 10^{\text{STM}}$ $\mu\text{m}$ ] <small>(Note 2)</small>	Servo motor speed [r/min]	Acceleration time constant [ms]	Deceleration time constant [ms]	Dwell [ms]	Sub function	M code <small>(Note 5)</small>
1	1000	2000	200	200	0	*	1
2	1000	1600	100	100	0	0	2
:	:	:	:	:	:	:	:
255 <small>(Note 4)</small>	3000	3000	100	100	0	0	99

### \* The operation of the next point table is set with the sub function.

#### ● When the sub function is set to 0:

Start signal is required for each point table.

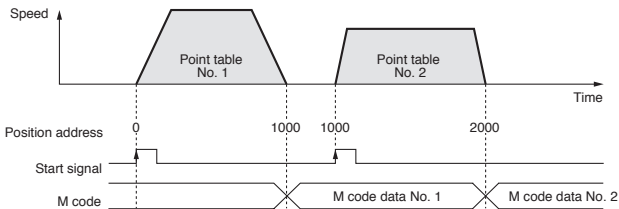

#### ● When the sub function is set to 1:

Automatic continuous operation is executed based on the point table.

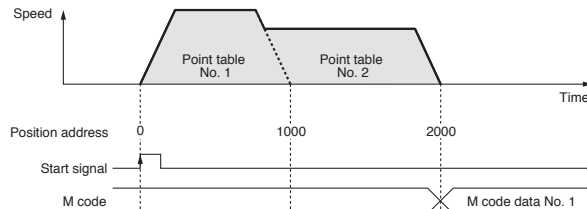

Notes: 1. Change the unit to  $\mu\text{m}$ /inch/degree/pulse with [Pr. PT01].

2. STM is the ratio to the setting value of the position data. STM can be changed with [Pr. PT03].

3. Supported only by MR-JE-A.

4. For MR-JE-A, up to 31 point tables are available.

5. MR-JE-C supports M code with the communication function. MR-JE-A does not support M code. Refer to "MR-JE-C Servo Amplifier Instruction Manual (Network)" for details.



### MR-JE-A Positioning Function: Program Method

Create program including the position data, the servo motor speed, and the acceleration/deceleration time constants, and select the program No. with the command interface signals to start the positioning operation. The program method enables more complex positioning operation than the point table method. MR Configurator2 is required to create programs.

Item		Description	
Command method	Command interface	DI/O (Input: 7 points excluding EM2 (Forced stop 2), output: 3 points excluding ALM (Malfunction)), RS-422 communication/RS-485 communication <sup>(Note 2)</sup>	
	Operating specification	Program language (program with MR Configurator2) Program capacity: 480 steps Program points: 16	
	Position command input <sup>(Note 1)</sup>	Absolute value command method	Set with program language. Setting range of feed length: -999999 to 999999 [ $\times 10^{\text{STM}}$ $\mu\text{m}$ ], -99.9999 to 99.9999 [ $\times 10^{\text{STM}}$ inch], -999999 to 999999 [pulse], Setting range of rotation angle: -360.000 to 360.000 [degree]
		Incremental value command method	Set with program language. Setting range of feed length: -999999 to 999999 [ $\times 10^{\text{STM}}$ $\mu\text{m}$ ], -99.9999 to 99.9999 [ $\times 10^{\text{STM}}$ inch], -999999 to 999999 [pulse], Setting range of rotation angle: -999.999 to 999.999 [degree]
	Speed command input	Set servo motor speed, acceleration/deceleration time constants, S-pattern acceleration/deceleration time constants with program language. S-pattern acceleration/deceleration time constants are also settable with [Pr. PC03].	
	System	Signed absolute value command method/signed incremental value command method	
	Analog override	0 V DC to $\pm 10$ V DC/0% to 200%	
	Torque limit	Set by parameters or external analog input (0 V DC to +10 V DC/maximum torque)	
Operation mode	Automatic operation mode	Program Depends on the setting of the program language	
	Manual operation mode	JOG operation	Inching operation is executed with DI or serial communication function <sup>(Note 2)</sup> based on the speed commands set with a parameter.
		Manual pulse generator operation	Manual feeding is executed with a manual pulse generator. Command pulse multiplication: select from $\times 1$ , $\times 10$ , and $\times 100$ with a parameter.
Home position return mode		Dog type, count type, data set type, stopper type, home position ignorance (servo-on position as home position), dog type rear end reference, count type front end reference, dog cradle type, dog type adjacent Z-phase reference, dog type front end reference, dogless Z-phase reference	
Other functions		Backlash compensation, overtravel prevention with external limit switches (LSP/LSN), roll feed display function, software stroke limit, mark detection (current position latch/interrupt positioning/mark sensor input compensation), simple cam function, encoder following function, command pulse input through function, override	

Notes: 1. STM is the ratio to the setting value of the position data. STM can be changed with [Pr. PT03].

2. RS-422 communication supports Mitsubishi Electric general-purpose AC servo protocol.

RS-485 communication supports Mitsubishi Electric general-purpose AC servo protocol and MODBUS<sup>®</sup> RTU protocol.

## MR-JE-A Positioning Function: Program Method

A

### Command List

Command	Name	Setting range	Description
SPN(setting value) (Note 2)	Servo motor speed	0 to instantaneous permissible speed [r/min]	Set a command speed for the servo motor in positioning. Do not set a value exceeding the instantaneous permissible speed of the servo motor.
STA(setting value) (Note 2)	Acceleration time constant	0 to 20000 [ms]	Set acceleration time constant. The setting value is a time period that the servo motor reaches the rated speed from a stop.
STB(setting value) (Note 2)	Deceleration time constant	0 to 20000 [ms]	Set deceleration time constant. The setting value is a time period that the servo motor stops from the rated speed.
STC(setting value) (Note 2)	Acceleration/ deceleration time constants	0 to 20000 [ms]	Set acceleration and deceleration time constants. The setting value is a time period that the servo motor reaches the rated speed from a stop and stops from the rated speed.
STD(setting value) (Note 2)	S-pattern acceleration/ deceleration time constants	0 to 1000 [ms]	Set S-pattern acceleration/deceleration time constants.
MOV(setting value) (Note 4, 5)	Absolute value travel command	-999999 to 999999 [ $\times 10^{\text{STM}}$ $\mu\text{m}$ ] -99.9999 to 99.9999 [ $\times 10^{\text{STM}}$ inch]	Travels based on the value set as an absolute value.
MOVA(setting value) (Note 4, 5)	Absolute value continuous travel command	-360.000 to 360.000 [degree] -999999 to 999999 [pulse]	Travels continuously based on the value set as an absolute value. Be sure to write this command after [MOV] command.
MOVI(setting value) (Note 4, 5)	Incremental value travel command	-999999 to 999999 [ $\times 10^{\text{STM}}$ $\mu\text{m}$ ] -99.9999 to 99.9999 [ $\times 10^{\text{STM}}$ inch]	Travels based on the value set as an incremental value.
MOVIA(setting value) (Note 4, 5)	Incremental value continuous travel command	-999.999 to 999.999 [degree] -999999 to 999999 [pulse]	Travels continuously based on the value set as an incremental value. Be sure to write this command after [MOVI] command.
SYNC(setting value) (Note 1)	Waiting for external signal to switch on	1 to 3	Stops the next step until PI1 (Program input 1) to PI3 (Program input 3) turn on after SOUT (SYNC synchronous output) is outputted.
OUTON(setting value) (Note 1)	External signal on output	1 to 3	Turns on OUT1 (Program output 1) to OUT3 (Program output 3).
OUTOF(setting value) (Note 1)	External signal off output	1 to 3	Turns off OUT1 (Program output 1) to OUT3 (Program output 3) which were turned on with [OUTON] command.
TRIP(setting value) (Note 1, 4, 5)	Absolute value trip point specification	-999999 to 999999 [ $\times 10^{\text{STM}}$ $\mu\text{m}$ ] -99.9999 to 99.9999 [ $\times 10^{\text{STM}}$ inch] -360.000 to 360.000 [degree] -999999 to 999999 [pulse]	Executes the next step after [MOV] or [MOVA] commands are started and then the servo motor moves for the travel amount set in [TRIP] command. Be sure to write this command after [MOV] or [MOVA] command.
TRIP1(setting value) (Note 1, 4, 5)	Incremental value trip point specification	-999999 to 999999 [ $\times 10^{\text{STM}}$ $\mu\text{m}$ ] -99.9999 to 99.9999 [ $\times 10^{\text{STM}}$ inch] -999.999 to 999.999 [degree] -999999 to 999999 [pulse]	Executes the next step after [MOVI] or [MOVIA] commands are started and then the servo motor moves for the travel amount set in [TRIP1] command. Be sure to write this command after [MOVI] or [MOVIA] command.
ITP(setting value) (Note 1, 3, 4, 5)	Interrupt positioning	0 to 999999 [ $\times 10^{\text{STM}}$ $\mu\text{m}$ ] 0 to 99.9999 [ $\times 10^{\text{STM}}$ inch] 0 to 999.999 [degree] 0 to 999999 [pulse]	Stops the operation after the servo motor moves for the travel amount set when the interrupt signal is inputted. Be sure to write this command after [SYNC] command.
COUNT(setting value) (Note 1)	External pulse count	-999999 to 999999 [pulse]	Executes the next step when the value of the pulse counter exceeds the count value set in [COUNT] command. [COUNT (0)] clears the pulse counter to zero.
FOR(setting value) NEXT	Step repeat command	0, and 1 to 10000 [number of times]	Repeats the steps between [FOR(setting value)] and [NEXT] commands for the number of times set. Repeats endlessly with [FOR(0) NEXT].
LPOS (Note 1)	Current position latch	-	Latches the current position with the rising edge of the LPS signal. The latched current position data can be read with the communication command.
TIM(setting value)	Dwell	1 to 20000 [ms]	Waits for the next step until the set time passes.
ZRT	Home position return	-	Executes a manual home position return.
TIMES(setting value)	Program count command	0, and 1 to 10000 [number of times]	Set the number of program execution by writing [TIMES (setting value)] command in the first line of the program. The setting is not required for executing once. Repeats endlessly with [TIMES(0)].
STOP	Program stop	-	Stops the program in execution. Be sure to write this command in the final line.

Notes: 1. [SYNC], [OUTON], [OUTOF], [TRIP], [TRIP1], [ITP], [COUNT], and [LPOS] commands are valid while the commands are outputted.

2. [SPN] command is valid while [MOV], [MOVA], [MOVI], or [MOVIA] commands are in execution. [STA], [STB], [STC], and [STD] commands are valid while [MOV] or [MOVI] command is in execution.

3. [ITP] command will be skipped to the next step when the remaining distance equals to or less than the setting value, when the servo motor is not running, or when the servo motor is decelerating.

4. Change the unit to  $\mu\text{m}/\text{inch}/\text{degree}/\text{pulse}$  with [Pr. PT01].

5. STM is the ratio to the setting value of the position data. STM can be changed with [Pr. PT03].

## MR-JE-A Positioning Function: Program Method

### Command list

Command	Name	Setting range	Description
TLP(setting value)	Forward rotation torque limit	0, and 1 to 1000 [0.1%]	Limits the torque generated by the servo motor running in CCW and regenerating in CW, as the maximum torque is 100%. The setting remains valid until the program is stopped. [TLP(0)] enables the setting of [Pr. PA11].
TLN(setting value)	Reverse rotation torque limit	0, and 1 to 1000 [0.1%]	Limits the torque generated by the servo motor running in CW and regenerating in CCW, as the maximum torque is 100%. The setting remains valid until the program is stopped. [TLN(0)] enables the setting of [Pr. PA12].
TQL(setting value)	Torque limit	0, and 1 to 1000 [0.1%]	Limits the torque generated by the servo motor, as the maximum torque is 100%. The setting remains valid until the program is stopped. [TQL(0)] enables the settings of [Pr. PA11] and [Pr. PA12].

### Program example 1

The following is an example of executing two types of operations with the same servo motor speed and acceleration/deceleration time constants but the different travel commands.

Step	Program (Note 1)	Description
(1)	SPN(3000)	Servo motor speed: 3000 [r/min]
(2)	STA(200)	Acceleration time constant: 200 [ms]
(3)	STB(300)	Deceleration time constant: 300 [ms]
(4)	MOV(1000)	Absolute value travel command: 1000 [ $\times 10^{STM} \mu\text{m}$ ]
(5)	TIM(100)	Dwell: 100 [ms]
(6)	MOV(2500)	Absolute value travel command: 2500 [ $\times 10^{STM} \mu\text{m}$ ]
(7)	STOP	Program stop

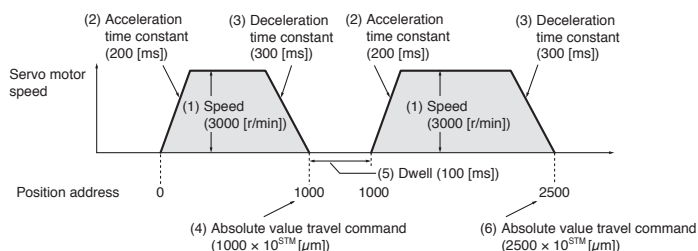

### Program example 2

The following is an example of repeating the steps between [FOR(setting value)] and [NEXT] commands for the number of times set.

Step	Program (Note 1)	Description
(1)	SPN(3000)	Servo motor speed: 3000 [r/min]
(2)	STC(20)	Acceleration/deceleration time constants: 20 [ms]
(3)	MOV(1000)	Absolute value travel command: 1000 [ $\times 10^{STM} \mu\text{m}$ ]
(4)	TIM(100)	Dwell: 100 [ms]
(5)	FOR(3)	Starting the step repeat command: 3 [number of times]
(6)	MOVI(100)	Incremental value travel command: 100 [ $\times 10^{STM} \mu\text{m}$ ]
(7)	TIM(100)	Dwell: 100 [ms]
(8)	NEXT	Ending the step repeat command
(9)	STOP	Program stop

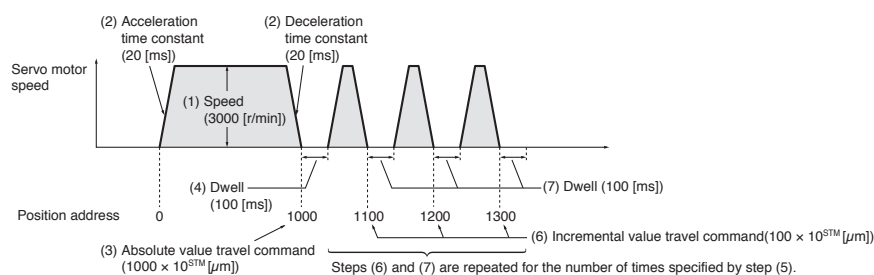

Notes: 1. The values in [SPN], [STA], [STB], and [STC] commands remains valid until they are reset. The values will not be initialized at the start of the program. The settings are also valid in other programs.

## MR-JE-C Positioning Function: Indexer Method

C

Positioning is executed in accordance with the specified stations (maximum of 255 stations).

The servo amplifier automatically calculates the travel distance from the number of stations and gear teeth in the machine and servo motor sides set in the parameters.

item		Description	
Command method	Command interface	DI/O (Input: 7 points excluding EM2 (Forced stop 2), output: 3 points excluding ALM (Malfunction)), Ethernet/RS-485 communication <sup>(Note 1)</sup>	
	Operating specification	Positioning in accordance with the specified stations (255 divisions when object/register is used, 16 divisions when DI is used)	
	Speed command input	Set the speed and acceleration/deceleration time constants with input signal or object/register.	
	System	Rotation direction specifying indexer/shortest rotating indexer.	
	Digital override	Select the override multiplying factor by input signal or object/register.	
	Torque limit	Set by external analog input, parameters or object/register (0 V DC to +10 V DC/maximum torque).	
Operation mode	Automatic operation mode	Rotation direction specifying indexer	Positions to the specified station. Rotation direction settable
		Shortest rotating indexer	Positions to the specified station. Rotates in the shorter direction from the current position.
	Manual operation mode	JOG operation	Decelerates to a stop regardless of the station.
		Station JOG operation	Rotates in a direction specified by the rotation direction decision when the start signal turns on. Positions to the nearest station where the servo motor can decelerate to a stop when the start signal turns off.
Home position return mode		Torque limit changing dog type, Torque limit changing data set type, Homing on current position (Method 35, 37)	
Other functions		Absolute position detection, backlash compensation, overtravel prevention with external limit switches (LSP/LSN), software stroke limit, touch probe function, override	

Notes: 1. RS-485 communication supports MODBUS® RTU protocol.

## MR-JE-C Positioning Function: Indexer Method

### Rotation direction specifying indexer

In the rotation direction specifying indexer, the servo motor always rotates in a definite direction.

Turn off MD0 (Operation mode selection 1), and turn on MD1 (Operation mode selection 2). The servo motor moves in the station No. decreasing direction with SIG (Rotation direction decision) off, and in the increasing direction with SIG on. When ST1 (Forward rotation start) turns on, the travel amount will be calculated from the current position and the next station position, and then the positioning will be executed to the direction specified by the rotation direction decision.

The following timing chart is an example of the operation executed from the station No. 0 where the servo motor is stopped at servo-on.

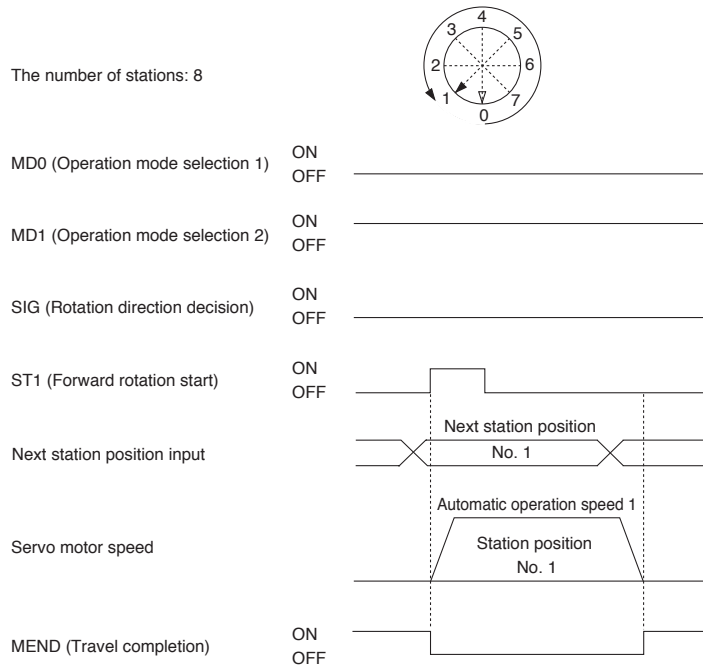

### Shortest rotating indexer

In the shortest rotating indexer, the servo motor automatically rotates in the shorter direction.

Turn on both MD0 (Operation mode selection 1) and MD1 (Operation mode selection 2). When ST1 (Forward rotation start) turns on, the travel amount will be calculated from the current position and the next station position, and then the positioning will be executed in the shorter direction.

The following timing chart is an example of the operation executed from the station No. 0 where the servo motor is stopped at servo-on.

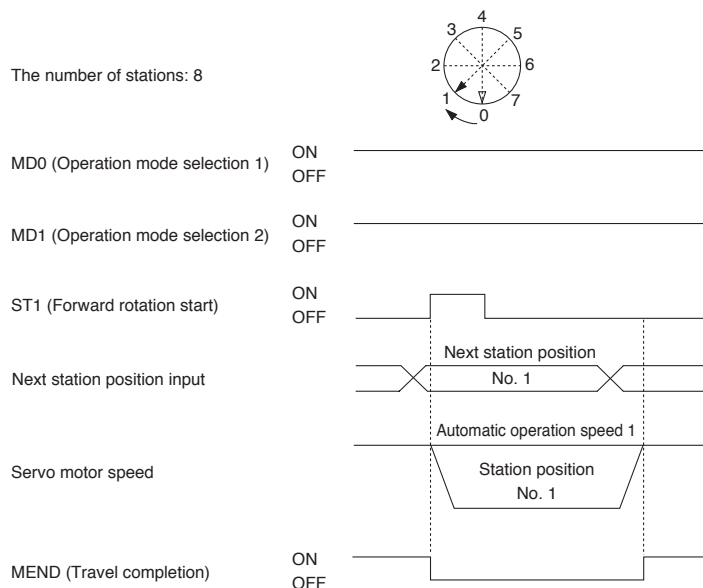

# Servo Amplifiers

## MODBUS<sup>®</sup>/TCP Specifications

C

MODBUS<sup>®</sup>/TCP is a protocol that enables MODBUS<sup>®</sup> messages to be used with Ethernet communication.

Item	Specifications
Communication protocol	MODBUS <sup>®</sup> /TCP protocol <sup>(Note 1)</sup>
Compliance with standards	OPEN MODBUS <sup>®</sup> /TCP SPECIFICATION
Port No.	No. 502
IP address	IPv4 range: 0.0.0.0 to 255.255.255.255 Use the same network address for both a client and servers. Default value: 192.168.3.0
Subnet mask	Default value (recommended): 255.255.255.0
Message format	Refer to "MR-JE- _C Servo Amplifier Instruction Manual (Network)" for communication functions.
Physical layer	100BASE-TX
Communication connector	RJ45, 1 port (CN1)
Communication cable	CAT5e, shielded twisted pair (4 pair) straight cable
Network topology	Star
Variable communication speed	100 Mbps
Transmission distance between stations	Maximum 100 m
Waiting time setting	None
Maximum number of connections	3
Server function	Number of request messages that are receivable simultaneously 1

## MODBUS<sup>®</sup> RTU Specifications

C

A

Item	Specifications	
Communication protocol	MODBUS <sup>®</sup> RTU protocol <sup>(Note 2)</sup>	
Compliance with standards	EIA-485 (RS-485)	
Numbers connected	1:n (maximum 32) Set stations 1 to 247 by a parameter. (Station 0 is for broadcast communication.)	
Communication baud rate [bps]	4800/9600/19200/38400/57600/115200 (set by a parameter)	
Control process	Asynchronous system	
Communication method	Half duplex/full duplex <sup>(Note 3)</sup>	
Maximum overall extension distance [m]	30	
Communication specifications	Character method	Binary (8-bit fixed)
	Start bit	1-bit
	Stop bit length	Select from the following by a parameter. • Even parity, stop bit length 1-bit (initial value) • Odd parity, stop bit length 1-bit • No parity, stop bit length 2-bit
	Parity check	
	Error check	CRC-16 method
Terminator	None	
Waiting time setting	None	
Master/Slave classification	Slave	

Notes: 1. MODBUS<sup>®</sup>/TCP is supported by MR-JE-C with software version A3 or later.

2. MODBUS<sup>®</sup> RTU is supported by MR-JE-C with software version A4 or later and MR-JE-A.

3. MR-JE-C does not support full duplex.

### MODBUS® RTU Wiring

C A

Up to 32 servo amplifier axes can be operated on the same bus.

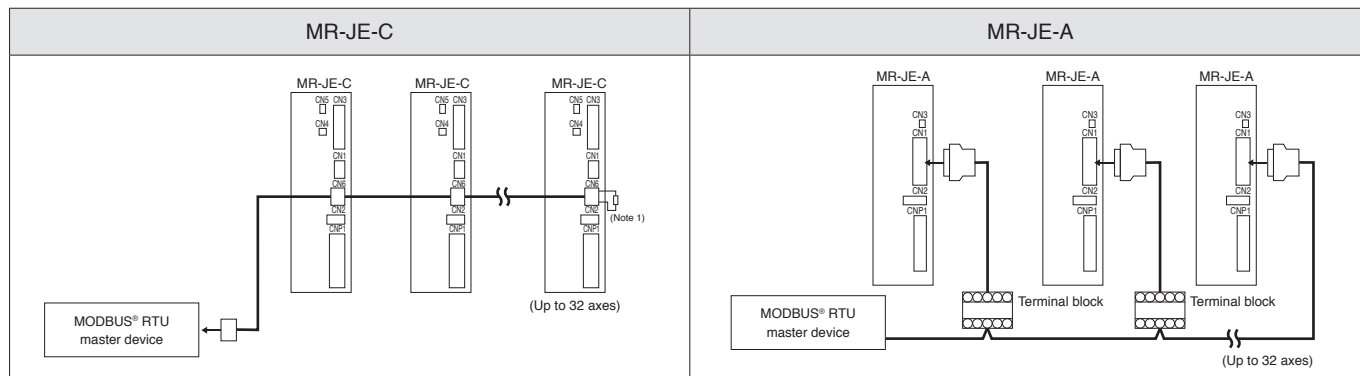

Notes: 1. For the final axis, terminate with 150 Ω resistor between DA and DB.

### MODBUS®/TCP, MODBUS® RTU Compatible Function Codes

C A

MR-JE-C and MR-JE-A servo amplifiers are compatible with the following function code.

Code	Function name	Description
03h	Read holding registers	Reading holding registers Reads data stored in holding registers from a master.
08h	Diagnostics	Functional diagnostics When this function code is sent from a master (client) to slaves (servers), the slaves (servers) return the data as it is. This function can be used for checking the communication status.
10h	Preset multiple registers	Writing to multiple registers Writes a series of data to multiple holding registers from a master (client).

### MODBUS®/TCP, MODBUS® RTU Functions (Note 1)

C A

The functions of MODBUS®/TCP and MODBUS® RTU are as follows. MODBUS®/TCP and MODBUS® RTU can operate and maintain the servo amplifier by remote control.

Function	Description
Status monitor	Reads the items of "Display All" in monitor function of MR Configurator2 such as servo motor speed and position deviation.
Parameter setting	Reads and writes parameters.
Point table setting	Reads and writes point table data.
Current alarm reading	Reads an alarm No. currently generated.
Alarm history reading	Reads all 16 alarm histories.
Parameter error No. reading/point table error No. reading	Reads corresponding parameter No. for parameter error and corresponding point table No. for point table error.
Input/output monitor	Reads on/off status of I/O signal and monitor situation of I/O device.
Motor driving	Drives servo motors.
Servo amplifier information reading	Reads servo amplifier model, software version, and cumulative power time.

Notes: 1. MODBUS®/TCP is supported by MR-JE-C with software version A3 or later.  
MODBUS® RTU is supported by MR-JE-C with software version A4 or later and MR-JE-A.

Servo Amplifiers

Servo Motors

Options/Peripheral Equipment

LVS/Wires

Product List

Cautions

## Simple Cam Specifications

A

Items			Specifications
Memory capacity	Storage area for cam data		8 Kbytes (non-volatile memory)
	Working area for cam data		8 Kbytes (RAM)
Number of registration			Maximum 8 (depending on cam resolution and coordinate number)
Comment			Maximum 32 single-byte characters for each cam data
Cam data	Stroke ratio data type	Cam resolution (Maximum number of registration)	256 (8), 512 (4), 1024 (2), 2048 (1)
		Stroke ratio	-100.000% to 100.000%
	Coordinate data type	Number of coordinates (Maximum number of registration)	2 to 1024 Example: 128 (8), 256 (4), 512 (2), 1024 (1)
		Coordinate data	Input value: 0 to 999999 Output value: -999999 to 999999
Cam curve			12 types (constant speed/constant acceleration/5th curve/single hypotenuse/cycloid/distorted trapezoid/distorted sine/distorted constant speed/trapezoid/reverse trapezoid/double hypotenuse/reverse double hypotenuse)



### 1-phase 200 V AC Class Power Supply Input Using a Neutral Point of 3-phase 400 V AC Class Power Supply

C B A

A 1-phase 200 V AC class power can be supplied with a use of a neutral point of a 3-phase 400 V AC class power supply. Use a step-down transformer as necessary to keep the power supply voltage between 200 V AC and 240 V AC.

 Do not input a 3-phase 400 V AC class power supply directly to the 200 V class servo amplifier. Doing so may cause the servo amplifier to malfunction.

● For 0.1 kW to 1 kW

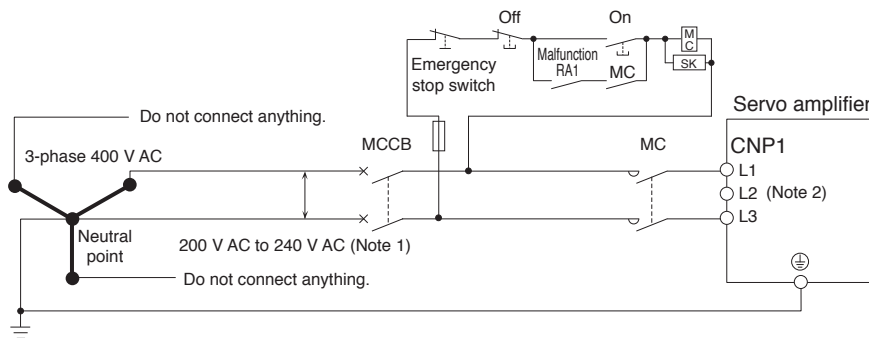

● For 2 kW

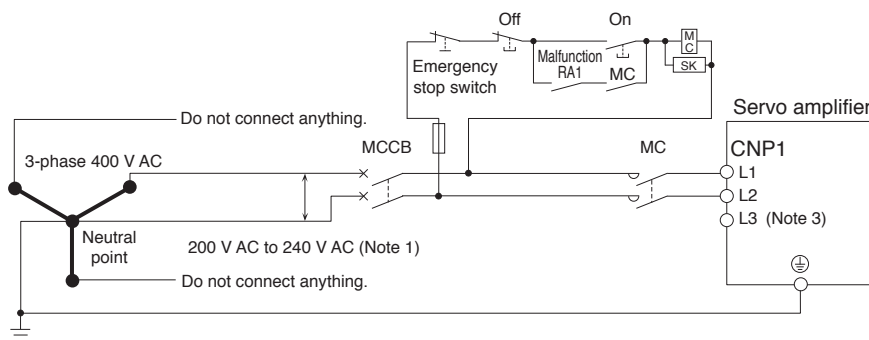

- Notes: 1. Use a step-down transformer as necessary to keep the power supply voltage between 200 V AC and 240 V AC.  
 2. For 1-phase 200 V AC to 240 V AC, connect the power supply to L1 and L3 terminals. Do not connect anything to L2.  
 3. For 1-phase 200 V AC to 240 V AC, connect the power supply to L1 and L2 terminals. Do not connect anything to L3.

 Be sure to read through Instruction Manual for the actual wiring and use. Use the equipment after you have a full knowledge of the equipment, safety information and instructions.

Servo Amplifiers  
 Servo Motors  
 Options/Peripheral Equipment  
 LVS/Wires  
 Product List  
 Cautions

MEMO



# 2

## Servo Motors

Model Designation.....	2-1
Combinations of Servo Motor and Servo Amplifier.....	2-1
Specifications	
HG-KN series .....	2-2
HG-SN series .....	2-4
Dimensions	
HG-KN series .....	2-7
HG-SN series .....	2-10
Sizing Example.....	2-11

# Servo Motors

## Model Designation

H G - K N 1 3 B J □

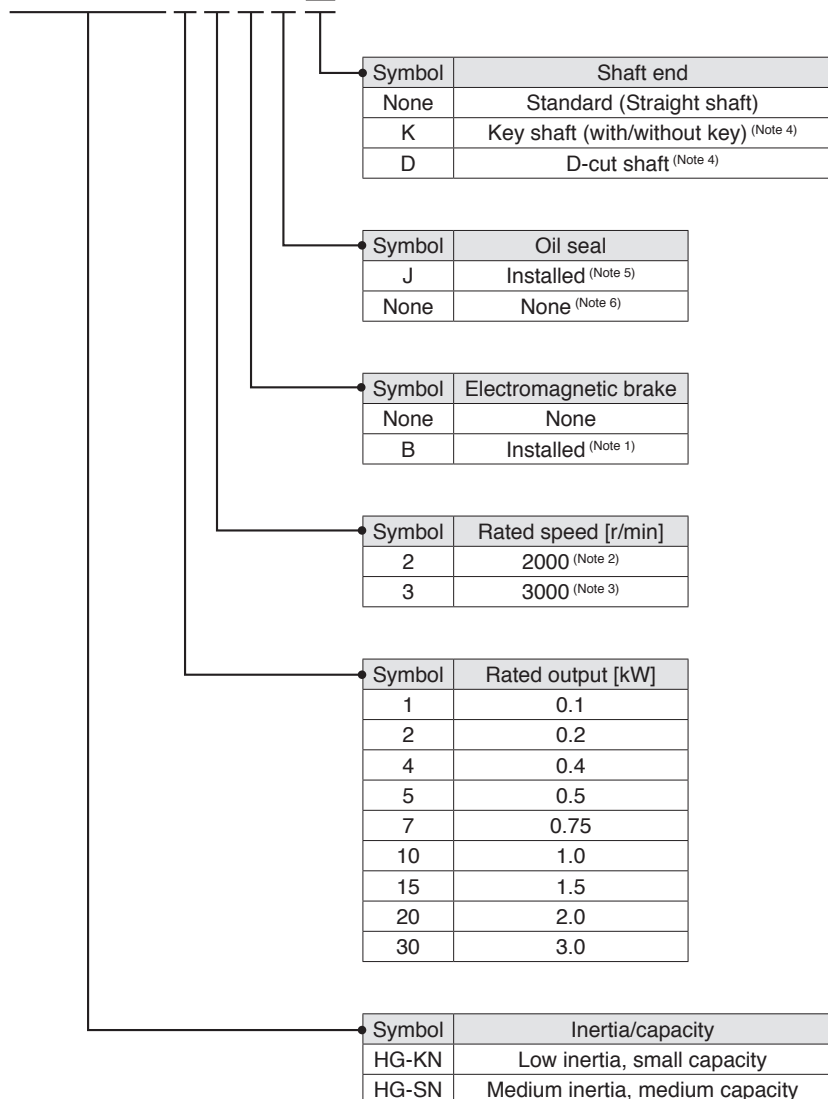

- Notes: 1. Refer to electromagnetic brake specifications of each servo motor series in this catalog for the detailed specifications.  
 2. 2000 r/min is for HG-SN series only.  
 3. 3000 r/min is for HG-KN series only.  
 4. Refer to special shaft end specifications of each servo motor series in this catalog for the available models and detailed specifications.  
 5. An oil seal is attached as a standard for all servo motors.  
 6. Available in HG-KN13 to HG-KN43.

## Combinations of Servo Motor and Servo Amplifier

	Servo motor	Servo amplifier
HG-KN series	HG-KN13(B)J	MR-JE-10C, MR-JE-10B, MR-JE-10A
	HG-KN23(B)J	MR-JE-20C, MR-JE-20B, MR-JE-20A
	HG-KN43(B)J	MR-JE-40C, MR-JE-40B, MR-JE-40A
	HG-KN73(B)J	MR-JE-70C, MR-JE-70B, MR-JE-70A
HG-SN series	HG-SN52(B)J	MR-JE-70C, MR-JE-70B, MR-JE-70A
	HG-SN102(B)J	MR-JE-100C, MR-JE-100B, MR-JE-100A
	HG-SN152(B)J	MR-JE-200C, MR-JE-200B, MR-JE-200A
	HG-SN202(B)J	MR-JE-200C, MR-JE-200B, MR-JE-200A
	HG-SN302(B)J	MR-JE-300C, MR-JE-300B, MR-JE-300A

**HG-KN Series (Low Inertia, Small Capacity) Specifications**

Servo motor model		HG-KN	13(B)J	23(B)J	43(B)J	73(B)J
Compatible servo amplifier model		Refer to "Combinations of Servo Motor and Servo Amplifier" on p. 2-1 in this catalog.				
Power supply capacity <sup>1</sup>		[kVA]	0.3	0.5	0.9	1.3
Continuous running duty	Rated output	[W]	100	200	400	750
	Rated torque <sup>(Note 3)</sup>	[N·m]	0.32	0.64	1.3	2.4
Maximum torque		[N·m]	0.95	1.9	3.8	7.2
Rated speed		[r/min]	3000			
Maximum speed		[r/min]	5000 (6000) <sup>(Note 6)</sup>			
Permissible instantaneous speed		[r/min]	5750 (6900) <sup>(Note 6)</sup>			
Power rate at continuous rated torque	Standard	[kW/s]	12.9	18.0	43.2	44.5
	With electromagnetic brake	[kW/s]	12.0	16.4	40.8	41.0
Rated current		[A]	0.8	1.3	2.6	4.8
Maximum current		[A]	2.4	3.9	7.8	14
Regenerative braking frequency <sup>2,3</sup>		[times/min]	(Note 4)	(Note 5)	276	159
Moment of inertia J	Standard	[× 10 <sup>-4</sup> kg·m <sup>2</sup> ]	0.0783	0.225	0.375	1.28
	With electromagnetic brake	[× 10 <sup>-4</sup> kg·m <sup>2</sup> ]	0.0843	0.247	0.397	1.39
Recommended load to motor inertia ratio <sup>(Note 1)</sup>			15 times or less			
Speed/position detector	Combination with MR-JE-C/ MR-JE-B		Absolute <sup>(Note 7)</sup> /incremental 17-bit encoder (resolution: 131072 pulses/rev)			
	Combination with MR-JE-A		Incremental 17-bit encoder (resolution: 131072 pulses/rev)			
Oil seal			Installed. Without oil seal is also available.			Installed
Thermistor			None			
Insulation class			130 (B)			
Structure			Totally enclosed, natural cooling (IP rating: IP65) <sup>(Note 2)</sup>			
Environment <sup>4</sup>	Ambient temperature		Operation: 0 °C to 40 °C (non-freezing), storage: -15 °C to 70 °C (non-freezing)			
	Ambient humidity		Operation: 10 %RH to 80 %RH (non-condensing), storage: 10 %RH to 90 %RH (non-condensing)			
	Ambience		Indoors (no direct sunlight); no corrosive gas, inflammable gas, oil mist or dust			
	Altitude		2000 m or less above sea level <sup>(Note 8)</sup>			
Vibration resistance <sup>5</sup>			X: 49 m/s <sup>2</sup> Y: 49 m/s <sup>2</sup>			
Vibration rank			V10 <sup>7</sup>			
Compliance with global standards			Refer to "Compliance with Global Standards and Regulations" on p. 25 in this catalog.			
Permissible load for the shaft <sup>6</sup>	L	[mm]	25	30	30	40
	Radial	[N]	88	245	245	392
	Thrust	[N]	59	98	98	147
Mass	Standard	[kg]	0.57	0.98	1.5	3.0
	With electromagnetic brake	[kg]	0.77	1.4	1.9	4.0

- Notes: 1. Contact your local sales office if the load to motor inertia ratio exceeds the value in the table.  
 2. The shaft-through portion is excluded. Refer to the asterisk 8 of "Annotations for Servo Motor Specifications" on p. 2-6 in this catalog for the shaft-through portion.  
 3. When unbalanced torque is generated, such as in a vertical lift machine, keep the unbalanced torque of the machine under 70% of the servo motor rated torque.  
 4. When the servo motor decelerates to a stop from the rated speed, the regenerative frequency will not be limited. When the servo motor decelerates to a stop from the maximum speed, the regenerative frequency will not be limited if the load to motor inertia ratio is 11 times or less.  
 5. When the servo motor decelerates to a stop from the rated speed, the regenerative frequency will not be limited if the load to motor inertia ratio is 9 times or less. When the servo motor decelerates to a stop from the maximum speed, the regenerative frequency will not be limited if the load to motor inertia ratio is 3 times or less.  
 6. The value in brackets is applicable with parameter setting. Refer to relevant Servo Amplifier Instruction Manual for details.  
 7. When absolute position detection system is used with MR-JE-C, absolute position data is read with the Ethernet communication. Refer to "MR-JE- C Servo Amplifier Instruction Manual" for details.  
 8. Refer to "HG-KN HG-SN Servo Motor Instruction Manual" for the restrictions when using the servo motors at altitude exceeding 1000 m and up to 2000 m above sea level.

Refer to "Annotations for Servo Motor Specifications" on p. 2-6 in this catalog for the asterisks 1 to 7.

Servo Amplifiers

Servo Motors

Options/Peripheral Equipment

LVS/Wires

Product List

Cautions

# Servo Motors

## HG-KN Series Electromagnetic Brake Specifications (Note 1)

Servo motor model	HG-KN	13BJ	23BJ	43BJ	73BJ
Type	Spring actuated type safety brake				
Rated voltage	24 V DC <sup>0</sup> <sub>-10%</sub>				
Power consumption [W] at 20 °C		6.3	7.9	7.9	10
Electromagnetic brake static friction torque [N·m]		0.32	1.3	1.3	2.4
Permissible braking work	Per braking [J]	5.6	22	22	64
	Per hour [J]	56	220	220	640
Electromagnetic brake life (Note 2)	Number of braking times	20000	20000	20000	20000
	Work per braking [J]	5.6	22	22	64

Notes: 1. The electromagnetic brake is for holding. It should not be used for deceleration applications.  
 2. Brake gap is not adjustable. Electromagnetic brake life is defined as the time period until the readjustment is needed.

## HG-KN Series Torque Characteristics

HG-KN13(B)J (Note 1, 2, 3)

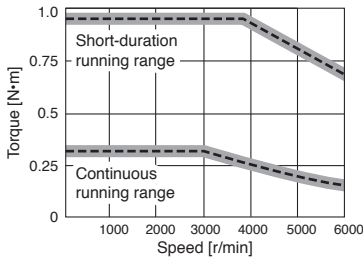

HG-KN23(B)J (Note 1, 2, 3)

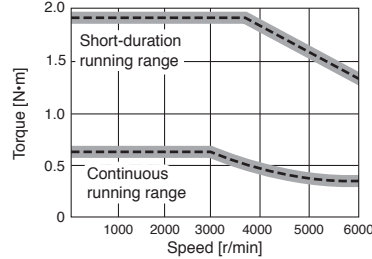

HG-KN43(B)J (Note 1, 2, 3)

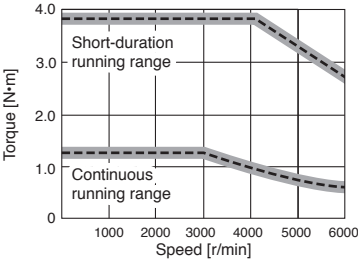

HG-KN73(B)J (Note 1, 2, 3)

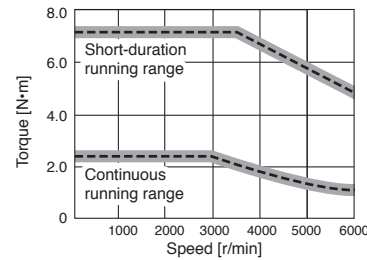

Notes: 1. ——— : For 3-phase 200 V AC.  
 2. - - - - : For 1-phase 230 V AC.  
 3. Torque drops when the power supply voltage is below the specified value.

## HG-KN Series Special Shaft End Specifications

Motors with the following specifications are also available.

D-cut shaft (Note 1): 100 W

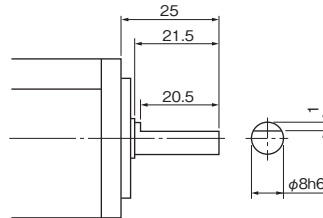

[Unit: mm]

Key shaft (with key) (Note 1, 2): 200 W, 400 W, and 750 W

Model	Variable dimensions								
	T	S	R	Q	W	QK	QL	U	Y
HG-KN23(B)JK, 43(B)JK	5	14h6	30	27	5	20	3	3	M4 screw Depth: 15
HG-KN73(B)JK	6	19h6	40	37	6	25	5	3.5	M5 screw Depth: 20

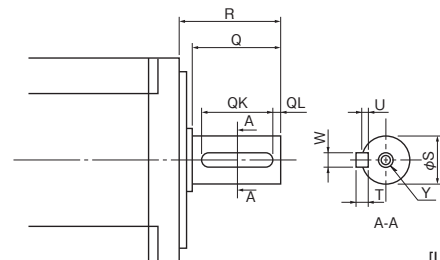

[Unit: mm]

Notes: 1. The servo motors with special shaft end are not suitable for frequent start/stop applications.  
 2. 2 round end key is attached.

**HG-SN Series (Medium Inertia, Medium Capacity) Specifications**

Servo motor model		HG-SN	52(B)J	102(B)J	152(B)J	202(B)J	302(B)J	
Compatible servo amplifier model		Refer to "Combinations of Servo Motor and Servo Amplifier" on p. 2-1 in this catalog.						
Power supply capacity <sup>1</sup>		[kVA]	1.0	1.7	2.5	3.5	4.8	
Continuous running duty	Rated output	[kW]	0.5	1.0	1.5	2.0	3.0	
	Rated torque <sup>(Note 3)</sup>	[N·m]	2.39	4.77	7.16	9.55	14.3	
Maximum torque		[N·m]	7.16	14.3	21.5	28.6	42.9	
Rated speed		[r/min]	2000					
Maximum speed		[r/min]	3000					2500
Permissible instantaneous speed		[r/min]	3450					2875
Power rate at continuous rated torque	Standard	[kW/s]	7.85	19.7	32.1	19.5	26.1	
	With electromagnetic brake	[kW/s]	6.01	16.5	28.2	16.1	23.3	
Rated current		[A]	2.9	5.6	9.4	9.6	11	
Maximum current		[A]	9.0	17	29	31	33	
Regenerative braking frequency <sup>2,3</sup>		[times/min]	62	38	139	47	28	
Moment of inertia J	Standard	[× 10 <sup>-4</sup> kg·m <sup>2</sup> ]	7.26	11.6	16.0	46.8	78.6	
	With electromagnetic brake	[× 10 <sup>-4</sup> kg·m <sup>2</sup> ]	9.48	13.8	18.2	56.5	88.2	
Recommended load to motor inertia ratio <sup>(Note 1)</sup>			15 times or less					
Speed/position detector	Combination with MR-JE-C/MR-JE-B		Absolute <sup>(Note 4)</sup> /incremental 17-bit encoder (resolution: 131072 pulses/rev)					
	Combination with MR-JE-A		Incremental 17-bit encoder (resolution: 131072 pulses/rev)					
Oil seal			Installed					
Thermistor			None					
Insulation class			155 (F)					
Structure			Totally enclosed, natural cooling (IP rating: IP67) <sup>(Note 2)</sup>					
Environment <sup>4</sup>	Ambient temperature		Operation: 0 °C to 40 °C (non-freezing), storage: -15 °C to 70 °C (non-freezing)					
	Ambient humidity		Operation: 10 %RH to 80 %RH (non-condensing), storage: 10 %RH to 90 %RH (non-condensing)					
	Ambience		Indoors (no direct sunlight); no corrosive gas, inflammable gas, oil mist or dust					
	Altitude		2000 m or less above sea level <sup>(Note 5)</sup>					
Vibration resistance <sup>5</sup>			X: 24.5 m/s <sup>2</sup> Y: 24.5 m/s <sup>2</sup>			X: 24.5 m/s <sup>2</sup> Y: 49 m/s <sup>2</sup>		
Vibration rank			V10 <sup>7</sup>					
Compliance with global standards			Refer to "Compliance with Global Standards and Regulations" on p. 25 in this catalog.					
Permissible load for the shaft <sup>6</sup>	L	[mm]	55	55	55	79	79	
	Radial	[N]	980	980	980	2058	2058	
	Thrust	[N]	490	490	490	980	980	
Mass	Standard	[kg]	4.8	6.2	7.3	11	16	
	With electromagnetic brake	[kg]	6.7	8.2	9.3	17	22	

- Notes: 1. Contact your local sales office if the load to motor inertia ratio exceeds the value in the table.  
 2. The shaft-through portion is excluded. Refer to the asterisk 8 of "Annotations for Servo Motor Specifications" on p. 2-6 in this catalog for the shaft-through portion.  
 3. When unbalanced torque is generated, such as in a vertical lift machine, keep the unbalanced torque of the machine under 70% of the servo motor rated torque.  
 4. When absolute position detection system is used with MR-JE-C, absolute position data is read with the Ethernet communication. Refer to "MR-JE\_C Servo Amplifier Instruction Manual" for details.  
 5. Refer to "HG-KN HG-SN Servo Motor Instruction Manual" for the restrictions when using the servo motors at altitude exceeding 1000 m and up to 2000 m above sea level.

Refer to "Annotations for Servo Motor Specifications" on p. 2-6 in this catalog for the asterisks 1 to 7.

Servo Amplifiers

Servo Motors

Options/Peripheral Equipment

LVS/Wires

Product List

Cautions

# Servo Motors

## HG-SN Series Electromagnetic Brake Specifications (Note 1)

Servo motor model	HG-SN	52BJ	102BJ	152BJ	202BJ	302BJ
Type	Spring actuated type safety brake					
Rated voltage	24 V DC $^{0}_{-10}\%$					
Power consumption [W] at 20 °C		20	20	20	34	34
Electromagnetic brake static friction torque [N·m]		8.5	8.5	8.5	44	44
Permissible braking work	Per braking [J]	400	400	400	4500	4500
	Per hour [J]	4000	4000	4000	45000	45000
Electromagnetic brake life (Note 2)	Number of braking times	20000	20000	20000	20000	20000
	Work per braking [J]	200	200	200	1000	1000

Notes: 1. The electromagnetic brake is for holding. It should not be used for deceleration applications.  
 2. Brake gap is not adjustable. Electromagnetic brake life is defined as the time period until the readjustment is needed.

## HG-SN Series Torque Characteristics

**HG-SN52(B)J** (Note 1, 2, 3)

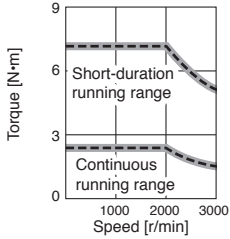

**HG-SN102(B)J** (Note 1, 2, 3)

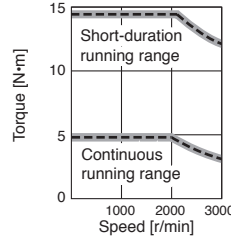

**HG-SN152(B)J** (Note 1, 2, 3)

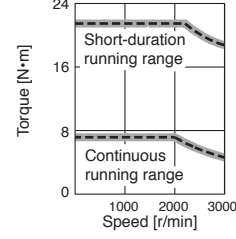

**HG-SN202(B)J** (Note 1, 2, 3)

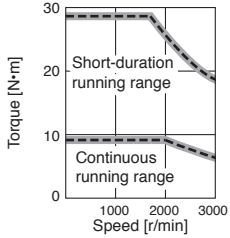

**HG-SN302(B)J** (Note 1, 2, 3)

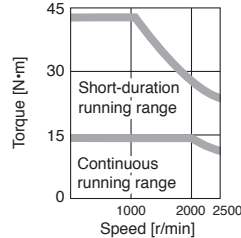

Notes: 1. ——— : For 3-phase 200 V AC.  
 2. - - - - : For 1-phase 230 V AC.  
 3. Torque drops when the power supply voltage is below the specified value.

## HG-SN Series Special Shaft End Specifications

Motors with the following specifications are also available.

Key shaft (without key) (Note 1, 2)

Model	Variable dimensions								
	S	R	Q	W	QK	QL	U	r	Y
HG-SN52(B)JK, 102(B)JK, 152(B)JK	24h6	55	50	8 <sup>0</sup> <sub>-0.036</sub>	36	5	4 <sup>+0.2</sup> <sub>0</sub>	4	M8 screw Depth: 20
HG-SN202(B)JK, 302(B)JK	35 <sup>+0.010</sup> <sub>0</sub>	79	75	10 <sup>0</sup> <sub>-0.036</sub>	55	5	5 <sup>+0.2</sup> <sub>0</sub>	5	

Notes: 1. The servo motors with special shaft end are not suitable for frequent start/stop applications.  
 2. A key is not supplied with the servo motor. The key shall be installed by the user.

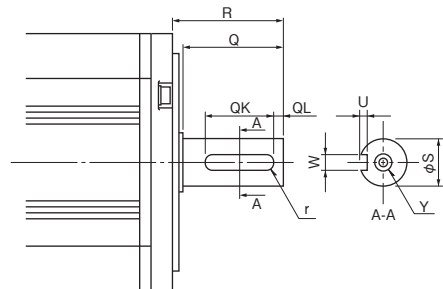

[Unit: mm]



## Annotations for Servo Motor Specifications

- \*1. The power supply capacity varies depending on the power supply impedance.
- \*2. The regenerative braking frequency shows the permissible frequency when the servo motor, without a load and a regenerative option, decelerates from the rated speed to a stop. When a load is connected; however, the value will be the table value/(m+1), where m = Moment of inertia of load/Moment of inertia of servo motor. When the operating speed exceeds the rated speed, the regenerative braking frequency is inversely proportional to the square of (operating speed/rated speed). Take measures to keep the regenerative power [W] during operation below the permissible regenerative power [W]. Use caution, especially when the operating speed changes frequently or when the regeneration is constant (as with vertical feeds). Select the most suitable regenerative option for your system with our capacity selection software. Refer to "Regenerative Option" in this catalog for the permissible regenerative power [W] when a regenerative option is used.
- \*3. For 400 W or smaller servo amplifiers, the regenerative braking frequency may change affected by the power supply voltage due to the large ratio of the energy charged into the electrolytic capacitor in the servo amplifier.
- \*4. In the environment where the servo motor is exposed to oil mist, oil and/or water, a standard specification servo motor may not be usable. Contact your local sales office for more details.
- \*5. The vibration direction is shown in the diagram below. The numerical value indicates the maximum value of the component (commonly the bracket in the opposite direction of the servo motor shaft). Fretting tends to occur on the bearing when the servo motor stops. Thus, maintain vibration level at approximately one-half of the allowable value.

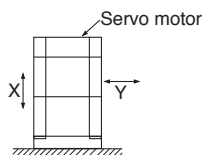

- \*6. Refer to the diagram below for the permissible load for the shaft. Do not apply a load exceeding the value specified in the table on the shaft. The values in the table are applicable when each load is applied singly.

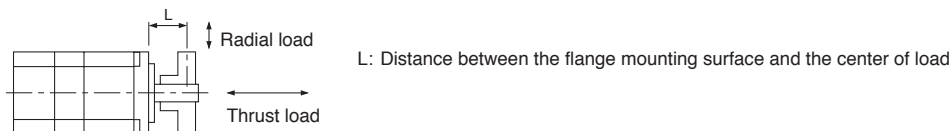

- \*7. V10 indicates that the amplitude of the servo motor itself is 10  $\mu\text{m}$  or less. The following shows mounting posture and measuring position of the servo motor during the measurement:

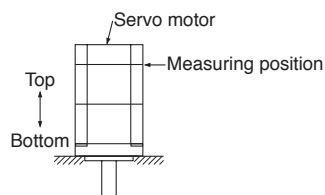

- \*8. Refer to the diagram below for shaft-through portion.

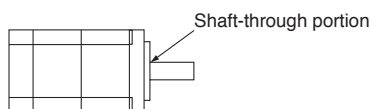

# Servo Motors

## HG-KN Series Dimensions (Note 1, 5)

### ●HG-KN13(B)J

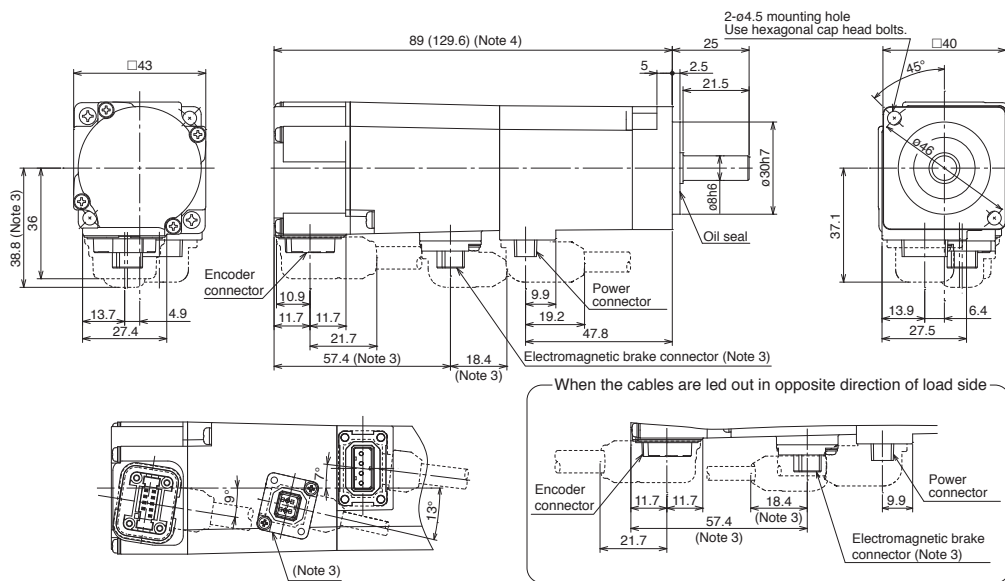

Power connector



Pin No.	Signal name
1	(PE)
2	U
3	V
4	W

Electromagnetic brake connector (Note 2)



Pin No.	Signal name
1	B1
2	B2

When the cables are led out in opposite direction of load side

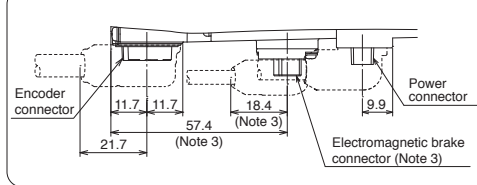

[Unit: mm]

### ●HG-KN13(B)

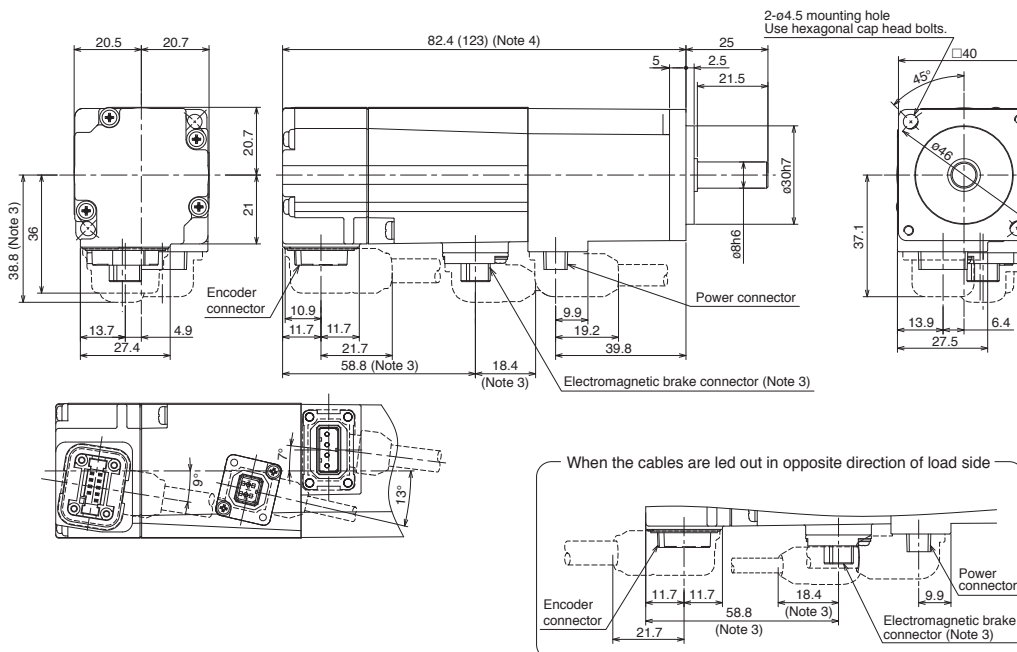

Power connector



Pin No.	Signal name
1	(PE)
2	U
3	V
4	W

Electromagnetic brake connector (Note 2)



Pin No.	Signal name
1	B1
2	B2

When the cables are led out in opposite direction of load side

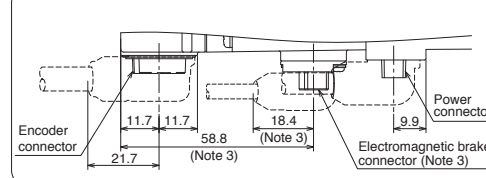

[Unit: mm]

- Notes: 1. For dimensions without tolerance, general tolerance applies.  
 2. The electromagnetic brake terminals (B1, B2) do not have polarity.  
 3. Only for the models with electromagnetic brake.  
 4. Dimensions in brackets are for the models with electromagnetic brake.  
 5. Use a friction coupling to fasten a load.



# Servo Motors

## HG-KN Series Dimensions (Note 1, 5)

### ●HG-KN73(B)J

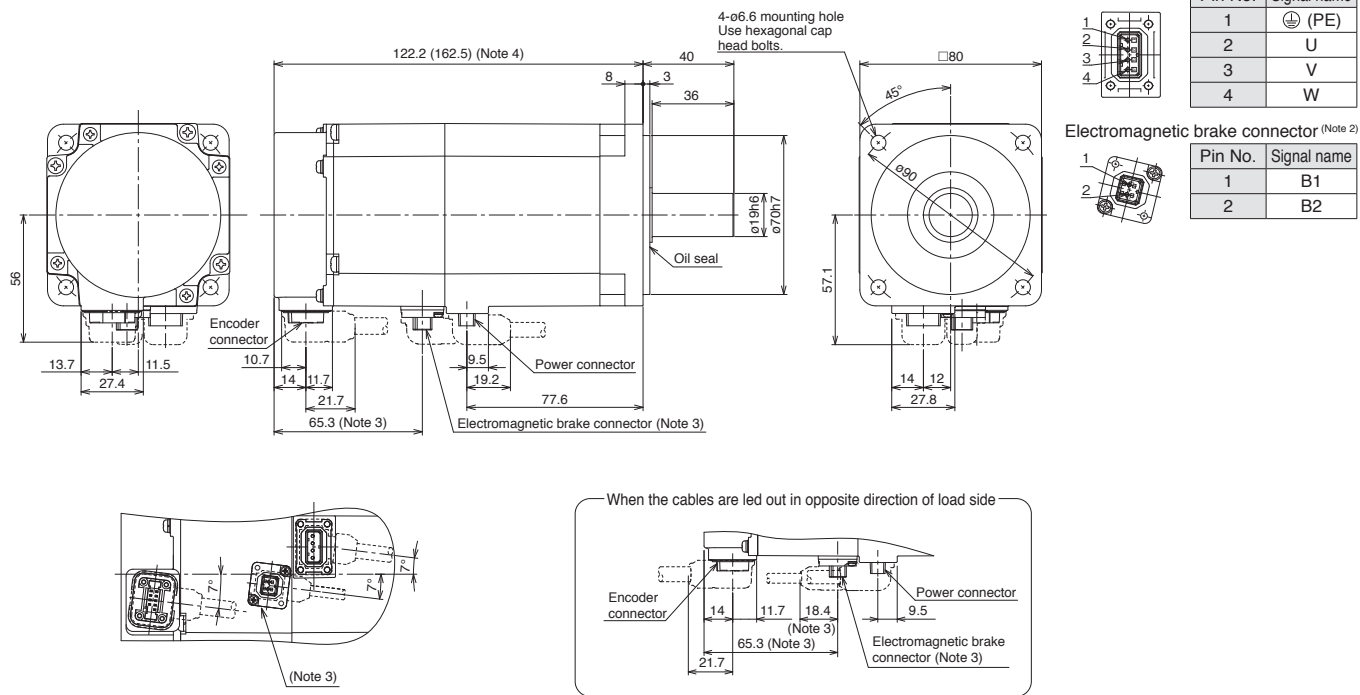

[Unit: mm]

- Notes: 1. For dimensions without tolerance, general tolerance applies.  
 2. The electromagnetic brake terminals (B1, B2) do not have polarity.  
 3. Only for the models with electromagnetic brake.  
 4. Dimensions in brackets are for the models with electromagnetic brake.  
 5. Use a friction coupling to fasten a load.

### HG-SN Series Dimensions (Note 1, 5)

#### ●HG-SN52(B)J, HG-SN102(B)J, HG-SN152(B)J

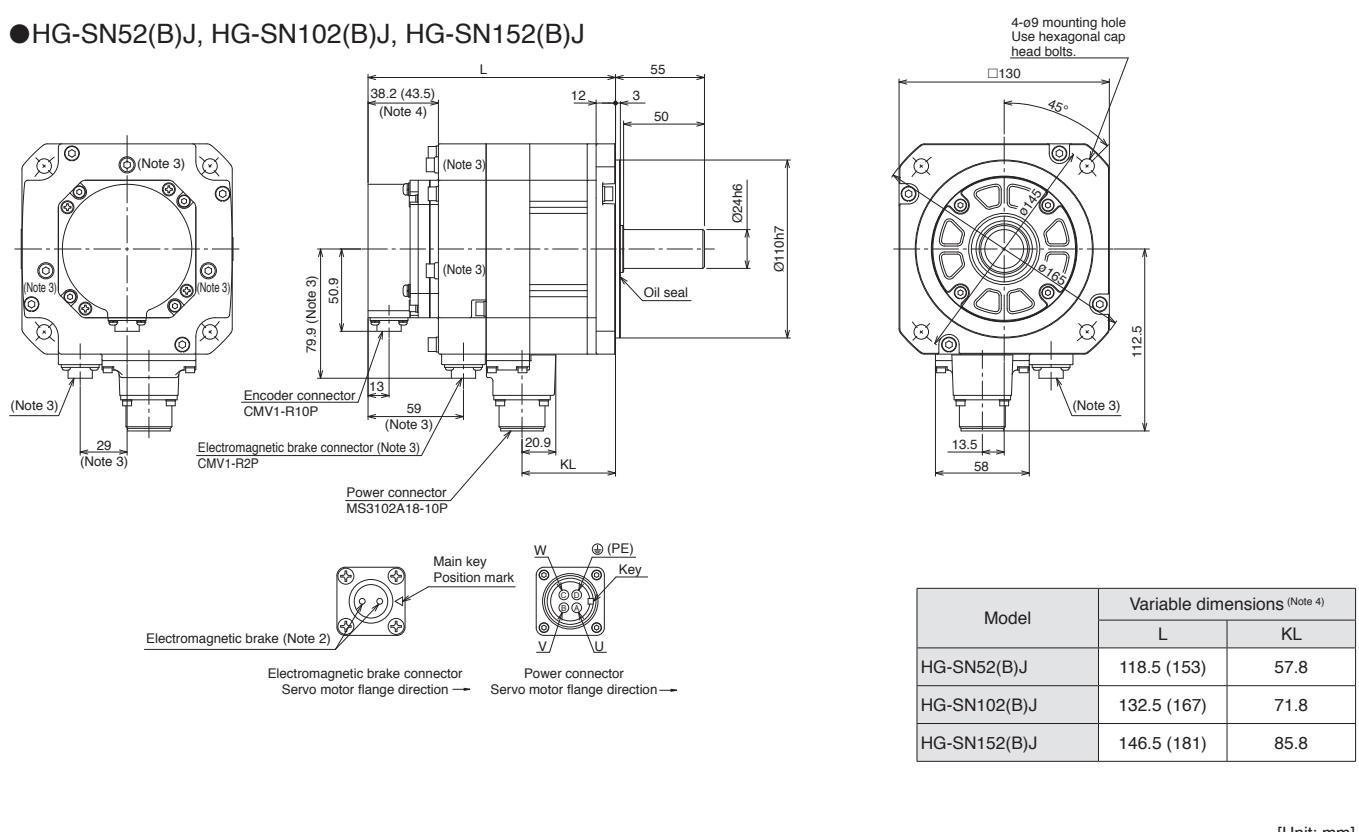

#### ●HG-SN202(B)J, HG-SN302(B)J

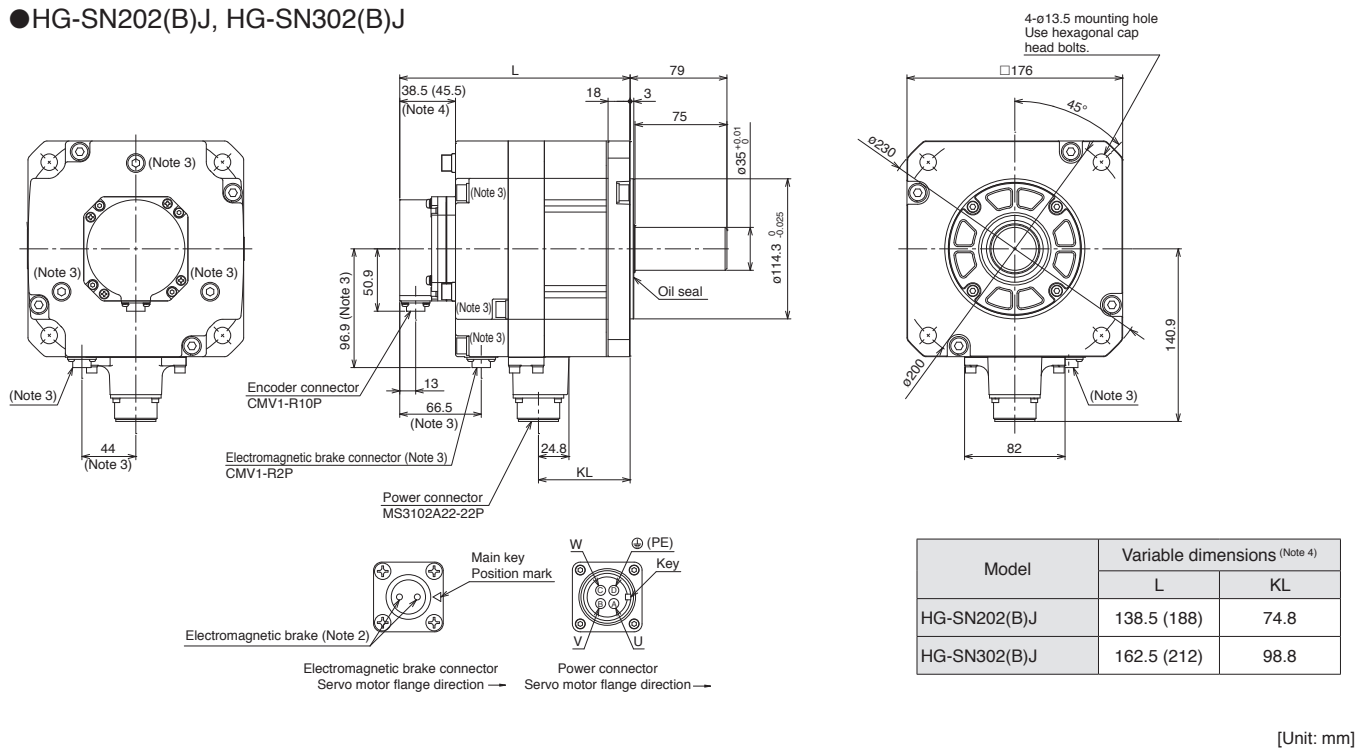

- Notes: 1. For dimensions without tolerance, general tolerance applies.  
 2. The electromagnetic brake terminals do not have polarity.  
 3. Only for the models with electromagnetic brake.  
 4. Dimensions in brackets are for the models with electromagnetic brake.  
 5. Use a friction coupling to fasten a load.

# Servo Motors

## Servo Motor Sizing Example

### 1. Selection criteria

#### (1) Configurations

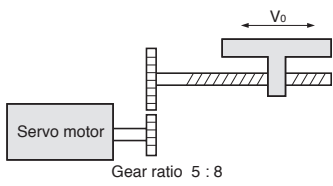

Feed speed of moving part  
 Feed length per cycle  
 Positioning time  
 Number of feed times  
 (Operating cycle)  
 Reduction ratio  
 Moving part mass  
 Drive system efficiency  
 Friction coefficient  
 Ball screw lead

$V_0 = 30000 \text{ mm/min}$   
 $\ell = 400 \text{ mm}$   
 $t_0 = \text{within } 1 \text{ s}$   
 40 times/min  
 $t_r = 1.5 \text{ s}$   
 $1/n = 5/8$   
 $W = 60 \text{ kg}$   
 $\eta = 0.8$   
 $\mu = 0.2$   
 $P_B = 16 \text{ mm}$

$D_B = \text{ball screw diameter} = 20 \text{ mm}$   
 $L_B = \text{ball screw length} = 500 \text{ mm}$   
 $D_{G1} = \text{gear diameter (servo motor shaft)} = 25 \text{ mm}$   
 $D_{G2} = \text{gear diameter (load shaft)} = 40 \text{ mm}$   
 $L_G = \text{gear tooth thickness} = 10 \text{ mm}$

#### (2) Servo motor speed

$$N_0 = \frac{V_0}{P_B} \times \frac{1}{1/n} = \frac{30000}{16} \times \frac{8}{5} = 3000 \text{ r/min}$$

#### (3) Acceleration/deceleration time constant

$$t_{psa} = t_{psd} = t_0 - \frac{\ell}{V_0/60} - t_s = 0.05 \text{ s}$$

$t_s$ : settling time. Here assumed 0.15 s.

#### (4) Operation pattern

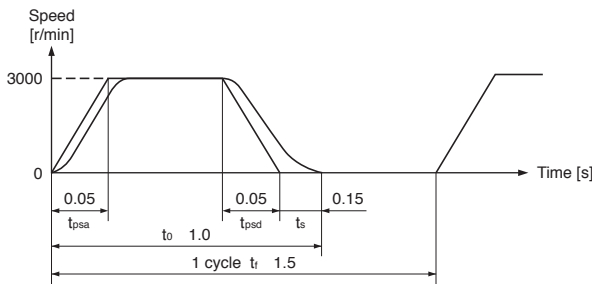

#### (3) Select a servo motor

##### Selection criteria

Load torque < Rated torque of servo motor

Moment of inertia of all loads <  $J_R$  × Moment of inertia of servo motor

$J_R$ : Recommended load to motor inertia ratio

Select the following servo motor to meet the criteria above.

HG-KN23J (rated torque: 0.64 N·m, max. torque: 1.9 N·m, moment of inertia:  $0.24 \times 10^{-4} \text{ kg}\cdot\text{m}^2$ )

#### (4) Acceleration/deceleration torque

Torque required during acceleration

$$T_{Ma} = \frac{(J_L / \eta + J_M) \times N_0}{9.55 \times 10^4 \times t_{psa}} + T_L = 1.84 \text{ N}\cdot\text{m}$$

$J_M$ : moment of inertia of servo motor

Torque required during deceleration

$$T_{Md} = -\frac{(J_L \times \eta + J_M) \times N_0}{9.55 \times 10^4 \times t_{psd}} + T_L = -0.85 \text{ N}\cdot\text{m}$$

Torque required during acceleration/deceleration must be equal to or lower than the max. torque of the servo motor.

## 2. Selecting servo motor

#### (1) Load torque (converted into the servo motor shaft)

Travel distance per servo motor revolution

$$\Delta S = P_B \times \frac{1}{n} = 10 \text{ mm}$$

$$T_L = \frac{\mu \times W \times g \times \Delta S}{2 \times 10^3 \pi \eta} = 0.23 \text{ N}\cdot\text{m}$$

#### (2) Moment of inertia of load (converted into the servo motor shaft)

Moving part

$$J_{L1} = W \times \left( \frac{\Delta S \times 10^{-3}}{2\pi} \right)^2 = 1.52 \times 10^{-4} \text{ kg}\cdot\text{m}^2$$

Ball screw

$$J_{L2} = \frac{\pi \times \rho \times L_B}{32} \times D_B^4 \times \left( \frac{1}{n} \right)^2 = 0.24 \times 10^{-4} \text{ kg}\cdot\text{m}^2$$

$\rho = 7.8 \times 10^3 \text{ kg/m}^3$  (iron)

Gear (servo motor shaft)

$$J_{L3} = \frac{\pi \times \rho \times L_G}{32} \times D_{G1}^4 = 0.03 \times 10^{-4} \text{ kg}\cdot\text{m}^2$$

Gear (load shaft)

$$J_{L4} = \frac{\pi \times \rho \times L_G}{32} \times D_{G2}^4 \times \left( \frac{1}{n} \right)^2 = 0.08 \times 10^{-4} \text{ kg}\cdot\text{m}^2$$

Moment of inertia of all loads (converted into the servo motor shaft)

$$J_L = J_{L1} + J_{L2} + J_{L3} + J_{L4} = 1.87 \times 10^{-4} \text{ kg}\cdot\text{m}^2$$

#### (5) Continuous effective load torque

$$T_{rms} = \sqrt{\frac{T_{Ma}^2 \times t_{psa} + T_L^2 \times t_c + T_{Md}^2 \times t_{psd}}{t_r}} = 0.40 \text{ N}\cdot\text{m}$$

$t_c = t_0 - t_s - t_{psa} - t_{psd}$

Continuous effective load torque must be equal to or lower than the rated torque of the servo motor.

#### (6) Torque pattern

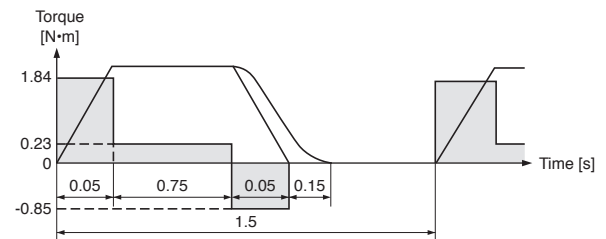

#### (7) Result

Select the following:

Servo motor: HG-KN23J

Servo amplifier: MR-JE-20B

[Free capacity selection software]

Capacity selection software (MRZJW3-MOTSZ111E) does all the calculations for you. The capacity selection software is available for free download. Contact your local sales office for more details.  
 \* Be sure to update your MRZJW3-MOTSZ111E to the latest version.

# 3

## Options/Peripheral Equipment

	Servo amplifier			●: Applicable
	C	B	A	
Basic Cable Configurations for Servo Motors	●	●	●	.....3-1
Configuration Example for Servo Motors	●	●	●	.....3-3
Details of Option Connectors for Servo Motors	●	●	●	.....3-9
Products on the Market for Servo Motors	●	●	●	.....3-12
Configuration Example for MR-JE-C	●			.....3-15
Configuration Example for MR-JE-B		●		.....3-17
Configuration Example for MR-JE-A			●	.....3-20
Details of Option Connectors for Servo Amplifiers	●	●	●	.....3-22
Products on the Market for Servo Amplifiers	●	●	●	.....3-24
Regenerative Option	●	●	●	.....3-25
Battery	●	●		.....3-27
Battery Case and Battery	●	●		.....3-27
Junction Terminal Block	●	●	●	.....3-28
Radio Noise Filter	●	●	●	.....3-29
Line Noise Filter	●	●	●	.....3-29
Data Line Filter	●	●	●	.....3-29
Surge Killer	●	●	●	.....3-29
EMC Filter	●	●	●	.....3-30
Power Factor Improving AC Reactor	●	●	●	.....3-31
Servo Support Software	●	●	●	.....3-32

# Options/Peripheral Equipment

## Basic Cable Configurations for Servo Motors

Necessary option cables and connectors vary depending on the servo motor series.  
Refer to the following tables for necessary options.

### Selecting options for servo motor

Use the cables in the following tables.

For the cable descriptions, refer to the relevant numbers in each list.

Capacity	Servo motor	Reference list		
		Encoder cable	Servo motor power cable	Electromagnetic brake cable <sup>(Note 1)</sup>
Small capacity	HG-KN	Column A in encoder cable list	Column A in servo motor power cable list	Column A in electromagnetic brake cable list
Medium capacity	HG-SN	Column B in encoder cable list	Column B in servo motor power cable list	Column B in electromagnetic brake cable list

Notes: 1. An electromagnetic brake cable is required only for servo motor with electromagnetic brake.

### Encoder cable list

	Cable length	IP rating <sup>(Note 1)</sup>	Cable lead out direction	Bending life	Model	Reference	Note
A	10 m or shorter (direct connection type)	IP65	In direction of load side	Long bending life	MR-J3ENCBL_M-A1-H	p. 3-5	
				Standard	MR-J3ENCBL_M-A1-L		
			In opposite direction of load side	Long bending life	MR-J3ENCBL_M-A2-H	p. 3-5	
				Standard	MR-J3ENCBL_M-A2-L		
	Exceeding 10 m (junction type)	IP20	In direction of load side	Long bending life	Two types of cables are required: MR-J3JCBL03M-A1-L, MR-EKCBL_M-H	p. 3-5	
				Standard	Two types of cables are required: MR-J3JCBL03M-A1-L, MR-EKCBL_M-L		
			In opposite direction of load side	Long bending life	Two types of cables are required: MR-J3JCBL03M-A2-L, MR-EKCBL_M-H	p. 3-5	
				Standard	Two types of cables are required: MR-J3JCBL03M-A2-L, MR-EKCBL_M-L		
		IP65	In direction of load side	Long bending life	Two types of cables are required: MR-J3JSCBL03M-A1-L, MR-J3ENSCBL_M-H	pp. 3-5 and 3-6	
				Standard	Two types of cables are required: MR-J3JSCBL03M-A1-L, MR-J3ENSCBL_M-L		
In opposite direction of load side			Long bending life	Two types of cables are required: MR-J3JSCBL03M-A2-L, MR-J3ENSCBL_M-H	pp. 3-5 and 3-6		
			Standard	Two types of cables are required: MR-J3JSCBL03M-A2-L, MR-J3ENSCBL_M-L			
B	2 m to 50 m	IP67	-	Long bending life	MR-J3ENSCBL_M-H	p. 3-6	
	2 m to 30 m			Standard	MR-J3ENSCBL_M-L		

Notes: 1. The IP rating indicated is for the connector's protection against ingress of dust and water when coupled to a servo amplifier/servo motor. If the IP rating of the servo amplifier/servo motor differs from that of these connectors, overall IP rating depends on the lowest of all.



## Servo motor power cable list

	Cable length	IP rating <sup>(Note 1)</sup>	Cable lead out direction	Bending life	Model	Reference	Note
A	10 m or shorter (direct connection type)	IP65	In direction of load side	Long bending life	MR-PWS1CBL_M-A1-H	p. 3-7	Select one from this list.
				Standard	MR-PWS1CBL_M-A1-L		
			In opposite direction of load side	Long bending life	MR-PWS1CBL_M-A2-H	p. 3-7	
				Standard	MR-PWS1CBL_M-A2-L		
Exceeding 10 m (junction type)	IP55	In direction of load side	Standard	Connect a user-fabricated cable to MR-PWS2CBL03M-A1-L (option cable).		p. 3-7	
		In opposite direction of load side		Connect a user-fabricated cable to MR-PWS2CBL03M-A2-L (option cable).		p. 3-7	

	IP rating <sup>(Note 1)</sup>	Compatible servo motor	Model	Reference	Note
B	IP67	HG-SN52J, 102J, 152J	Fabricate a cable that fits to MR-PWCNS4 (option connector set).	p. 3-7	Select one that is compatible with the servo motor.
		HG-SN202J, 302J	Fabricate a cable that fits to MR-PWCNS5 (option connector set).	p. 3-7	

## Electromagnetic brake cable list

	Cable length	IP rating <sup>(Note 1)</sup>	Cable lead out direction	Bending life	Model	Reference	Note
A	10 m or shorter (direct connection type)	IP65	In direction of load side	Long bending life	MR-BKS1CBL_M-A1-H	p. 3-8	Select one from this list.
				Standard	MR-BKS1CBL_M-A1-L		
			In opposite direction of load side	Long bending life	MR-BKS1CBL_M-A2-H	p. 3-8	
				Standard	MR-BKS1CBL_M-A2-L		
Exceeding 10 m (junction type)	IP55	In direction of load side	Standard	Connect a user-fabricated cable to MR-BKS2CBL03M-A1-L (option cable).		p. 3-8	
		In opposite direction of load side		Connect a user-fabricated cable to MR-BKS2CBL03M-A2-L (option cable).		p. 3-8	

	IP rating <sup>(Note 1)</sup>	Compatible servo motor	Model	Reference	Note
B	IP67	HG-SN series	Fabricate a cable that fits to MR-BKCNS1 or MR-BKCNS2 (option connector set) (straight type).	p. 3-8	Select one from this list.
			Fabricate a cable that fits to MR-BKCNS1A or MR-BKCNS2A (option connector set) (angle type).	p. 3-8	

Notes: 1. The IP rating indicated is for the connector's protection against ingress of dust and water when coupled to a servo amplifier/servo motor. If the IP rating of the servo amplifier/servo motor differs from that of these connectors, overall IP rating depends on the lowest of all.

## Configuration Example for Servo Motors

For HG-KN servo motor series: encoder cable length 10 m or shorter

- For leading the cables out in direction of load side (Note 1)

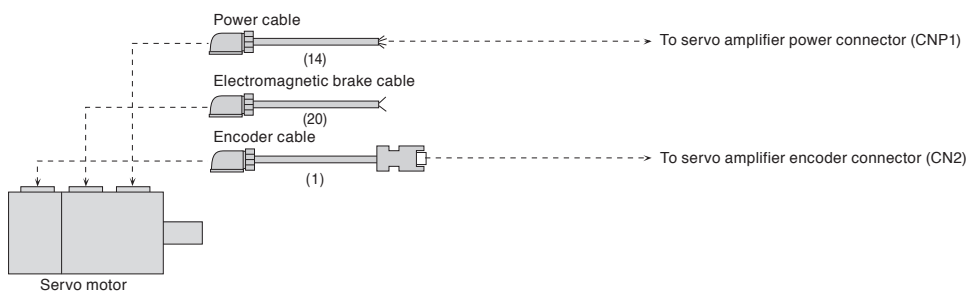

- For leading the cables out in opposite direction of load side (Note 1)

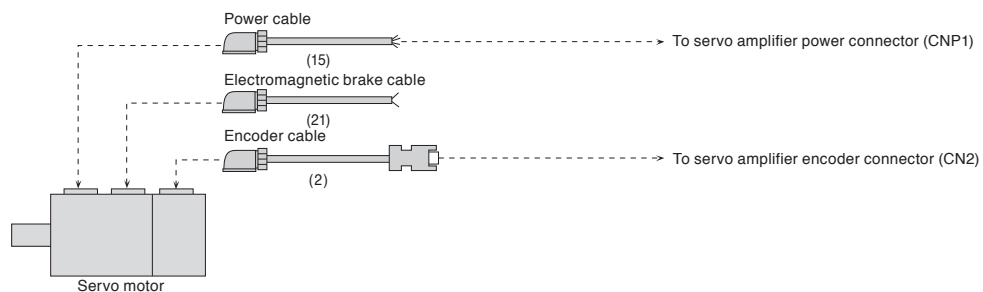

Notes: 1. Cables for leading two different directions may be used for one servo motor.

## Configuration Example for Servo Motors (Note 5)

C	B	A
---	---	---

For HG-KN servo motor series: encoder cable length over 10 m

● For leading the cables out in direction of load side (Note 4)

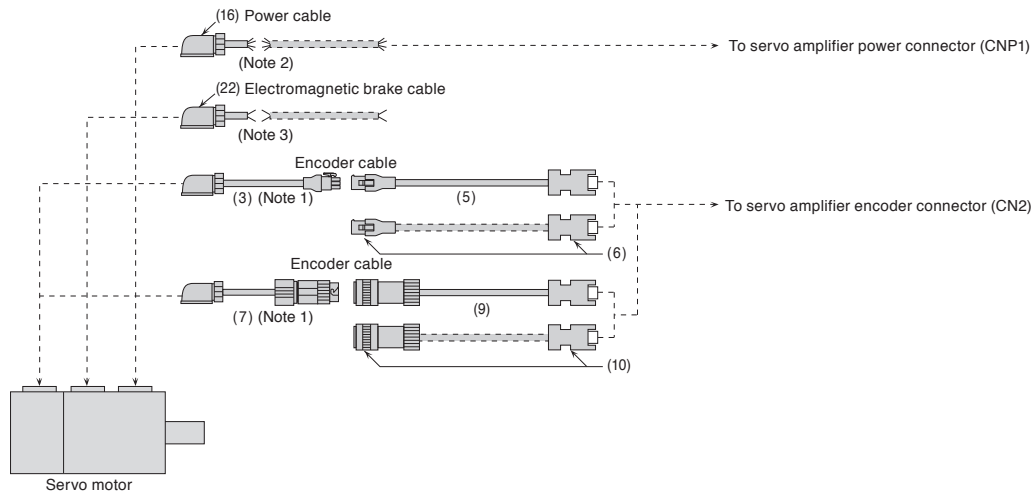

● For leading the cables out in opposite direction of load side (Note 4)

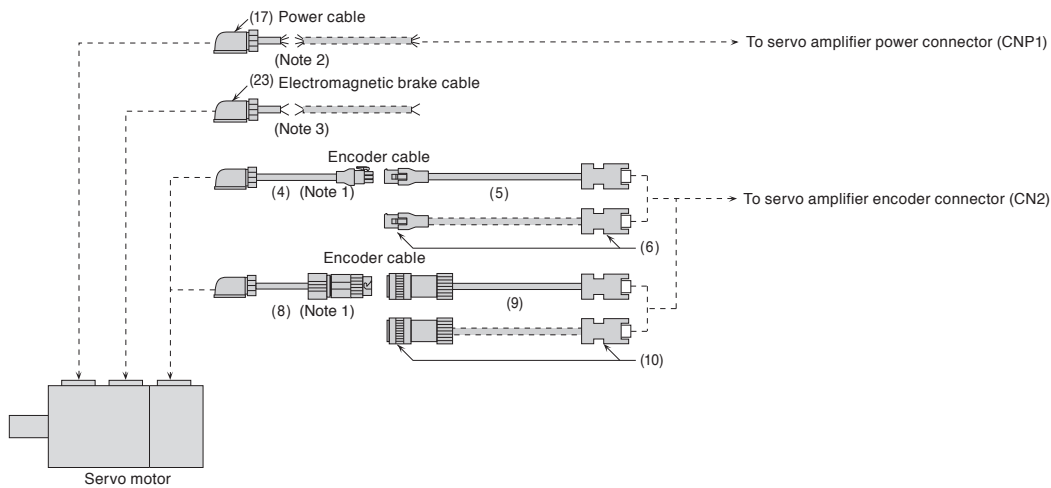

For HG-SN servo motor series

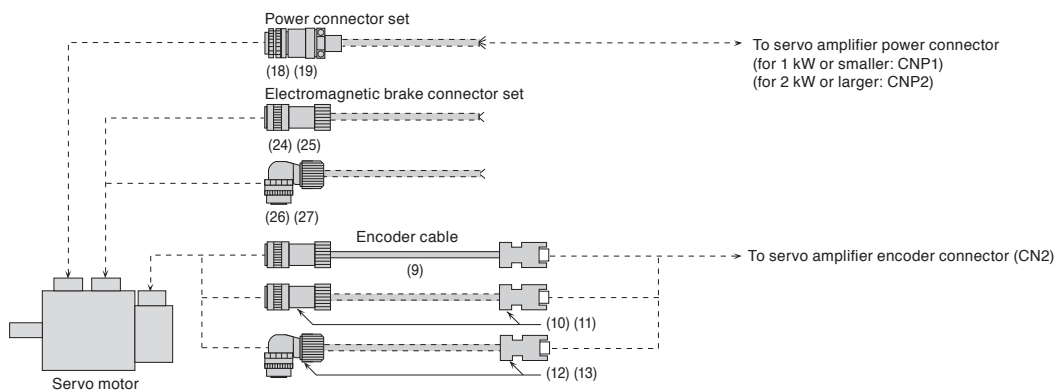







- Notes: 1. This cable does not have a long bending life. Thus, be sure to fix the cable before using.  
 2. Relay a cable using MR-PWS2CBL03M-A1-L or MR-PWS2CBL03M-A2-L. This cable does not have a long bending life. Thus, be sure to fix the cable before using.  
 3. Relay a cable using MR-BKS2CBL03M-A1-L or MR-BKS2CBL03M-A2-L. This cable does not have a long bending life. Thus, be sure to fix the cable before using.  
 4. Cables for leading two different directions may be used for one servo motor.  
 5. Cables drawn with dashed lines need to be fabricated by user. Refer to "HG-KN HG-SN Servo Motor Instruction Manual" for fabricating the cables.

# Options/Peripheral Equipment

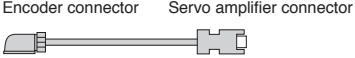
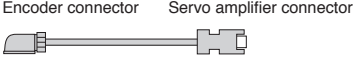
## Cables and Connectors for Servo Motor Encoder

Refer to "Details of Option Connectors for Servo Motors" in this catalog for the detailed models.

Encoder cables are not subject to European Low Voltage Directive (50 V AC to 1000 V AC and 75 V DC to 1500 V DC).

Item	Model	Cable length	IP rating (Note 1)	Application	Description
(1) Encoder cable (Note 2) (load-side lead)	MR-J3ENCBL2M-A1-H <sup>*1</sup>	2 m	IP65	For HG-KN (direct connection type)	Encoder connector    Servo amplifier connector 
	MR-J3ENCBL5M-A1-H <sup>*1</sup>	5 m			
	MR-J3ENCBL10M-A1-H <sup>*1</sup>	10 m			
	MR-J3ENCBL2M-A1-L <sup>*1</sup>	2 m			
	MR-J3ENCBL5M-A1-L <sup>*1</sup>	5 m			
	MR-J3ENCBL10M-A1-L <sup>*1</sup>	10 m			
(2) Encoder cable (Note 2) (opposite to load-side lead)	MR-J3ENCBL2M-A2-H <sup>*1</sup>	2 m	IP65	For HG-KN (direct connection type)	
	MR-J3ENCBL5M-A2-H <sup>*1</sup>	5 m			
	MR-J3ENCBL10M-A2-H <sup>*1</sup>	10 m			
	MR-J3ENCBL2M-A2-L <sup>*1</sup>	2 m			
	MR-J3ENCBL5M-A2-L <sup>*1</sup>	5 m			
	MR-J3ENCBL10M-A2-L <sup>*1</sup>	10 m			
(3) Encoder cable (Note 2) (load-side lead)	MR-J3JCBL03M-A1-L <sup>*1</sup>	0.3 m	IP20	For HG-KN (junction type)	Encoder connector    Junction connector 
(4) Encoder cable (Note 2) (opposite to load-side lead)	MR-J3JCBL03M-A2-L <sup>*1</sup>	0.3 m	IP20	For HG-KN (junction type)	Use this in combination with (5) or (6). 
(5) Encoder cable (Note 2)	MR-EKCBL20M-H <sup>*1</sup>	20 m	IP20	For HG-KN (junction type)	Junction connector    Servo amplifier connector  Use this in combination with (3) or (4).
	MR-EKCBL30M-H (Note 3) <sup>*1</sup>	30 m			
	MR-EKCBL40M-H (Note 3) <sup>*1</sup>	40 m			
	MR-EKCBL50M-H (Note 3) <sup>*1</sup>	50 m			
	MR-EKCBL20M-L <sup>*1</sup>	20 m			
	MR-EKCBL30M-L (Note 3) <sup>*1</sup>	30 m			
(6) Encoder connector set	MR-ECNM	-	IP20	For HG-KN (junction type)	Junction connector (Note 5)    Servo amplifier connector  Use this in combination with (3) or (4).  Applicable cable Wire size: 0.3 mm <sup>2</sup> (AWG 22) Cable OD: 8.2 mm
(7) Encoder cable (Note 2) (load-side lead)	MR-J3JSCBL03M-A1-L <sup>*1</sup>	0.3 m	IP65 (Note 4)	For HG-KN (junction type)	Encoder connector    Junction connector 
(8) Encoder cable (Note 2) (opposite to load-side lead)	MR-J3JSCBL03M-A2-L <sup>*1</sup>	0.3 m	IP65 (Note 4)	For HG-KN (junction type)	Use this in combination with (9) or (10). 

Notes: 1. The IP rating indicated is for the connector's protection against ingress of dust and water when coupled to a servo amplifier/servo motor. If the IP rating of the servo amplifier/servo motor differs from that of these connectors, overall IP rating depends on the lowest of all.

2. -H and -L indicate a bending life. -H indicates a long bending life, and -L indicates a standard bending life.

3. This encoder cable is available in four-wire type. Parameter setting is required to use the four-wire type encoder cable. Refer to relevant Servo Amplifier Instruction Manual for details.

4. The encoder cable is rated IP65 while the junction connector itself is rated IP67.

5. The crimping tool (91529-1) manufactured by TE Connectivity Ltd. Company is required.





For unlisted lengths

\*1. For unlisted lengths of the cables, please contact Mitsubishi Electric System & Service Co., Ltd. OVERSEAS SERVICE SECTION (Email: osb.webmaster@melsc.jp)

## Cables and Connectors for Servo Motor Encoder

Refer to "Details of Option Connectors for Servo Motors" in this catalog for the detailed models.

Encoder cables are not subject to European Low Voltage Directive (50 V AC to 1000 V AC and 75 V DC to 1500 V DC).

Item	Model	Cable length	IP rating (Note 1)	Application	Description
(9) Encoder cable (Note 2)	MR-J3ENSCBL2M-H <sup>*1</sup>	2 m	IP67	For HG-KN (junction type) For HG-SN (direct connection type)	Junction connector or encoder connector      Servo amplifier connector  Use this in combination with (7) or (8) for HG-KN series.
	MR-J3ENSCBL5M-H <sup>*1</sup>	5 m			
	MR-J3ENSCBL10M-H <sup>*1</sup>	10 m			
	MR-J3ENSCBL20M-H <sup>*1</sup>	20 m			
	MR-J3ENSCBL30M-H <sup>*1</sup>	30 m			
	MR-J3ENSCBL40M-H <sup>*1</sup>	40 m			
	MR-J3ENSCBL50M-H <sup>*1</sup>	50 m			
	MR-J3ENSCBL2M-L <sup>*1</sup>	2 m			
	MR-J3ENSCBL5M-L <sup>*1</sup>	5 m			
	MR-J3ENSCBL10M-L <sup>*1</sup>	10 m			
	MR-J3ENSCBL20M-L <sup>*1</sup>	20 m			
	MR-J3ENSCBL30M-L <sup>*1</sup>	30 m			
(10) Encoder connector set (Note 5) (one-touch connection type)	MR-J3SCNS	-	IP67	For HG-KN (junction type) For HG-SN (direct connection type) (straight type)	Junction connector or encoder connector      Servo amplifier connector  Use this in combination with (7) or (8) for HG-KN series.  Applicable cable Wire size: 0.5 mm <sup>2</sup> (AWG 20) or smaller Cable OD: 5.5 mm to 9.0 mm (Note 3)
(11) Encoder connector set (Note 4, 5) (screw type)	MR-ENCNS2 <sup>*2</sup>	-	IP67	For HG-SN (direct connection type) (straight type)	Encoder connector      Servo amplifier connector  Applicable cable Wire size: 0.5 mm <sup>2</sup> (AWG 20) or smaller Cable OD: 5.5 mm to 9.0 mm (Note 3)
(12) Encoder connector set (Note 5) (one-touch connection type)	MR-J3SCNSA <sup>*2</sup>	-	IP67	For HG-SN (angle type)	Encoder connector      Servo amplifier connector  Applicable cable Wire size: 0.5 mm <sup>2</sup> (AWG 20) or smaller Cable OD: 5.5 mm to 9.0 mm (Note 3)
(13) Encoder connector set (Note 4, 5) (screw type)	MR-ENCNS2A <sup>*2</sup>	-	IP67		Encoder connector      Servo amplifier connector  Applicable cable Wire size: 0.5 mm <sup>2</sup> (AWG 20) or smaller Cable OD: 5.5 mm to 9.0 mm (Note 3)

Notes: 1. The IP rating indicated is for the connector's protection against ingress of dust and water when coupled to a servo amplifier/servo motor. If the IP rating of the servo amplifier/servo motor differs from that of these connectors, overall IP rating depends on the lowest of all.

2. -H and -L indicate a bending life. -H indicates a long bending life, and -L indicates a standard bending life.

3. Cable clamps and bushings for cable OD of 5.5 mm to 7.5 mm and of 7.0 mm to 9.0 mm are included in the set.

4. A screw thread is cut on the encoder connector of HG-SN series, and the screw type connector can be used.

5. The connector contains a plug and contacts. Using contacts for other plugs may damage the connector. Be sure to use the enclosed contacts.

For unlisted lengths and fabricating cables





\*1. For unlisted lengths of the cables, please contact Mitsubishi Electric System & Service Co., Ltd. OVERSEAS SERVICE SECTION (Email: osb.webmaster@melsc.jp)

\*2. For fabricating encoder cables with these connectors, please contact Mitsubishi Electric System & Service Co., Ltd. OVERSEAS SERVICE SECTION (Email: osb.webmaster@melsc.jp)

# Options/Peripheral Equipment

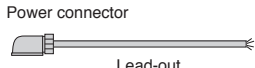
## Cables and Connectors for Servo Motor Power

Refer to "Details of Option Connectors for Servo Motors" in this catalog for the detailed models.

Item	Model	Cable length	IP rating (Note 1)	Application	Description
(14) Power cable (Note 2) (load-side lead)	MR-PWS1CBL2M-A1-H <sup>*1</sup>	2 m	IP65	For HG-KN (direct connection type)	 <p>Power connector Lead-out</p>
	MR-PWS1CBL5M-A1-H <sup>*1</sup>	5 m			
	MR-PWS1CBL10M-A1-H <sup>*1</sup>	10 m			
	MR-PWS1CBL2M-A1-L <sup>*1 (Note 3)</sup>	2 m			
	MR-PWS1CBL5M-A1-L <sup>*1 (Note 3)</sup>	5 m			
	MR-PWS1CBL10M-A1-L <sup>*1 (Note 3)</sup>	10 m			
(15) Power cable (Note 2) (opposite to load-side lead)	MR-PWS1CBL2M-A2-H <sup>*1</sup>	2 m	IP65	For HG-KN (direct connection type)	<p>* The cable is not shielded.</p>
	MR-PWS1CBL5M-A2-H <sup>*1</sup>	5 m			
	MR-PWS1CBL10M-A2-H <sup>*1</sup>	10 m			
	MR-PWS1CBL2M-A2-L <sup>*1 (Note 3)</sup>	2 m			
	MR-PWS1CBL5M-A2-L <sup>*1 (Note 3)</sup>	5 m			
	MR-PWS1CBL10M-A2-L <sup>*1 (Note 3)</sup>	10 m			
(16) Power cable (Note 2) (load-side lead)	MR-PWS2CBL03M-A1-L	0.3 m	IP55	For HG-KN (junction type)	 <p>Power connector Lead-out</p>
(17) Power cable (Note 2) (opposite to load-side lead)	MR-PWS2CBL03M-A2-L	0.3 m	IP55	For HG-KN (junction type)	<p>* The cable is not shielded.</p>
(18) Power connector set	MR-PWCNS4 <sup>*2</sup>	-	IP67	For HG-SN52J, 102J, 152J	 <p>Power connector</p> <p>Applicable cable Wire size: 2 mm<sup>2</sup> to 3.5 mm<sup>2</sup> (AWG 14 to 12) Cable OD: 10.5 mm to 14.1 mm</p>
(19) Power connector set	MR-PWCNS5 <sup>*2</sup>	-	IP67	For HG-SN202J, 302J	 <p>Power connector</p> <p>Applicable cable Wire size: 5.5 mm<sup>2</sup> to 8 mm<sup>2</sup> (AWG 10 to 8) Cable OD: 12.5 mm to 16 mm</p>





Notes: 1. The IP rating indicated is for the connector's protection against ingress of dust and water when coupled to a servo amplifier/servo motor. If the IP rating of the servo amplifier/servo motor differs from that of these connectors, overall IP rating depends on the lowest of all.  
 2. -H and -L indicate a bending life. -H indicates a long bending life, and -L indicates a standard bending life.  
 3. Shielded power cable MR-PWS3CBL\_M-A\_-L is also available. Contact your local sales office.

For unlisted lengths and fabricating cables

\*1. For unlisted lengths of the cables, please contact Mitsubishi Electric System & Service Co., Ltd. OVERSEAS SERVICE SECTION (Email: osb.webmaster@melsc.jp)  
 \*2. For fabricating power cables and electromagnetic brake cables, please contact Mitsubishi Electric System & Service Co., Ltd. OVERSEAS SERVICE SECTION (Email: osb.webmaster@melsc.jp)

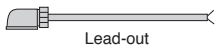
## Cables and Connectors for Servo Motor Electromagnetic Brake

Refer to "Details of Option Connectors for Servo Motors" in this catalog for the detailed models.

Item	Model	Cable length	IP rating (Note 1)	Application	Description
(20) Electromagnetic brake cable (Note 2) (load-side lead)	MR-BKS1CBL2M-A1-H <sup>*1</sup>	2 m	IP65	For HG-KN (direct connection type)	Electromagnetic brake connector  Lead-out
	MR-BKS1CBL5M-A1-H <sup>*1</sup>	5 m			
	MR-BKS1CBL10M-A1-H <sup>*1</sup>	10 m			
	MR-BKS1CBL2M-A1-L <sup>*1</sup>	2 m			
	MR-BKS1CBL5M-A1-L <sup>*1</sup>	5 m			
	MR-BKS1CBL10M-A1-L <sup>*1</sup>	10 m			
(21) Electromagnetic brake cable (Note 2) (opposite to load-side lead)	MR-BKS1CBL2M-A2-H <sup>*1</sup>	2 m	IP65	For HG-KN (direct connection type)	* The cable is not shielded.
	MR-BKS1CBL5M-A2-H <sup>*1</sup>	5 m			
	MR-BKS1CBL10M-A2-H <sup>*1</sup>	10 m			
	MR-BKS1CBL2M-A2-L <sup>*1</sup>	2 m			
	MR-BKS1CBL5M-A2-L <sup>*1</sup>	5 m			
	MR-BKS1CBL10M-A2-L <sup>*1</sup>	10 m			
(22) Electromagnetic brake cable (Note 2) (load-side lead)	MR-BKS2CBL03M-A1-L	0.3 m	IP55	For HG-KN (junction type)	Electromagnetic brake connector  Lead-out * The cable is not shielded.
(23) Electromagnetic brake cable (Note 2) (opposite to load-side lead)	MR-BKS2CBL03M-A2-L	0.3 m	IP55	For HG-KN (junction type)	* The cable is not shielded.
(24) Electromagnetic brake connector set (Note 4) (one-touch connection type)	MR-BKCNS1 <sup>*2</sup>	-	IP67	For HG-SN (straight type)	Electromagnetic brake connector 
(25) Electromagnetic brake connector set (Note 3, 4) (screw type)	MR-BKCNS2 <sup>*2</sup>	-	IP67		Applicable cable Wire size: 1.25 mm <sup>2</sup> (AWG 16) or smaller Cable OD: 9.0 mm to 11.6 mm
(26) Electromagnetic brake connector set (Note 4) (one-touch connection type)	MR-BKCNS1A <sup>*2</sup>	-	IP67	For HG-SN (angle type)	Electromagnetic brake connector 
(27) Electromagnetic brake connector set (Note 3, 4) (screw type)	MR-BKCNS2A <sup>*2</sup>	-	IP67		Applicable cable Wire size: 1.25 mm <sup>2</sup> (AWG 16) or smaller Cable OD: 9.0 mm to 11.6 mm

Notes: 1. The IP rating indicated is for the connector's protection against ingress of dust and water when coupled to a servo amplifier/servo motor. If the IP rating of the servo amplifier/servo motor differs from that of these connectors, overall IP rating depends on the lowest of all.

2. -H and -L indicate a bending life. -H indicates a long bending life, and -L indicates a standard bending life.

3. A screw thread is cut on the encoder connector of HG-SN series, and the screw type connector can be used.



4. The connector contains a plug and contacts. Using contacts for other plugs may damage the connector. Be sure to use the enclosed contacts.



For unlisted lengths and fabricating cables



\*1. For unlisted lengths of the cables, please contact Mitsubishi Electric System & Service Co., Ltd. OVERSEAS SERVICE SECTION (Email: osb.webmaster@melsc.jp)  
\*2. For fabricating power cables and electromagnetic brake cables, please contact Mitsubishi Electric System & Service Co., Ltd. OVERSEAS SERVICE SECTION (Email: osb.webmaster@melsc.jp)



# Options/Peripheral Equipment



## Details of Option Connectors for Servo Motors



Model	Encoder connector	Servo amplifier connector
MR-J3ENCBL_M-A1-H (Note 2) MR-J3ENCBL_M-A1-L (Note 2) MR-J3ENCBL_M-A2-H (Note 2) MR-J3ENCBL_M-A2-L (Note 2)	 2174053-1 (TE Connectivity Ltd. Company)	 Receptacle: 36210-0100PL Shell kit: 36310-3200-008 (3M) or Connector set: 54599-1019 (Molex)

Model	Encoder connector	Junction connector
MR-J3JCBLO3M-A1-L (Note 2) MR-J3JCBLO3M-A2-L (Note 2)	 2174053-1 (TE Connectivity Ltd. Company)	 Contact: 1473226-1 (with ring) Housing: 1-172169-9 Cable clamp: 316454-1 (TE Connectivity Ltd. Company)

Model	Junction connector	Servo amplifier connector
MR-EKCBL_M-H MR-EKCBL_M-L MR-ECNM	 Housing: 1-172161-9 Connector pin: 170359-1 (TE Connectivity Ltd. Company) or an equivalent product Cable clamp: MTI-0002 (Toa Electric Industrial Co., Ltd.)	 Receptacle: 36210-0100PL Shell kit: 36310-3200-008 (3M) or Connector set: 54599-1019 (Molex)

Model	Encoder connector	Junction connector
MR-J3JSCBLO3M-A1-L (Note 2) MR-J3JSCBLO3M-A2-L (Note 2)	 2174053-1 (TE Connectivity Ltd. Company)	 Cable receptacle: CM10-CR10P-M (DDK Ltd.)

Model	Encoder connector	Servo amplifier connector
MR-J3ENSABL_M-H (Note 2) MR-J3ENSABL_M-L (Note 2)	 For 10 m or shorter cable Straight plug: CMV1-SP10S-M1 Socket contact: CMV1-#22ASC-C1-100 For 20 m or longer cable Straight plug: CMV1-SP10S-M1 (long bending life) CMV1-SP10S-M2 (standard) Socket contact: CMV1-#22ASC-C2-100 (DDK Ltd.)	 Receptacle: 36210-0100PL Shell kit: 36310-3200-008 (3M) or Connector set: 54599-1019 (Molex)

Model	Junction connector/encoder connector	Servo amplifier connector
MR-J3SCNS (Note 2, 3)	 Straight plug: CMV1-SP10S-M2 (Note 1) Socket contact: CMV1-#22ASC-S1-100 (DDK Ltd.)	 Receptacle: 36210-0100PL Shell kit: 36310-3200-008 (3M) or Connector set: 54599-1019 (Molex)



Notes: 1. Cable clamps and bushings for cable OD of 5.5 mm to 7.5 mm and of 7.0 mm to 9.0 mm are included in the set.



2. The cable or the connector set may contain different connectors but still usable.

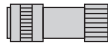

3. The connector contains a plug and contacts. Using contacts for other plugs may damage the connector. Be sure to use the enclosed contacts.





## Details of Option Connectors for Servo Motors

Model	Encoder connector	Servo amplifier connector
MR-ENCNS2 (Note 3)	 Straight plug: CMV1S-SP10S-M2 (Note 1) Socket contact: CMV1-#22ASC-S1-100 (DDK Ltd.)	 Receptacle: 36210-0100PL Shell kit: 36310-3200-008 (3M) or Connector set: 54599-1019 (Molex)

Model	Encoder connector	Servo amplifier connector
MR-J3SCNSA (Note 2, 3)	 Angle plug: CMV1-AP10S-M2 (Note 1) Socket contact: CMV1-#22ASC-S1-100 (DDK Ltd.)	 Receptacle: 36210-0100PL Shell kit: 36310-3200-008 (3M) or Connector set: 54599-1019 (Molex)

Model	Encoder connector	Servo amplifier connector
MR-ENCNS2A (Note 3)	 Angle plug: CMV1S-AP10S-M2 (Note 1) Socket contact: CMV1-#22ASC-S1-100 (DDK Ltd.)	 Receptacle: 36210-0100PL Shell kit: 36310-3200-008 (3M) or Connector set: 54599-1019 (Molex)

Model	Power connector
MR-PWS1CBL_M-A1-H (Note 2) MR-PWS1CBL_M-A1-L (Note 2) MR-PWS1CBL_M-A2-H (Note 2) MR-PWS1CBL_M-A2-L (Note 2)	 Plug: KN4FT04SJ1-R Socket contact: ST-TMH-S-C1B-100-(A534G) (Japan Aviation Electronics Industry, Limited)

Model	Power connector
MR-PWS2CBL03M-A1-L (Note 2) MR-PWS2CBL03M-A2-L (Note 2)	 Plug: KN4FT04SJ2-R Socket contact: ST-TMH-S-C1B-100-(A534G) (Japan Aviation Electronics Industry, Limited)

Model	Power connector
MR-PWCNS4	 Plug: CE05-6A18-10SD-D-BSS (straight) Cable clamp: CE3057-10A-1-D (DDK Ltd.)

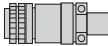
Model	Power connector
MR-PWCNS5	 Plug: CE05-6A22-22SD-D-BSS (straight) Cable clamp: CE3057-12A-1-D (DDK Ltd.)





Notes: 1. Cable clamps and bushings for cable OD of 5.5 mm to 7.5 mm and of 7.0 mm to 9.0 mm are included in the set.

2. The cable or the connector set may contain different connectors but still usable.

3. The connector contains a plug and contacts. Using contacts for other plugs may damage the connector. Be sure to use the enclosed contacts.

## Options/Peripheral Equipment

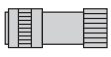
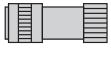
### Details of Option Connectors for Servo Motors

Model	Electromagnetic brake connector	
MR-BKS1CBL_M-A1-H MR-BKS1CBL_M-A1-L MR-BKS1CBL_M-A2-H MR-BKS1CBL_M-A2-L		Plug: JN4FT02SJ1-R Socket contact: ST-TMH-S-C1B-100-(A534G) (Japan Aviation Electronics Industry, Limited)
MR-BKS2CBL03M-A1-L MR-BKS2CBL03M-A2-L		Plug: JN4FT02SJ2-R Socket contact: ST-TMH-S-C1B-100-(A534G) (Japan Aviation Electronics Industry, Limited)
MR-BKCNS1 (Note 1, 2)		Straight plug: CMV1-SP2S-L Socket contact: CMV1-#22BSC-S2-100 (DDK Ltd.)
MR-BKCNS2 (Note 2)		Straight plug: CMV1S-SP2S-L Socket contact: CMV1-#22BSC-S2-100 (DDK Ltd.)
MR-BKCNS1A (Note 1, 2)		Angle plug: CMV1-AP2S-L Socket contact: CMV1-#22BSC-S2-100 (DDK Ltd.)
MR-BKCNS2A (Note 2)		Angle plug: CMV1S-AP2S-L Socket contact: CMV1-#22BSC-S2-100 (DDK Ltd.)

Notes: 1. The cable or the connector set may contain different connectors but still usable.

2. The connector contains a plug and contacts. Using contacts for other plugs may damage the connector. Be sure to use the enclosed contacts.

## Products on the Market for Servo Motors

Contact the relevant manufacturers directly.

When fabricating a cable with the following connectors, refer to the relevant manufacturers' instruction manuals for wiring and assembling procedures.

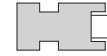

### Encoder connector (servo amplifier-side)

Application	Connector (3M)
Servo amplifier CN2 connector	Receptacle: 36210-0100PL Shell kit: 36310-3200-008
	Connector (Molex)
	54599-1019 (gray) 54599-1016 (black)

### Encoder connector for HG-KN series



Applicable servo motor	Feature <sup>(Note 1)</sup>	Connector (TE Connectivity Ltd. Company)	Crimping tool (TE Connectivity Ltd. Company)	Applicable cable example
HG-KN	IP65	2174053-1	For ground clip: 1596970-1 For receptacle contact: 1596847-1	Wire size: 0.13 mm <sup>2</sup> to 0.33 mm <sup>2</sup> (AWG 26 to 22) Cable OD: 6.8 mm to 7.4 mm Wire example: Fluorine resin wire (Vinyl jacket cable TPE. SVP 70/0.08(AWG#22)-3P KB-2237-2 Bando Densen Co., Ltd. <sup>(Note 2)</sup> or an equivalent product)

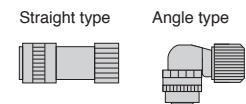

### Encoder connector for HG-SN series

Applicable servo motor	Feature <sup>(Note 1)</sup>	Connector (DDK Ltd.)				Applicable cable example Cable OD [mm]
		Type	Type of connection	Plug	Socket contact	
HG-SN	IP67	Straight	One-touch connection type	CMV1-SP10S-M1	Select from solder or press bonding type. (Refer to the table below.)	5.5 to 7.5
				CMV1-SP10S-M2		7.0 to 9.0
			Screw type	CMV1S-SP10S-M1		5.5 to 7.5
				CMV1S-SP10S-M2		7.0 to 9.0
		Angle	One-touch connection type	CMV1-AP10S-M1		5.5 to 7.5
				CMV1-AP10S-M2		7.0 to 9.0
			Screw type	CMV1S-AP10S-M1		5.5 to 7.5
				CMV1S-AP10S-M2		7.0 to 9.0

Contact	Socket contact (DDK Ltd.)	Wire size <sup>(Note 3)</sup>
Solder type	CMV1-#22ASC-S1-100	0.5 mm <sup>2</sup> (AWG 20) or smaller
Press bonding type	CMV1-#22ASC-C1-100	0.2 mm <sup>2</sup> to 0.5 mm <sup>2</sup> (AWG 24 to 20) Crimping tool (357J-53162T) is required.
	CMV1-#22ASC-C2-100	0.08 mm <sup>2</sup> to 0.2 mm <sup>2</sup> (AWG 28 to 24) Crimping tool (357J-53163T) is required.

Notes: 1. The IP rating indicated is for the connector's protection against ingress of dust and water when coupled to a servo amplifier/servo motor. If the IP rating of the servo amplifier/servo motor differs from that of these connectors, overall IP rating depends on the lowest of all.

2. Contact Toa Electric Industrial Co., Ltd.

3. The wire size shows wiring specification of the connector.

# Options/Peripheral Equipment

## Products on the Market for Servo Motors

Contact the relevant manufacturers directly.

When fabricating a cable with the following connectors, refer to the relevant manufacturers' instruction manuals for wiring and assembling procedures.

### Power connector for HG-KN series



Applicable servo motor	Feature (Note 1)	Connector (Japan Aviation Electronics Industry, Limited)	Crimping tool (Japan Aviation Electronics Industry, Limited)	Applicable cable example
HG-KN	IP65	Plug: KN4FT04SJ1-R Socket contact: ST-TMH-S-C1B-100-(A534G)	For contactor: CT170-14-TMH5B	Wire size: 0.3 mm <sup>2</sup> to 0.75 mm <sup>2</sup> (AWG 22 to 18) Cable OD: 5.3 mm to 6.5 mm Wire example: Fluorine resin wire (Vinyl jacket cable RMFES-A (CL3X) AWG 19, 4 cores Dyden Corporation (Note 4) or an equivalent product)

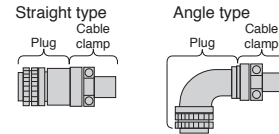

### Power connector for HG-SN series

Applicable servo motor	Feature (Note 1)	Plug (with backshell) (DDK Ltd.)		Cable clamp (DDK Ltd.)	Applicable cable example	
		Type	Model	Model	Wire size (Note 3)	Cable OD [mm]
HG-SN52J, 102J, 152J	IP67 EN compliant	Straight	CE05-6A18-10SD-D-BSS	CE3057-10A-2-D	2.2 mm <sup>2</sup> to 3.5 mm <sup>2</sup> (AWG 14 to 12)	8.5 to 11
	CE3057-10A-1-D			10.5 to 14.1		
General environment (Note 2)	D/MS3106B18-10S		D/MS3057-10A	2.2 mm <sup>2</sup> to 3.5 mm <sup>2</sup> (AWG 14 to 12)	14.3 or smaller (bushing ID)	
	HG-SN202J, 302J		IP67 EN compliant	CE05-6A22-22SD-D-BSS	CE3057-12A-2-D	5.5 mm <sup>2</sup> to 8 mm <sup>2</sup> (AWG 10 to 8)
General environment (Note 2)		D/MS3106B22-22S	D/MS3057-12A		12.5 to 16	
	HG-SN52J, 102J, 152J	IP67 EN compliant	Angle	CE05-8A18-10SD-D-BAS	CE3057-10A-2-D	2.2 mm <sup>2</sup> to 3.5 mm <sup>2</sup> (AWG 14 to 12)
General environment (Note 2)		CE3057-10A-1-D			10.5 to 14.1	
	HG-SN202J, 302J	IP67 EN compliant		CE05-8A22-22SD-D-BAS	CE3057-12A-2-D	5.5 mm <sup>2</sup> to 8 mm <sup>2</sup> (AWG 10 to 8)
General environment (Note 2)		D/MS3108B18-10S			D/MS3057-10A	
	HG-SN202J, 302J	IP67 EN compliant	D/MS3108B22-22S	D/MS3057-12A	5.5 mm <sup>2</sup> to 8 mm <sup>2</sup> (AWG 10 to 8)	15.9 or smaller (bushing ID)
General environment (Note 2)		D/MS3108B22-22S		D/MS3057-12A	5.5 mm <sup>2</sup> to 8 mm <sup>2</sup> (AWG 10 to 8)	15.9 or smaller (bushing ID)

Notes: 1. The IP rating indicated is for the connector's protection against ingress of dust and water when coupled to a servo amplifier/servo motor. If the IP rating of the servo amplifier/servo motor differs from that of these connectors, overall IP rating depends on the lowest of all.

2. Not compliant with EN.

3. The wire size shows wiring specification of the connector. Refer to "Selection Example in HIV Wires for Servo Motors" in this catalog for examples of wire size selection.

4. Contact Taisei Co., Ltd.

## Products on the Market for Servo Motors

Contact the relevant manufacturers directly.

When fabricating a cable with the following connectors, refer to the relevant manufacturers' instruction manuals for wiring and assembling procedures.

### Electromagnetic brake connector for HG-KN series



Applicable servo motor	Feature <sup>(Note 1)</sup>	Connector (Japan Aviation Electronics Industry, Limited)	Crimping tool (Japan Aviation Electronics Industry, Limited)	Applicable cable example
HG-KN	IP65	Plug: JN4FT02SJ1-R Socket contact: ST-TMH-S-C1B-100-(A534G)	For contactor: CT170-14-TMH5B	Wire size: 0.3 mm <sup>2</sup> to 0.5 mm <sup>2</sup> (AWG 22 to 20) Cable OD: 3.6 mm to 4.8 mm Wire example: Fluorine resin wire (Vinyl jacket cable RMFES-A (CL3X) AWG 20, 2 cores Dyden Corporation <sup>(Note 2)</sup> or an equivalent product)

Straight type      Angle type

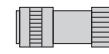

### Electromagnetic brake connector for HG-SN series

Applicable servo motor	Feature <sup>(Note 1)</sup>	Connector (DDK Ltd.)				Applicable cable example Cable OD [mm]
		Type	Type of connection	Plug	Socket contact	
HG-SN	IP67	Straight	One-touch connection type	CMV1-SP2S-S	Select from solder or press bonding type. (Refer to the table below.)	4.0 to 6.0
				CMV1-SP2S-M1		5.5 to 7.5
				CMV1-SP2S-M2		7.0 to 9.0
				CMV1-SP2S-L		9.0 to 11.6
			Screw type	CMV1S-SP2S-S		4.0 to 6.0
				CMV1S-SP2S-M1		5.5 to 7.5
				CMV1S-SP2S-M2		7.0 to 9.0
				CMV1S-SP2S-L		9.0 to 11.6
		Angle	One-touch connection type	CMV1-AP2S-S		4.0 to 6.0
				CMV1-AP2S-M1		5.5 to 7.5
				CMV1-AP2S-M2		7.0 to 9.0
				CMV1-AP2S-L		9.0 to 11.6
			Screw type	CMV1S-AP2S-S		4.0 to 6.0
				CMV1S-AP2S-M1		5.5 to 7.5
				CMV1S-AP2S-M2		7.0 to 9.0
				CMV1S-AP2S-L		9.0 to 11.6

Contact	Socket contact (DDK Ltd.)	Wire size <sup>(Note 3)</sup>
Solder type	CMV1-#22BSC-S2-100	1.25 mm <sup>2</sup> (AWG 16) or smaller
Press bonding type	CMV1-#22BSC-C3-100	0.5 mm <sup>2</sup> to 1.25 mm <sup>2</sup> (AWG 20 to 16) Crimping tool (357J-53164T) is required.

Notes: 1. The IP rating indicated is for the connector's protection against ingress of dust and water when coupled to a servo amplifier/servo motor. If the IP rating of the servo amplifier/servo motor differs from that of these connectors, overall IP rating depends on the lowest of all.

2. Contact Taisei Co., Ltd.

3. The wire size shows wiring specification of the connector. Refer to "Selection Example in HIV Wires for Servo Motors" in this catalog for examples of wire size selection.

## Configuration Example for MR-JE-C

C

1 kW or smaller

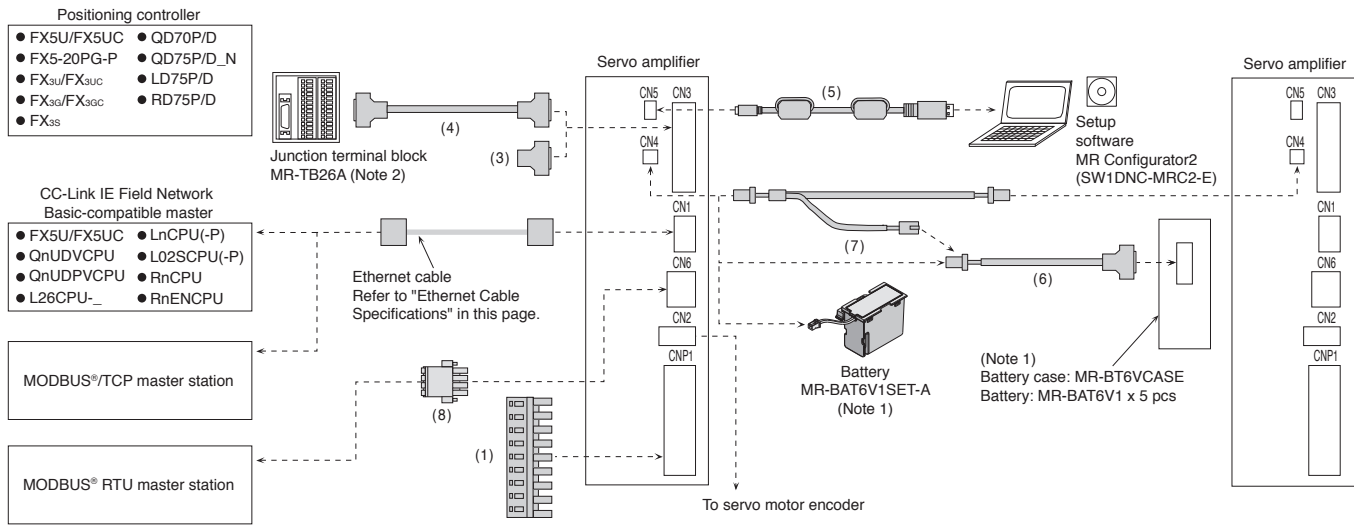

2 kW and 3 kW

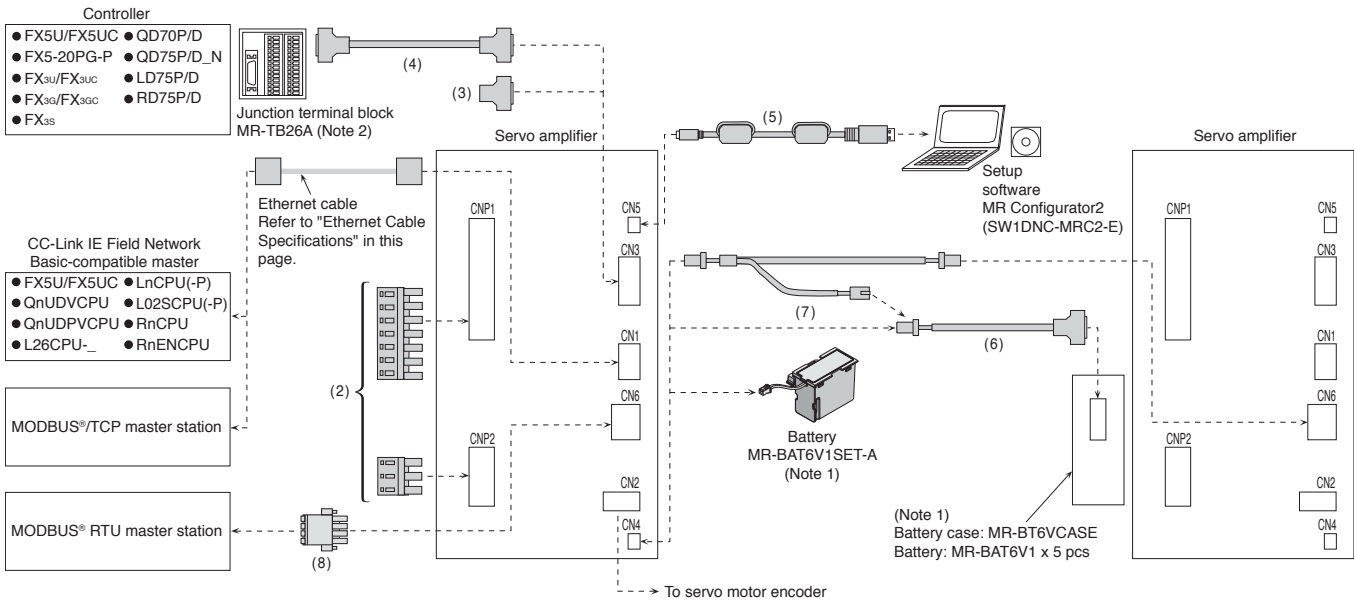













Notes: 1. Refer to "Battery" or "Battery Case and Battery" in this catalog. Battery and battery case are not required when the MR-JE-C servo amplifier is used in incremental system.  
2. Refer to "Junction Terminal Block" in this catalog.

### Ethernet Cable Specifications (Note 1, 2)

Item	Description
Ethernet Cable	Category 5e or higher, (STP) straight cable
	The cable must meet the following:
	<ul style="list-style-type: none"> <li>• IEEE802.3 (1000BASE-T)</li> <li>• ANSI/TIA/EIA-568-B (Category 5e)</li> </ul>
Connector	RJ-45 connector with shield

Notes: 1. Use the cable which meets the above specifications for Ethernet wiring.  
2. Cables for CC-Link IE Controller Network cannot be used with CC-Link IE Field Network Basic.

## Cables and Connectors for MR-JE-C

	Item	Model	Cable length	IP rating	Application	Description
For CNP1	(1) Servo amplifier CNP1 power connector	MR-JECNP1-01 (Standard accessory)	-	-	For MR-JE-100C or smaller	 CNP1 connector Open tool  Applicable wire size (Note 1): AWG 18 to 14 Insulator OD: 3.9 mm or smaller
	For CNP1/CNP2	Servo amplifier CNP1 power connector	MR-JECNP1-02 (Standard accessory)	-	-	For MR-JE-200C/ MR-JE-300C
Servo amplifier CNP2 power connector		MR-JECNP2-02 (Standard accessory)	-	-	 CNP2 connector Applicable wire size (Note 1): AWG 16 to 10 Insulator OD: 4.7 mm or smaller	
For CN3	Connector set (Qty: 1 pc)	MR-J2CMP2	-	-	For MR-JE-C	 Servo amplifier connector
	Connector set (Qty: 20 pcs)	MR-ECN1	-	-	For MR-JE-C	
	(4) Junction terminal block cable	MR-TBNATBL05M MR-TBNATBL1M	0.5 m 1 m	-	For connecting MR-JE-C and MR-TB26A	 Junction terminal block connector  Servo amplifier connector
For CN5	(5) Personal computer communication cable (USB cable)	MR-J3USBCBL3M	3 m	-	For MR-JE-C	 Servo amplifier connector mini-B connector (5-pin)  Personal computer connector A connector
For CN4	(6) Battery cable	MR-BT6V1CBL03M	0.3 m	-	For connecting MR-JE-C and MR-BT6VCASE	 Servo amplifier connector  Battery case connector
		MR-BT6V1CBL1M	1 m			
	(7) Junction battery cable	MR-BT6V2CBL03M	0.3 m	-	For MR-JE-C	 Servo amplifier connector  Junction connector
		MR-BT6V2CBL1M	1 m			
For CN6	(8) RS-485 communication connector	(Standard accessory)	-	-	For MR-JE-C	 RS-485 communication connector

Notes: 1. The wire size shows wiring specification of the connector. Refer to "Selection Example in HIV Wires for Servo Motors" in this catalog for examples of wire size selection.

## Configuration Example for MR-JE-B (Note 2)

B

1 kW or smaller

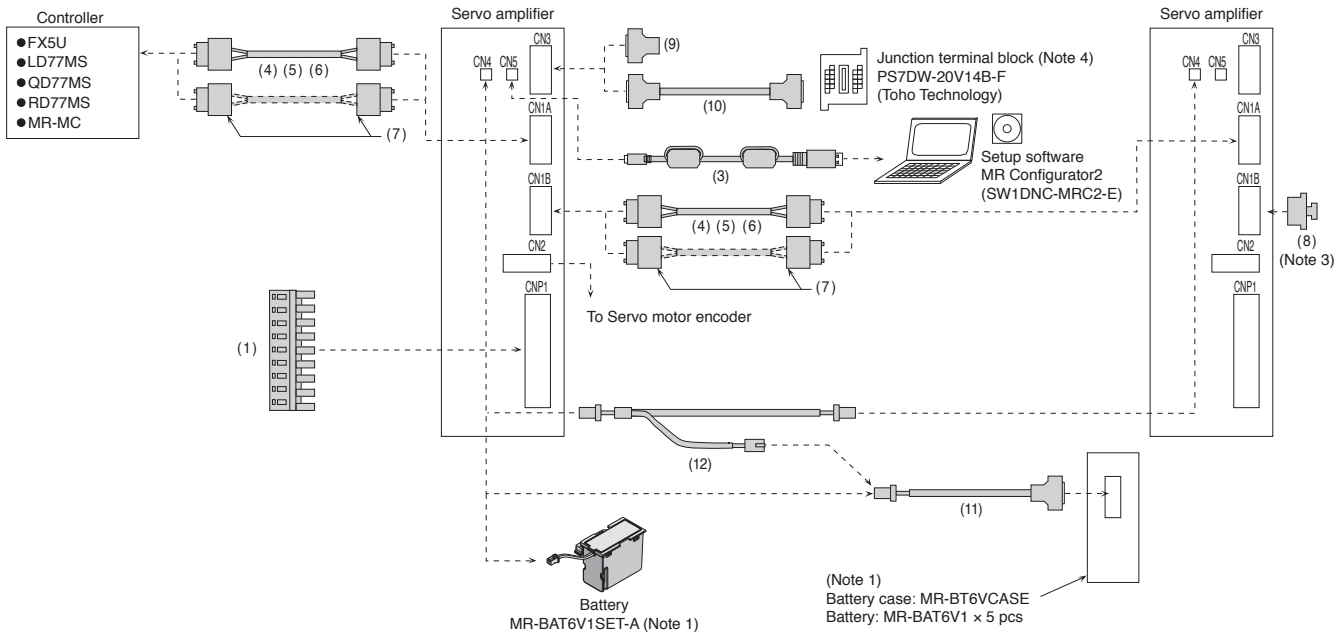

2 kW and 3 kW

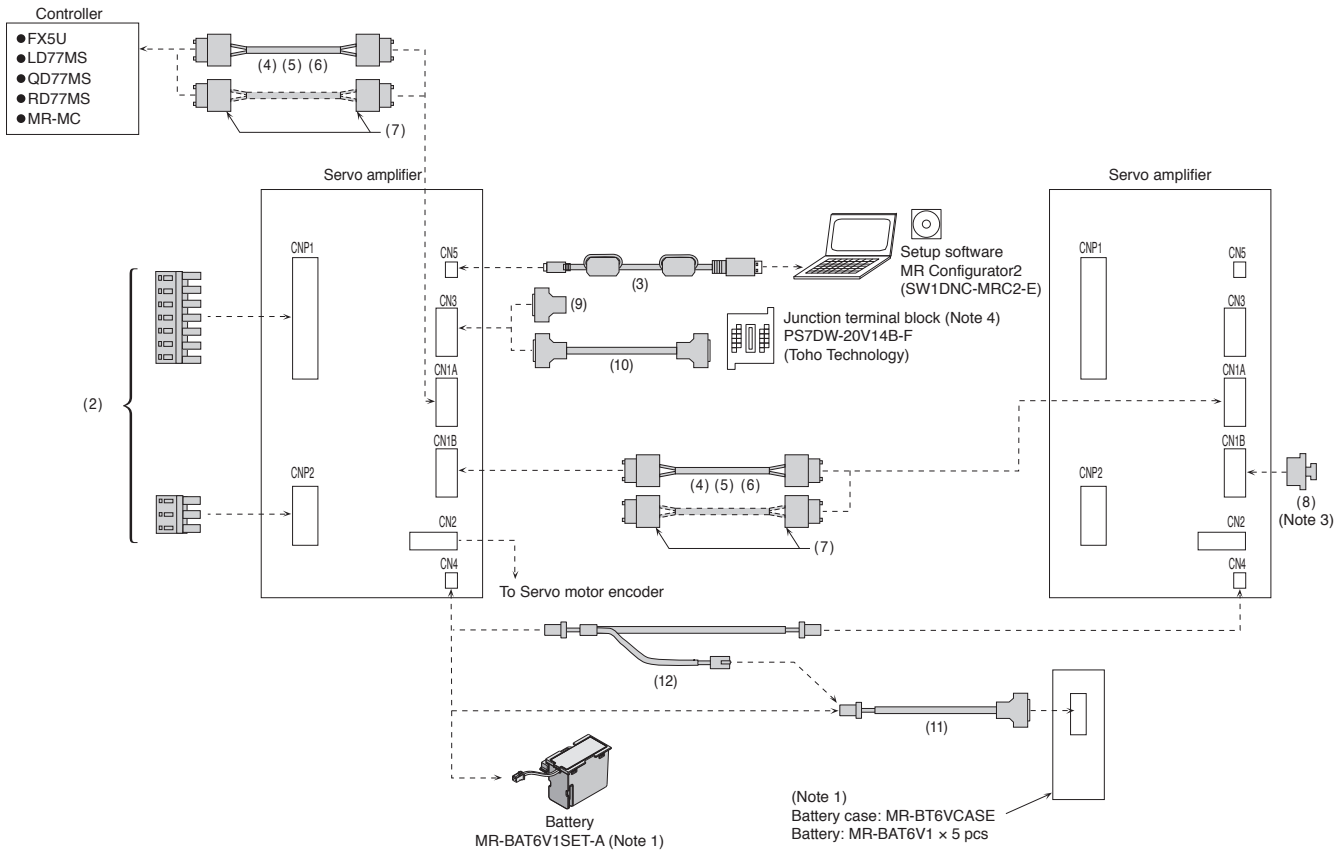











- Notes: 1. Refer to "Battery" or "Battery Case and Battery" in this catalog. Battery and battery case are not required when the MR-JE-B servo amplifier is used in incremental system.  
 2. Cables drawn with dashed lines need to be fabricated by user. Refer to relevant Servo Amplifier Instruction Manual for fabricating the cables.  
 3. Be sure to attach a cap to CN1B connector of the final axis.  
 4. Refer to "Junction Terminal Block" in this catalog.

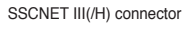

## Cables and Connectors for MR-JE-B

Refer to "Details of Option Connectors for Servo Amplifiers" in this catalog for the detailed models.

	Item	Model	Cable length	IP rating	Application	Description
For CNP1	(1) Servo amplifier CNP1 power connector	MR-JECNP1-01 (Standard accessory)	-	-	For MR-JE-100B or smaller	  Applicable wire size (Note 1): AWG 18 to 14 Insulator OD: 3.9 mm or smaller
	For CNP1/CNP2	(2) Servo amplifier CNP1 power connector	MR-JECNP1-02 (Standard accessory)	-	-	For MR-JE-200B/ MR-JE-300B
Servo amplifier CNP2 power connector		MR-JECNP2-02 (Standard accessory)	-	-	 Applicable wire size (Note 1): AWG 16 to 10 Insulator OD: 4.7 mm or smaller	
For CNS	(3) Personal computer communication cable (USB cable)	MR-J3USBCBL3M	3 m	-	For MR-JE-B	  * Do not use this cable for SSCNET III(H)-compatible controller.
For controller/CN1A/CN1B	(4) SSCNET III cable (Note 2) (standard cord inside cabinet) Compatible with SSCNET III(H)	MR-J3BUS015M	0.15 m	-	For MR-JE-B	 
		MR-J3BUS03M	0.3 m	-		
		MR-J3BUS05M	0.5 m	-		
		MR-J3BUS1M	1 m	-		
		MR-J3BUS3M	3 m	-		
	(5) SSCNET III cable (Note 2) (standard cable outside cabinet) Compatible with SSCNET III(H)	MR-J3BUS5M-A <sup>*1</sup>	5 m	-	For MR-JE-B	
		MR-J3BUS10M-A <sup>*1</sup>	10 m	-		
		MR-J3BUS20M-A <sup>*1</sup>	20 m	-		
	(6) SSCNET III cable (Note 2, 4) (long distance cable, long bending life) Compatible with SSCNET III(H)	MR-J3BUS30M-B <sup>*1</sup>	30 m	-	For MR-JE-B	
		MR-J3BUS40M-B <sup>*1</sup>	40 m	-		
MR-J3BUS50M-B <sup>*1</sup>	50 m	-				
(7) SSCNET III connector set (Note 2, 3) Compatible with SSCNET III(H)	MR-J3BCN1	-	-	For MR-JE-B	 	
For CN1B	(8) SSCNET III connector cap Compatible with SSCNET III(H)	(Standard accessory)	-	-	For MR-JE-B	

- Notes: 1. The wire size shows wiring specification of the connector. Refer to "Selection Example in HIV Wires for Servo Motors" in this catalog for examples of wire size selection.  
 2. Read carefully through the precautions enclosed with the options before use.  
 3. Dedicated tools are required. Contact your local sales office for more details.  
 4. When SSCNET III/H is used, refer to "Products on the Market for Servo Amplifiers" in this catalog for cables over 50 m or with ultra-long bending life.

For unlisted lengths

\*1. For unlisted lengths of the cables, please contact Mitsubishi Electric System &amp; Service Co., Ltd. OVERSEAS SERVICE SECTION (Email: osb.webmaster@melsc.jp)

## Cables and Connectors for MR-JE-B

**B**

Refer to "Details of Option Connectors for Servo Amplifiers" in this catalog for the detailed models.

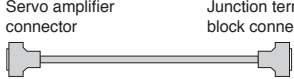
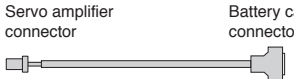
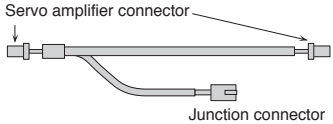
	Item	Model	Cable length	IP rating	Application	Description
For CN3	(9) Connector set	MR-CCN1	-	-	For MR-JE-B	 Servo amplifier connector
	(10) Junction terminal block cable	MR-J2HBUS05M	0.5 m	-	For connecting MR-JE-B and PS7DW-20V14B-F	
		MR-J2HBUS1M	1 m			
		MR-J2HBUS5M	5 m			
For CN4	(11) Battery cable	MR-BT6V1CBL03M	0.3 m	-	For connecting MR-JE-B and MR-BT6VCASE	
		MR-BT6V1CBL1M	1 m			
	(12) Junction battery cable	MR-BT6V2CBL03M	0.3 m	-	For MR-JE-B	
		MR-BT6V2CBL1M	1 m			

Configuration Example for MR-JE-A (Note 2)

1 kW or smaller

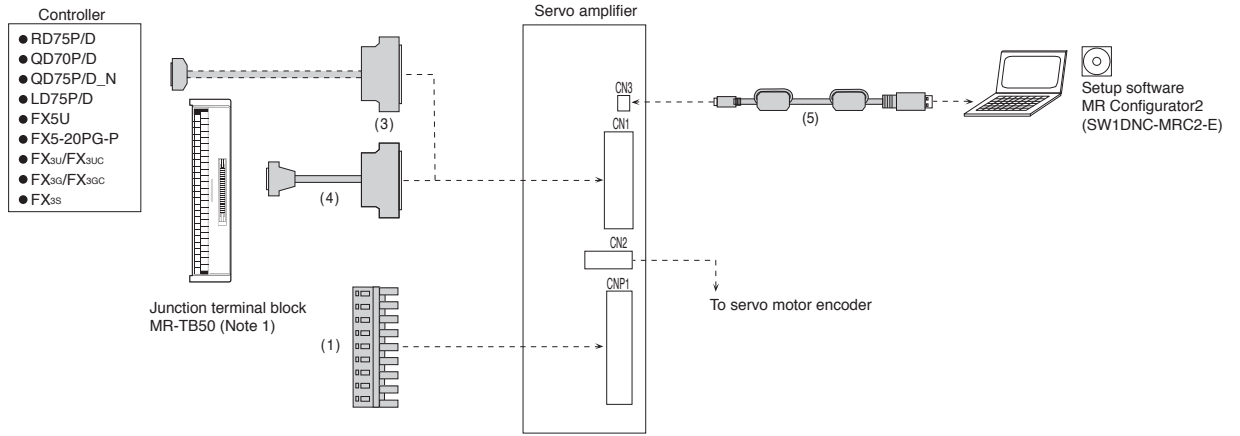

2 kW and 3 kW

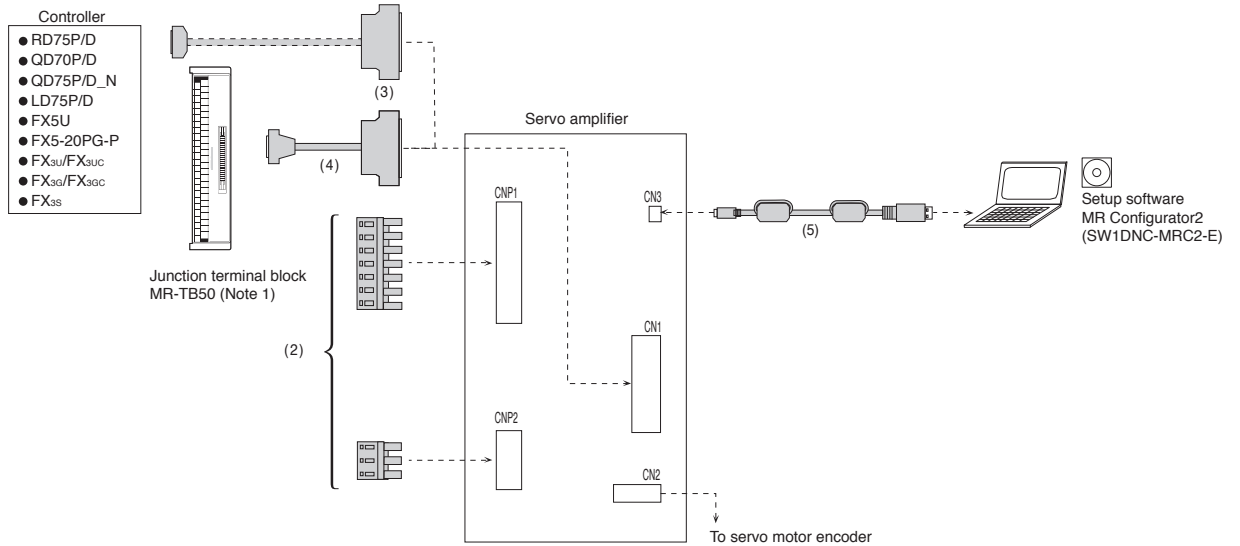









Notes: 1. Refer to "Junction Terminal Block" in this catalog.

2. Cables drawn with dashed lines need to be fabricated by user. Refer to relevant Servo Amplifier Instruction Manual for fabricating the cables.













## Cables and Connectors for MR-JE-A

Refer to "Details of Option Connectors for Servo Amplifiers" in this catalog for the detailed models.

	Item	Model	Cable length	IP rating	Application	Description
For CNP1	(1) Servo amplifier CNP1 power connector	MR-JECNP1-01 (Standard accessory)	-	-	For MR-JE-100A or smaller	<p>CNP1 connector  Open tool </p> <p>Applicable wire size <sup>(Note 1)</sup>: AWG 18 to 14 Insulator OD: 3.9 mm or smaller</p>
	(2) Servo amplifier CNP1 power connector	MR-JECNP1-02 (Standard accessory)	-	-	For MR-JE-200A/ MR-JE-300A	<p>CNP1 connector  Open tool </p> <p>Applicable wire size <sup>(Note 1)</sup>: AWG 16 to 10 Insulator OD: 4.7 mm or smaller</p>
For CNP1/CNP2	Servo amplifier CNP2 power connector	MR-JECNP2-02 (Standard accessory)	-	-		
	(3) Connector set	MR-J3CN1	-	-	For MR-JE-A	<p> Servo amplifier connector</p>
For CN1	(4) Junction terminal block cable	MR-J2M-CN1TBL05M	0.5 m	-	For connecting MR-JE-A and MR-TB50	<p>Junction terminal block connector  Servo amplifier connector </p>
		MR-J2M-CN1TBL1M	1 m			
For CN3	(5) Personal computer communication cable (USB cable)	MR-J3USBCBL3M	3 m	-	For MR-JE-A	<p>Servo amplifier connector mini-B connector (5-pin)  Personal computer connector A connector </p>

Notes: 1. The wire size shows wiring specification of the connector. Refer to "Selection Example in HIV Wires for Servo Motors" in this catalog for examples of wire size selection.











## Details of Option Connectors for Servo Amplifiers

Model	CNP1 connector	Open tool
MR-JECNP1-01 (Standard accessory)	 09JFAT-SAXGDK-H5.0 (J.S.T. Mfg. Co., Ltd.)	 J-FAT-OT (N) (J.S.T. Mfg. Co., Ltd.)
MR-JECNP1-02 (Standard accessory)	 06(7-4)JFAT-SAXGFK-XL (J.S.T. Mfg. Co., Ltd.)	 J-FAT-OT-EXL (J.S.T. Mfg. Co., Ltd.)
Model	CNP2 connector	
MR-JECNP2-02 (Standard accessory)	 03JFAT-SAXGFK-XL (J.S.T. Mfg. Co., Ltd.)	
Model	Servo amplifier connector	
MR-J2CMP2 MR-ECN1	 Connector: 10126-3000PE Shell kit: 10326-52F0-008 (3M) or an equivalent product	
Model	Junction terminal block connector	Servo amplifier connector
MR-TBNATBL_M	 Connector: 10126-6000EL Shell kit: 10326-3210-000 (3M) or an equivalent product	 Connector: 10126-6000EL Shell kit: 10326-3210-000 (3M) or an equivalent product
Model	Servo amplifier connector	Battery case connector
MR-BT6V1CBL_M	 Contact: SPHD-001G-P0.5 Housing: PAP-02V-O (J.S.T. Mfg. Co., Ltd.)	 Solder type <sup>(Note 1)</sup> Connector: 10114-3000PE Shell kit: 10314-52F0-008 (3M) or an equivalent product
Model	Servo amplifier connector	Junction connector
MR-BT6V2CBL_M	 Contact: SPHD-001G-P0.5 Housing: PAP-02V-O (J.S.T. Mfg. Co., Ltd.)	 Contact: SPAL-001GU-P0.5 Housing: PALR-02VF-O (J.S.T. Mfg. Co., Ltd.)
Model	RS-485 communication connector	
RS-485 communication connector for MR-JE-_C (Standard accessory)	 Contact: DFMC 1,5/ 4-STF-3,5 2BDSLQ QSO (Phoenix Contact) or an equivalent product	

Notes: 1. Press bonding type (connector: 101114-6000EL, shell kit: 10314-3210-000) (3M) is also usable. Contact the manufacture directly.

## Options/Peripheral Equipment

### Details of Option Connectors for Servo Amplifiers

Model	SSCNET III(/H) connector	SSCNET III(/H) connector
MR-J3BUS_M MR-J3BUS_M-A MR-J3BCN1	 Connector: PF-2D103 (Japan Aviation Electronics Industry, Limited)	 Connector: PF-2D103 (Japan Aviation Electronics Industry, Limited)
Model	SSCNET III(/H) connector	SSCNET III(/H) connector
MR-J3BUS_M-B	 Connector: CF-2D103-S (Japan Aviation Electronics Industry, Limited)	 Connector: CF-2D103-S (Japan Aviation Electronics Industry, Limited)
Model	Servo amplifier connector	
MR-CCN1		Solder type <sup>(Note 1)</sup> Connector: 10120-3000PE Shell kit: 10320-52F0-008 (3M) or an equivalent product
Model	Servo amplifier connector	Junction terminal block connector
MR-J2HBUS_M	 Connector: 52316-2019 Shell kit: 52370-2070 (Molex) or an equivalent product or Press bonding type <sup>(Note 2)</sup> Connector: 10120-6000EL Shell kit: 10320-3210-000 (3M) or an equivalent product	 Connector: 52316-2019 Shell kit: 52370-2070 (Molex) or an equivalent product or Press bonding type <sup>(Note 2)</sup> Connector: 10120-6000EL Shell kit: 10320-3210-000 (3M) or an equivalent product
Model	Servo amplifier connector	
MR-J3CN1		Connector: 10150-3000PE Shell kit: 10350-52F0-008 (3M) or an equivalent product
Model	Junction terminal block connector	Servo amplifier connector
MR-J2M-CN1TBL_M	 Connector: D7950-B500FL (3M)	 Press bonding type <sup>(Note 3)</sup> Connector: 10150-6000EL Shell kit: 10350-3210-000 (3M)

Notes: 1. Press bonding type (connector: 10120-6000EL and shell kit: 10320-3210-000) (3M) is also usable. Contact the manufacturer directly.

2. Solder type (connector: 10120-3000PE and shell kit: 10320-52F0-008) (3M) is also usable. Contact the manufacturer directly.

3. Solder type (connector: 10150-3000PE and shell kit: 10350-52F0-008) (3M) is also usable. Contact the manufacturer directly.

## Products on the Market for Servo Amplifiers

## SSCNET III cable

B

Application	Model	Description
Ultra-long bending life fiber-optic cable for SSCNET III(/H)	SC-J3BUS_M-C _ = cable length (100 m maximum <sup>(Note 1)</sup> , unit of 1 m)	 Mitsubishi Electric System & Service Co., Ltd.

Notes: 1. The maximum wiring distance between stations is 100 m for SSCNET III/H and 50 m for SSCNET III.

## Application of connecting encoder junction cable

C

B

A

Unlisted lengths of cables between servo amplifier and servo motor, EMC cables, and special cables for connecting servo amplifier and servo motor with multiple cables are available. Please contact Mitsubishi Electric System & Service Co., Ltd. OVERSEAS SERVICE SECTION (Email: [osb.webmaster@melsc.jp](mailto:osb.webmaster@melsc.jp))

Example) Configuration using three encoder junction cables

- Replacing only the cable of the moving part in the cable chain is possible.
- Resetting after transporting a machine is easy because the servo amplifier side and the servo motor side can be separated.

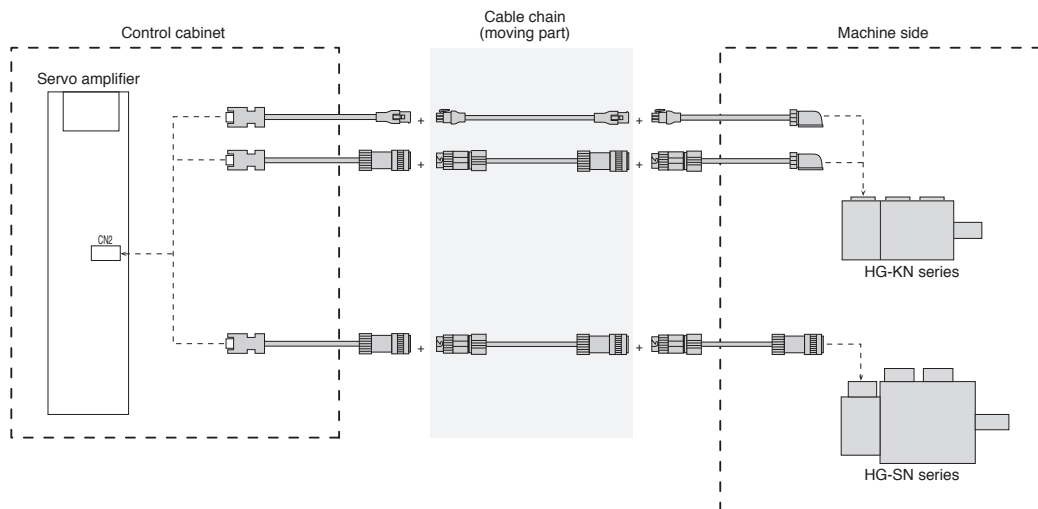

## Regenerative Option

C B A

Servo amplifier model	Permissible regenerative power [W] <sup>(Note 2)</sup>					
	Built-in regenerative resistor	Regenerative option				
		MR-RB032	MR-RB12	MR-RB30	MR-RB32	MR-RB50 <sup>(Note 1)</sup>
		40 Ω	40 Ω	13 Ω	40 Ω	13 Ω
MR-JE-10C/B/A	-	30	-	-	-	-
MR-JE-20C/B/A	-	30	100	-	-	-
MR-JE-40C/B/A	10	30	100	-	-	-
MR-JE-70C/B/A	20	30	100	-	300	-
MR-JE-100C/B/A	20	30	100	-	300	-
MR-JE-200C/B/A	100	-	-	300	-	500
MR-JE-300C/B/A	100	-	-	300	-	500

Notes: 1. Be sure to cool the unit forcibly with a cooling fan (92 mm × 92 mm, minimum air flow: 1.0 m<sup>3</sup>/min). The cooling fan must be prepared by user.

2. The power values in this table are resistor-generated powers, not rated powers.

## \* Cautions when connecting the regenerative option

1. The regenerative option causes a temperature rise of 100 °C or higher relative to the ambient temperature. Fully examine heat dissipation, installation position, wires used before installing the unit. Use flame-retardant wires or apply flame retardant on wires, and keep the wires clear of the unit.
2. Use twisted wires for connecting the regenerative option to the servo amplifier, and keep the wire length to a maximum of 5 m.
3. Use twisted wires for connecting a thermal sensor, and make sure that the sensor does not fail to work properly due to inducted noise.



Regenerative Option

C B A

Dimensions	Connections									
<p>MR-RB032</p> <p>Terminal arrangement</p> <table border="1"> <tr><td>TE1</td></tr> <tr><td>G3</td></tr> <tr><td>G4</td></tr> <tr><td>P</td></tr> <tr><td>C</td></tr> </table> <p>Applicable wire size (Note 5): 0.2 mm<sup>2</sup> to 2.5 mm<sup>2</sup> (AWG 24 to 12) Mounting screw size: M5</p> <table border="1"> <thead> <tr><th>Model</th><th>Mass [kg]</th></tr> </thead> <tbody> <tr><td>MR-RB032</td><td>0.5</td></tr> </tbody> </table>	TE1	G3	G4	P	C	Model	Mass [kg]	MR-RB032	0.5	<p>Connections</p>
TE1										
G3										
G4										
P										
C										
Model	Mass [kg]									
MR-RB032	0.5									
<p>MR-RB12</p> <p>Terminal arrangement</p> <table border="1"> <tr><td>TE1</td></tr> <tr><td>G3</td></tr> <tr><td>G4</td></tr> <tr><td>P</td></tr> <tr><td>C</td></tr> </table> <p>Applicable wire size (Note 5): 0.2 mm<sup>2</sup> to 2.5 mm<sup>2</sup> (AWG 24 to 12) Mounting screw size: M5</p> <table border="1"> <thead> <tr><th>Model</th><th>Mass [kg]</th></tr> </thead> <tbody> <tr><td>MR-RB12</td><td>1.1</td></tr> </tbody> </table>	TE1	G3	G4	P	C	Model	Mass [kg]	MR-RB12	1.1	<p>Connections</p>
TE1										
G3										
G4										
P										
C										
Model	Mass [kg]									
MR-RB12	1.1									
<p>MR-RB30, MR-RB32</p> <p>Terminal arrangement</p> <table border="1"> <tr><td>P</td></tr> <tr><td>C</td></tr> <tr><td>G3</td></tr> <tr><td>G4</td></tr> </table> <p>Terminal screw size: M4 Mounting screw size: M6</p> <table border="1"> <thead> <tr><th>Model</th><th>Mass [kg]</th></tr> </thead> <tbody> <tr><td>MR-RB30</td><td rowspan="2">2.9</td></tr> <tr><td>MR-RB32</td></tr> </tbody> </table>	P	C	G3	G4	Model	Mass [kg]	MR-RB30	2.9	MR-RB32	<p>For 1 kW or smaller</p>
P										
C										
G3										
G4										
Model	Mass [kg]									
MR-RB30	2.9									
MR-RB32										
<p>MR-RB50</p> <p>Terminal arrangement</p> <table border="1"> <tr><td>P</td></tr> <tr><td>G3</td></tr> <tr><td>G4</td></tr> </table> <p>Terminal screw size: M4 Mounting screw size: M6</p> <table border="1"> <thead> <tr><th>Model</th><th>Mass [kg]</th></tr> </thead> <tbody> <tr><td>MR-RB50</td><td>5.6</td></tr> </tbody> </table>	P	G3	G4	Model	Mass [kg]	MR-RB50	5.6	<p>For 2 kW or larger</p>		
P										
G3										
G4										
Model	Mass [kg]									
MR-RB50	5.6									

- Notes:
1. Create a sequence circuit that turns off the magnetic contactor when abnormal overheating occurs.
  2. When using MR-RB50, cool the unit forcibly with a cooling fan (92 mm × 92 mm, minimum air flow: 1.0 m<sup>3</sup>/min). The cooling fan must be prepared by user.
  3. When using MR-RB30 or MR-RB32, it may be necessary to cool the unit forcibly with a cooling fan (92 mm × 92 mm, minimum air flow: 1.0 m<sup>3</sup>/min), depending on the operating environment. Refer to relevant Servo Amplifier Instruction Manual for details. The cooling fan must be prepared by user.
  4. G3 and G4 terminals are thermal sensor. G3-G4 opens when the regenerative option overheats abnormally.
  5. The wire size shows wiring specification of the connector. Refer to "Wires, Molded-Case Circuit Breakers and Magnetic Contactors" in this catalog for examples of wire size selection.
  6. MR-JE-10C/MR-JE-10B/MR-JE-10A and MR-JE-20C/MR-JE-20B/MR-JE-20A do not have the built-in regenerative resistor.

# Options/Peripheral Equipment

## Battery (MR-BAT6V1SET-A) (Note1)

C B

The absolute position data can be retained when the battery is mounted on the servo amplifier. When the battery life runs out, please replace the built-in MR-BAT6V1 battery.

MR-BAT6V1SET-A is not required for the incremental system.

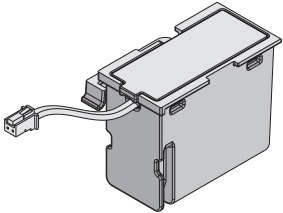
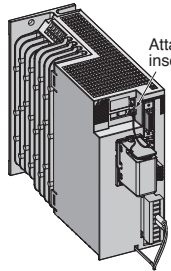
Appearance	Mounting method
 <p>Model: MR-BAT6V1SET-A            Nominal voltage: 6 V            Nominal capacity: 1650 mAh            Lithium content: 1.2 g            Primary battery: 2CR17335A            (CR17335A x 2 pcs. in series)            Mass: 55 g</p>	 <p>Attach the battery, and then insert the plug to CN4 connector.</p> <p>* MR-J3BAT battery cannot be used because of the difference in voltage.</p>

## Battery Case (MR-BT6VCASE ), Battery (MR-BAT6V1) (Note 1)

C B

Absolute position data of up to eight axes of the servo motors can be retained when the battery case and the batteries are used. The servo motors used in incremental system are also included in the number of the connectable axes.

The case stores five batteries by connecting to the connectors. The batteries are not included in the battery case. Please purchase the batteries separately.

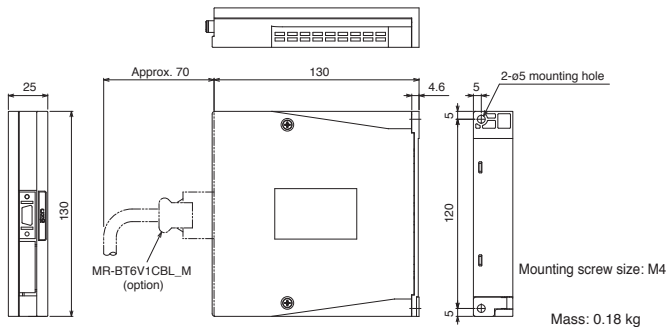
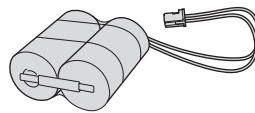
Dimensions (assembled)	MR-BAT6V1
 <p>[Unit: mm]</p> <p>Mounting screw size: M4</p> <p>Mass: 0.18 kg</p>	 <p>Model: MR-BAT6V1            Nominal voltage: 6 V            Nominal capacity: 1650 mAh            Lithium content: 1.2 g            Primary battery: 2CR17335A (CR17335A x 2 pcs. in series)            Mass: 34 g</p>

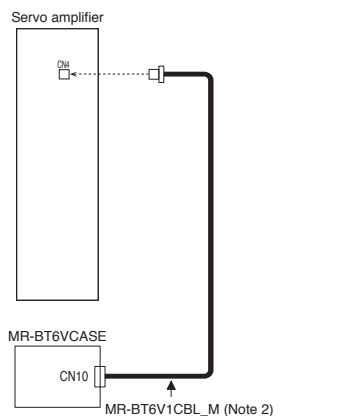
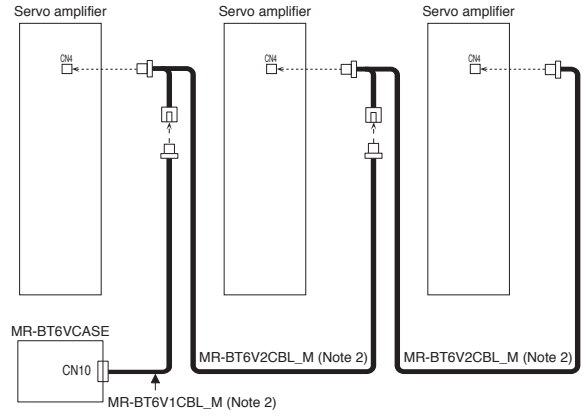
Connections	
<p>For connecting to one unit of servo amplifier</p> 	<p>For connecting up to eight servo amplifier axes</p> 

- Notes: 1. MR-BAT6V1 and MR-BAT6V1SET-A are assembled batteries composed of lithium metal batteries of CR17335A. This battery is not subject to the dangerous goods (Class 9) of the UN Recommendations. To transport lithium metal batteries and lithium metal batteries contained in equipment, take actions to comply with the following regulations: the United Nations Recommendations on the Transport of Dangerous Goods, the Technical Instruction (ICAO-TI) by the International Civil Aviation Organization (ICAO), and the International Maritime Dangerous Goods Code (IMDG Code) by the International Maritime Organization (IMO). To transport the batteries, check the latest standards or the laws of the destination country and take actions. Contact your local sales office for more details.
2. This is an option cable. Refer to "Cables and Connectors for MR-JE-C" or "Cables and Connectors for MR-JE-B" in this catalog.

### Junction Terminal Block (MR-TB26A)

Connect all signals via the junction terminal block.

C

Dimensions (Note 1)		[Unit: mm]																
	<p><b>Specifications</b></p> <table border="1" style="width: 100%; border-collapse: collapse;"> <tr> <td style="width: 20%;">Rating</td> <td colspan="2">32 V AC/DC, 0.5 A</td> </tr> <tr> <td rowspan="3">Applicable wire (terminal side)</td> <td>Stranded wire</td> <td>0.08 mm<sup>2</sup> to 1.5 mm<sup>2</sup> (AWG 28 to 14)</td> </tr> <tr> <td>Solid wire</td> <td>ø0.32 mm to 1.2 mm</td> </tr> <tr> <td>Insulator OD</td> <td>3.4 mm or shorter</td> </tr> <tr> <td>Operating tool</td> <td colspan="2">210-619 (WAGO) or an equivalent 210-119SB (WAGO) or an equivalent</td> </tr> <tr> <td>Strip length</td> <td colspan="2">5 mm to 6 mm</td> </tr> </table>	Rating	32 V AC/DC, 0.5 A		Applicable wire (terminal side)	Stranded wire	0.08 mm <sup>2</sup> to 1.5 mm <sup>2</sup> (AWG 28 to 14)	Solid wire	ø0.32 mm to 1.2 mm	Insulator OD	3.4 mm or shorter	Operating tool	210-619 (WAGO) or an equivalent 210-119SB (WAGO) or an equivalent		Strip length	5 mm to 6 mm		
Rating	32 V AC/DC, 0.5 A																	
Applicable wire (terminal side)	Stranded wire	0.08 mm <sup>2</sup> to 1.5 mm <sup>2</sup> (AWG 28 to 14)																
	Solid wire	ø0.32 mm to 1.2 mm																
	Insulator OD	3.4 mm or shorter																
Operating tool	210-619 (WAGO) or an equivalent 210-119SB (WAGO) or an equivalent																	
Strip length	5 mm to 6 mm																	

Notes: 1. The lengths in brackets are applicable when the junction terminal block is mounted on a 35 mm wide DIN rail.

### [Products on the Market]

### Junction Terminal Block (PS7DW-20V14B-F)

Connect all signals via the junction terminal block.

B

External appearance	
	<p>Toho Technology Kyoto Factory Applicable wire: 1.25 mm<sup>2</sup> maximum</p>

### Junction Terminal Block (MR-TB50)

Connect all signals via the junction terminal block.

A

Dimensions		[Unit: mm]
	<p>Terminal screw size: M3.5 Applicable wire: 2 mm<sup>2</sup> maximum Crimp terminal width: 7.2 mm or shorter Mounting screw size: M4</p>	

## Radio Noise Filter (FR-BIF)

C B A

This filter suppresses noise from the power supply side of the servo amplifier, especially effective for the radio frequency bands of 10 MHz or lower. The FR-BIF is designed to be installed on the input side.

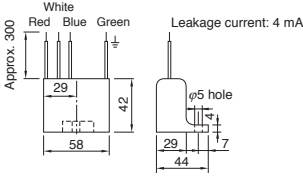
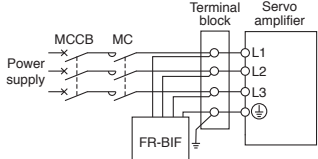
Dimensions [Unit: mm]	Connections
 <p>Approx. 300 White Red Blue Green Leakage current: 4 mA φ5 hole</p>	<p>Do not use the FR-BIF on the output side of the servo amplifier. Wiring should be as short as possible, and grounding is required. Be sure to insulate the unused wire when using the FR-BIF with a 1-phase power supply.</p> 

## Line Noise Filter (FR-BSF01)

C B A

This filter suppresses radio noise from the power supply side and the output side of the servo amplifier. The FR-BSF01 is also effective in suppressing high-frequency leakage current (zero-phase current), especially the range of 0.5 MHz and 5 MHz.

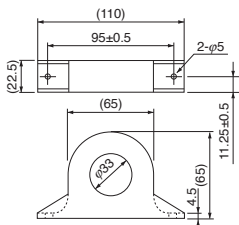
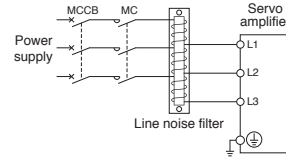
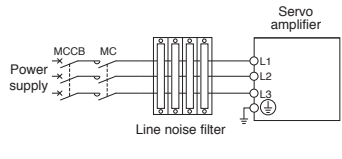
Dimensions [Unit: mm]	Connections
<p>FR-BSF01</p> 	<p>The line noise filters can be mounted on lines of the main circuit power supply (L1, L2, and L3) and of the servo motor power (U, V, and W). Pass each of the wires through the line noise filter equal times in a same direction. For wires of the main circuit power supply, the effect of the filter rises as the number of passes increases, but generally four passes would be appropriate. For the servo motor power, passes must be four times or less. Do not pass the grounding wire through the filter. Otherwise, the effect of the filter is reduced. Wind the wires by passing through the filter to satisfy the required number of passes as shown in Fig.1. If the wires are too thick to wind, use two or more filters to have the required number of passes as shown in Fig.2. Place the line noise filters as close to the servo amplifier as possible for their best performance.</p> <p>Fig. 1</p>  <p>Fig. 2</p> 

## Data Line Filter

C B A

This filter is effective in preventing noise when attached to the pulse output cable of the pulse train output controller or the motor encoder cable.

Example) ESD-SR-250 (manufactured by NEC TOKIN Corporation)  
ZCAT3035-1330 (manufactured by TDK)  
GRFC-13 (manufactured by Kitagawa Industries Co., Ltd.)

## Surge Killer

C B A

Attach surge killers to AC relays and AC valves around the servo amplifier. Attach diodes to DC relays and DC valves.

Example) Surge killer: CR-50500 (manufactured by Okaya Electric Industries Co., Ltd.)  
Diode: A diode with breakdown voltage four or more times greater than the relay drive voltage, and with current capacity two or more times greater than the relay drive current.

EMC Filter

C B A

The following filters are recommended as a filter compliant with the EMC directive for the power supply of the servo amplifier.

Servo amplifier model	EMC filter model (Note 2)	Rated current [A]	Rated voltage [V AC]	Leakage current [mA]	Mass [kg]	Fig.
MR-JE-10C/B/A to 100C/B/A	HF3010A-UN (Note 1)	10	250	5	3.5	A
MR-JE-200C/B/A, 300C/B/A	HF3030A-UN (Note 1)	30	250	5	3.5	B

Notes: 1. Manufactured by Soshin Electric Co., Ltd.  
 A surge protector is separately required to use this EMC filter. Refer to "EMC Installation Guidelines."  
 2. When using the EMC filter, install one EMC filter for each servo amplifier.

	Dimensions [Unit: mm]	Connections
A	<p><b>HF3010A-UN</b></p>	<p>For 3-phase 200 V AC</p> <p>For 1-phase 200 V AC (1 kW or smaller)</p>
B	<p><b>HF3030A-UN</b></p>	<p>For 1-phase 200 V AC (2 kW)</p>

Servo Amplifiers

Servo Motors

Options/Peripheral Equipment

LVS/Wires

Product List

Cautions

## Power Factor Improving AC Reactor (FR-HAL)

This boosts the power factor of servo amplifier and reduces the power supply capacity.

Servo amplifier model	Power factor improving AC reactor model <small>(Note 1)</small>	Fig.
MR-JE-10C/B/A	FR-HAL-0.4K	A
MR-JE-20C/B/A	FR-HAL-0.4K	
MR-JE-40C/B/A	FR-HAL-0.75K	
MR-JE-70C/B/A	FR-HAL-1.5K	
MR-JE-100C/B/A (3-phase power supply input)	FR-HAL-2.2K	B
MR-JE-100C/B/A (1-phase power supply input)	FR-HAL-3.7K	
MR-JE-200C/B/A (3-phase power supply input)	FR-HAL-3.7K	
MR-JE-200C/B/A (1-phase power supply input)	FR-HAL-5.5K	
MR-JE-300C/B/A	FR-HAL-5.5K	

Notes: 1. When using the power factor improving AC reactor, install one reactor for each servo amplifier.

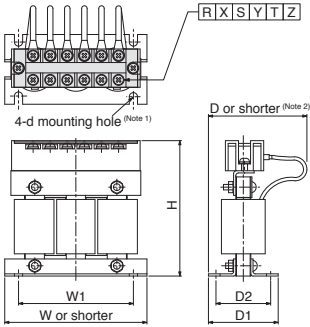
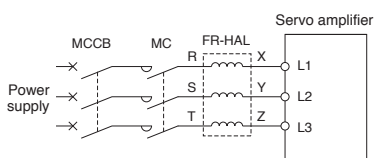
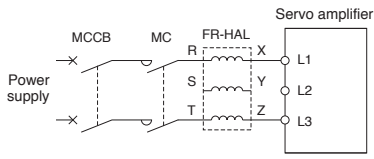
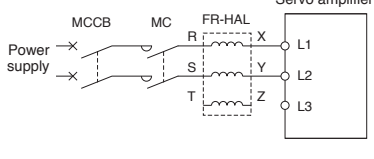
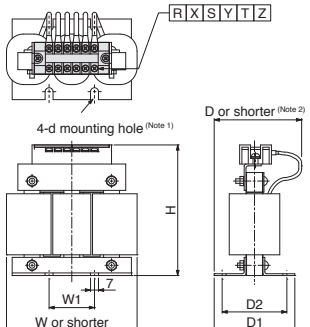
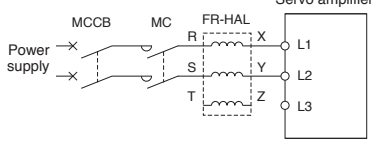
	Dimensions	Connections																																																			
A	 <table border="1" style="margin-top: 10px;"> <thead> <tr> <th rowspan="2">Model</th> <th colspan="7">Variable dimensions [mm]</th> </tr> <tr> <th>W</th> <th>W1</th> <th>H</th> <th>D</th> <th>D1</th> <th>D2</th> <th>d</th> </tr> </thead> <tbody> <tr> <td>FR-HAL-0.4K</td> <td>104±2</td> <td>84</td> <td>99</td> <td>72</td> <td>51</td> <td>40</td> <td>M5</td> </tr> <tr> <td>FR-HAL-0.75K</td> <td>104±2</td> <td>84</td> <td>99</td> <td>74</td> <td>56</td> <td>44</td> <td>M5</td> </tr> <tr> <td>FR-HAL-1.5K</td> <td>104±2</td> <td>84</td> <td>99</td> <td>77</td> <td>61</td> <td>50</td> <td>M5</td> </tr> </tbody> </table> <table border="1" style="margin-top: 10px;"> <thead> <tr> <th>Model</th> <th>Mass [kg]</th> <th>Terminal screw size</th> </tr> </thead> <tbody> <tr> <td>FR-HAL-0.4K</td> <td>0.6</td> <td>M4</td> </tr> <tr> <td>FR-HAL-0.75K</td> <td>0.8</td> <td>M4</td> </tr> <tr> <td>FR-HAL-1.5K</td> <td>1.1</td> <td>M4</td> </tr> </tbody> </table>	Model	Variable dimensions [mm]							W	W1	H	D	D1	D2	d	FR-HAL-0.4K	104±2	84	99	72	51	40	M5	FR-HAL-0.75K	104±2	84	99	74	56	44	M5	FR-HAL-1.5K	104±2	84	99	77	61	50	M5	Model	Mass [kg]	Terminal screw size	FR-HAL-0.4K	0.6	M4	FR-HAL-0.75K	0.8	M4	FR-HAL-1.5K	1.1	M4	<p><b>For 3-phase 200 V AC</b></p>  <p><b>For 1-phase 200 V AC (1 kW or smaller)</b></p>  <p><b>For 1-phase 200 V AC (2 kW)</b></p> 
Model	Variable dimensions [mm]																																																				
	W	W1	H	D	D1	D2	d																																														
FR-HAL-0.4K	104±2	84	99	72	51	40	M5																																														
FR-HAL-0.75K	104±2	84	99	74	56	44	M5																																														
FR-HAL-1.5K	104±2	84	99	77	61	50	M5																																														
Model	Mass [kg]	Terminal screw size																																																			
FR-HAL-0.4K	0.6	M4																																																			
FR-HAL-0.75K	0.8	M4																																																			
FR-HAL-1.5K	1.1	M4																																																			
B	 <table border="1" style="margin-top: 10px;"> <thead> <tr> <th rowspan="2">Model</th> <th colspan="7">Variable dimensions [mm]</th> </tr> <tr> <th>W</th> <th>W1</th> <th>H</th> <th>D</th> <th>D1</th> <th>D2</th> <th>d</th> </tr> </thead> <tbody> <tr> <td>FR-HAL-2.2K</td> <td>115</td> <td>40</td> <td>115</td> <td>77</td> <td>71</td> <td>57</td> <td>M6</td> </tr> <tr> <td>FR-HAL-3.7K</td> <td>115</td> <td>40</td> <td>115</td> <td>83</td> <td>81</td> <td>67</td> <td>M6</td> </tr> <tr> <td>FR-HAL-5.5K</td> <td>115</td> <td>40</td> <td>115</td> <td>83</td> <td>81</td> <td>67</td> <td>M6</td> </tr> </tbody> </table> <table border="1" style="margin-top: 10px;"> <thead> <tr> <th>Model</th> <th>Mass [kg]</th> <th>Terminal screw size</th> </tr> </thead> <tbody> <tr> <td>FR-HAL-2.2K</td> <td>1.5</td> <td>M4</td> </tr> <tr> <td>FR-HAL-3.7K</td> <td>2.2</td> <td>M4</td> </tr> <tr> <td>FR-HAL-5.5K</td> <td>2.3</td> <td>M4</td> </tr> </tbody> </table>	Model	Variable dimensions [mm]							W	W1	H	D	D1	D2	d	FR-HAL-2.2K	115	40	115	77	71	57	M6	FR-HAL-3.7K	115	40	115	83	81	67	M6	FR-HAL-5.5K	115	40	115	83	81	67	M6	Model	Mass [kg]	Terminal screw size	FR-HAL-2.2K	1.5	M4	FR-HAL-3.7K	2.2	M4	FR-HAL-5.5K	2.3	M4	<p><b>For 1-phase 200 V AC (2 kW)</b></p> 
Model	Variable dimensions [mm]																																																				
	W	W1	H	D	D1	D2	d																																														
FR-HAL-2.2K	115	40	115	77	71	57	M6																																														
FR-HAL-3.7K	115	40	115	83	81	67	M6																																														
FR-HAL-5.5K	115	40	115	83	81	67	M6																																														
Model	Mass [kg]	Terminal screw size																																																			
FR-HAL-2.2K	1.5	M4																																																			
FR-HAL-3.7K	2.2	M4																																																			
FR-HAL-5.5K	2.3	M4																																																			

Notes: 1. Use this mounting hole for grounding.

2. This indicates the maximum dimension. The dimension varies depending on the bending degree of the input/output lines.

## Servo Support Software

C B A

## Capacity selection software (MRZJW3-MOTSZ111E)

## Specifications

Item	Description
Types of machine component	Horizontal ball screws, vertical ball screws, rack and pinions, roll feeds, rotating tables, carts, elevators, conveyors, other (direct inertia input) devices
Output of results	Item Servo amplifier, servo motor, regenerative option, moment of inertia of load, load to motor inertia ratio, peak torque, peak torque ratio, effective torque, effective torque ratio, regenerative power, regenerative power ratio
	Printing Prints entered specifications, operation pattern, calculation process, graph of selection process feed speed (or motor speed) and torque, and sizing results.
	Data saving Entered specifications, operation patterns and sizing results are saved with a file name.
Moment of inertia calculation function	Cylinder, square block, variable speed, linear movement, hanging, conical, conical base

## Operating environment

Components	Capacity selection software (MRZJW3-MOTSZ111E) (Note 1)		
Personal computer (Note 2)	OS (Note 3) (English version)	Microsoft® Windows® 10 Education Microsoft® Windows® 10 Enterprise Microsoft® Windows® 10 Pro Microsoft® Windows® 10 Home Microsoft® Windows® 8.1 Enterprise Microsoft® Windows® 8.1 Pro Microsoft® Windows® 8.1 Microsoft® Windows® 8 Enterprise Microsoft® Windows® 8 Pro Microsoft® Windows® 8 Microsoft® Windows® 7 Enterprise Microsoft® Windows® 7 Ultimate Microsoft® Windows® 7 Professional Microsoft® Windows® 7 Home Premium Microsoft® Windows® 7 Starter	Microsoft® Windows Vista® Enterprise Microsoft® Windows Vista® Ultimate Microsoft® Windows Vista® Business Microsoft® Windows Vista® Home Premium Microsoft® Windows Vista® Home Basic Microsoft® Windows® XP Professional Microsoft® Windows® XP Home Edition Microsoft® Windows® 2000 Professional Microsoft® Windows® Millennium Edition Microsoft® Windows® 98 Second Edition Microsoft® Windows® 98
		CPU	Pentium® 133 MHz or more (Windows® 98, Windows® 2000) Pentium® 150 MHz or more (Windows® Millennium Edition) Pentium® 300 MHz or more (Windows® XP) 1 GHz or more 32-bit (x86) processor (Windows Vista®) 1 GHz or more 32-bit (x86) or 64-bit (x64) processor (Windows® 7, Windows® 8, Windows® 8.1, Windows® 10)
		Memory	24 MB or more (Windows® 98) 32 MB or more (Windows® Millennium Edition, Windows® 2000) 128 MB or more (Windows® XP) 1 GB or more (Windows Vista®, Windows® 7, Windows® 8, Windows® 8.1, Windows® 10)
		Free hard disk space	40 MB or more
Browser	Windows® Internet Explorer® 4.0 or later		
Monitor	Resolution 800 × 600 or more, 16-bit high color, Compatible with above personal computers.		
Keyboard	Compatible with above personal computers.		
Mouse	Compatible with above personal computers.		
Printer	Compatible with above personal computers.		

Notes: 1. Software version C6 or later is compatible with MR-JE-A. Software version D2 or later is compatible with MR-JE-B. Software version D6 or later is compatible with MR-JE-C.

2. This software may not run correctly, depending on a personal computer.

3. For 64-bit operating system, this software is compatible with Windows® 7 or later.

## Servo Support Software

MELSOFT

### MR Configurator2 (SW1DNC-MRC2-E)



MR Configurator2 can be obtained by either of the following:

- Purchase MR Configurator2 alone.
- Purchase MT Works2: MR Configurator2 is included in MT Works2 with software version 1.34L or later.
- Download MR Configurator2: If you have MELSOFT iQ Works, GX Works3, GX Works2, MT Works2, EM Software Development Kit, or CW Configurator, MR Configurator2 is available for free download.

### Specifications

Item	Description
Project	New/Open/Close/Save/Save As/Delete Project, System Setting, Print
Parameter	Parameter Setting, Axis Name Setting <sup>(Note 2)</sup> , Parameter Converter <sup>(Note 2)</sup>
Positioning data	Point Table <sup>(Note 3)</sup> , Program <sup>(Note 2)</sup> , Indirect Addressing <sup>(Note 2)</sup> , Cam Data <sup>(Note 2)</sup>
Monitor	Display All, I/O Monitor, Graph, ABS Data Display <sup>(Note 1)</sup>
Diagnosis	Alarm Display, Alarm Onset Data, Drive Recorder, No Motor Rotation, System Configuration, Life Diagnosis, Machine Diagnosis
Test operation	JOG Operation, Positioning Operation, Motor-Less Operation, DO Forced Output, Program Operation, Single-step Feed <sup>(Note 2)</sup> , Test Operation Information
Adjustment	One-touch Tuning, Tuning, Machine Analyzer
Others	Servo Assistant, Update Parameter Setting Range, Machine Unit Conversion Setting <sup>(Note 4)</sup> , Switch Display Language, Help

Notes: 1. Available only with MR-JE-\_C and MR-JE-\_B.

2. Available only with MR-JE-\_A.

3. Available only with MR-JE-\_C with software version A4 or later and MR-JE-\_A. When using MR-JE-\_C, use MR Configurator2 with software version 1.72A or later.

4. Available only with MR-JE-\_B.

### Operating environment

Components		MR Configurator2 <sup>(Note 3)</sup>	
Personal computer <sup>(Note 1)</sup>	OS <sup>(Note 2)</sup>	Microsoft® Windows® 10 Education	Microsoft® Windows® 7 Enterprise
		Microsoft® Windows® 10 Enterprise	Microsoft® Windows® 7 Ultimate
		Microsoft® Windows® 10 Pro	Microsoft® Windows® 7 Professional
		Microsoft® Windows® 10 Home	Microsoft® Windows® 7 Home Premium
		Microsoft® Windows® 8.1 Enterprise	Microsoft® Windows® 7 Starter
Microsoft® Windows® 8.1 Pro		Microsoft® Windows Vista® Enterprise	
Microsoft® Windows® 8.1		Microsoft® Windows Vista® Ultimate	
Microsoft® Windows® 8 Enterprise		Microsoft® Windows Vista® Business	
Microsoft® Windows® 8 Pro		Microsoft® Windows Vista® Home Premium	
Microsoft® Windows® 8		Microsoft® Windows Vista® Home Basic	
		Microsoft® Windows® XP Professional, Service Pack 3	Microsoft® Windows® XP Home Edition, Service Pack 3
	CPU (recommended)	Desktop PC: Intel® Celeron® processor 2.8 GHz or more Laptop PC: Intel® Pentium® M processor 1.7 GHz or more	
	Memory (recommended)	512 MB or more (32-bit OS), 1 GB or more (64-bit OS)	
	Free hard disk space	1 GB or more	
	Browser	Windows® Internet Explorer® 4.0 or later	
	Monitor	Resolution 1024 x 768 or more, 16-bit high color, Compatible with above personal computers.	
	Keyboard	Compatible with above personal computers.	
	Mouse	Compatible with above personal computers.	
	Printer	Compatible with above personal computers.	
	USB cable	MR-J3USBCBL3M	

Notes: 1. This software may not run correctly, depending on a personal computer being used.

2. For 64-bit operating system, this software is supported by Windows® 7 or later.

3. Software version 1.19V or later is compatible with MR-JE-A, 1.34L or later with MR-JE-B, and 1.63R or later with MR-JE-C.



# 4 Low-Voltage Switchgear/ Wires

Features of Low-Voltage Switchgear .....	4-1
Wires, Molded-Case Circuit Breakers and Magnetic Contactors .....	4-4
Selection Example in HIV Wires for Servo Motors .....	4-4
Motor Circuit Breakers.....	4-5

# Low-Voltage Switchgear/Wires

## Mitsubishi Electric Molded Case Circuit Breakers and Earth Leakage Circuit Breakers WS-V Series

"WS-V Series" is the new circuit breakers that have a lot of superior aspects such as higher breaking capacity, design for easy use, standardization of accessory parts, and complies with the global standards.

### Features

**Technologies based on long years of experience are brought together to achieve improved performance**

The new circuit breaking technology "Expanded ISTAC" has improved the current-limiting performance and upgraded the overall breaking capacity. Expansion of the conductor under the stator shortens the contact parting time of the mover as compared to the conventional ISTAC structure. The current-limiting performance has been improved remarkably. (The maximum peak current value has been reduced by approx. 10%.)

### Compact design for ease of use

The thermal adjustable circuit breakers and electronic circuit breakers are smaller.

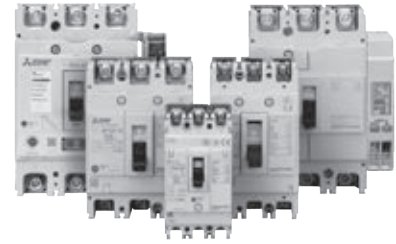

### New circuit breaking technology (Expanded ISTAC)

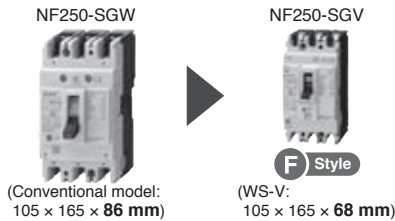
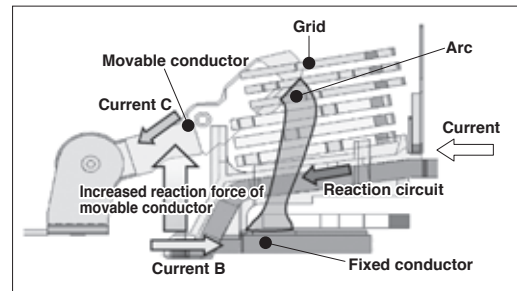

**Volume ratio 79%**  
(Compared with our conventional models)

**Types of internal accessories are reduced from 3 types to 1 type**  
Standardization of internal accessories contributes to a reduction of stock and delivery time.

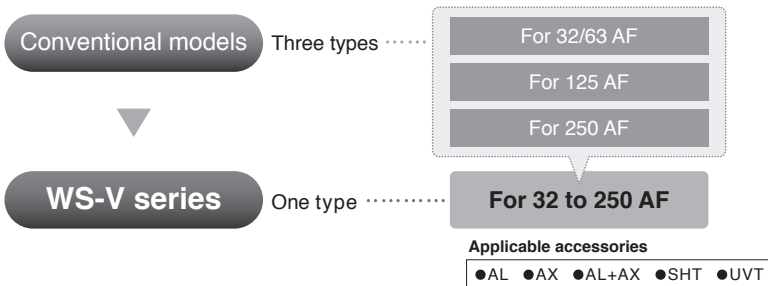

### Breaking capacity comparison with a conventional model

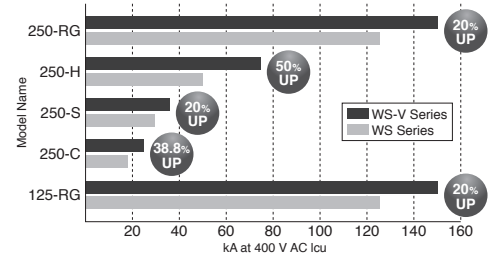

### Lineup of UL 489 listed circuit breakers with 54 mm width "Small Fit" (F Style)

The compact breakers contribute to a size reduction of machines, and IEC 35 mm rail mounting is standard.

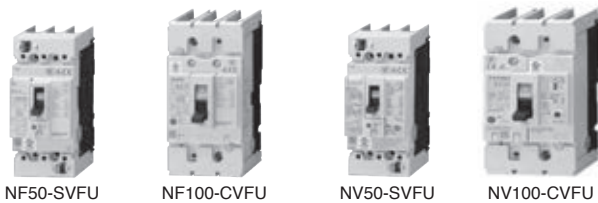

For security and standard compliance of machines, F-type and V-type operating handles are available for breakers with 54 mm width.

### Lineup of UL 489 listed circuit breakers for 480 V AC "High Performance"

The breaking capacity has been improved to satisfy the request for SCCR upgrading.

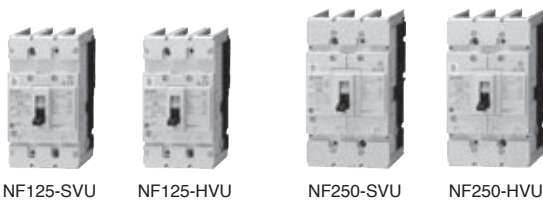

Breaking capacity of UL 489 listed circuit breakers for 480 V AC (UL 489)

- NF125-SVU/NV125-SVU: 30 kA
- NF125-HVU/NV125-HVU: 50 kA
- NF250-SVU/NV250-SVU: 35 kA
- NF250-HVU/NV250-HVU: 50 kA

### Mitsubishi Electric Magnetic Motor Starters and Magnetic Contactors MS-T Series

MS-T series is released!

The MS-T series is smaller than ever, enabling more compact control panel. The MS-T series is suitable for MELSERVO-JE series as well as other Mitsubishi Electric FA equipment. In addition, the MS-T complies with a variety of global standards, supporting the global use.



S-T10

#### Features

##### Down-sizing

**Just 36 mm wide for 10 A-frame type!**

General-purpose magnetic contactor with smallest width\* in the industry.

The width of MS-T series is reduced by 32% as compared to the prior MS-N series, enabling a more compact panel.

\*Based on Mitsubishi Electric research as of March 2016 in the general-purpose magnetic contactor industry for 10 A-frame class.

[Unit: mm]

Frame size		11 A	13 A		20 A	25 A
MS-N series	Front view					
		S-N10	S-N11 (Auxiliary 1-pole)	S-N12 (Auxiliary 2-pole)	S-N20	S-N25
New MS-T series	Front view					
		S-T10	S-T12 (Auxiliary 2-pole)	S-T20	S-T25	

Frame size		35 A	50 A	65 A	80 A	100 A
MS-N series	Front view					
		S-N35	S-N50	S-N65	S-N80	S-N95
New MS-T series	Front view					
		S-T35	S-T50	S-T65	S-T80	S-T100

#### Standardization

##### Covers provided as standard equipment (Target frame: 10 AF to 50 AF)

Terminal cover and auxiliary contact unit covers are provided as standard equipment. Not only ensuring your safety, but also saving you time and cost of selecting and purchasing the covers separately.

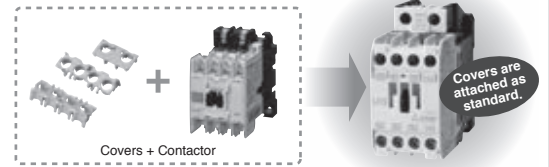

##### Wide-ranged operation coil rating (Target frame: 10 AF to 35 AF)

The prior series had 13 types of the operation coil rating. Owing to the wide-ranged operation coil rating, the number of the rating types for the MS-T series is reduced to seven types, making it easier to select as compared to the prior model.

Consolidating the number of the produced coils type allows not just the reduction of customer storage, but also shortening of delivery time.

Coil designation	Rated voltage [V]		Coil designation	Rated voltage [V]
	50 Hz	60 Hz		50 Hz/60 Hz
AC24 V	24	24	AC24 V	24
AC48 V	48 to 50	48 to 50	AC48 V	48 to 50
AC100 V	100	100 to 110	AC100 V	100 to 127
AC120 V	110 to 120	115 to 120	AC200 V	200 to 240
AC127 V	125 to 127	127	AC300 V	260 to 300
AC200 V	200	200 to 220	AC400 V	380 to 440
AC220 V	208 to 220	220	AC500 V	460 to 550
AC230 V	220 to 240	230 to 240		
AC260 V	240 to 260	260 to 280		
AC380 V	346 to 380	380		
AC400 V	380 to 415	400 to 440		
AC440 V	415 to 440	460 to 480		
AC500 V	500	500 to 550		

\* The conventional seven types are available for the 50 A and larger frames.

Servo Amplifiers

Servo Motors

Options/Peripheral Equipment

LVSWires

Product List

Cautions

# Low-Voltage Switchgear/Wires

**Capable of direct drive with transistor output of programmable controller, etc. (Target frame: 13 AF to 32 AF DC-operated models)**

The adopted high-efficiency polarized electromagnet greatly reduces the coil power consumption, and enables all models to be directly driven with a DC 24 V, 0.1 A rating transistor output. (DC 24 V coil)

	Conventional Model	New Model	Lowering Rate
13 A Frame (Coil: DC 12/24 V)*	7 W	2.2 W	69%
20 A Frame (Coil: DC 12/24 V)	9 W	2.2 W	76%
32 A Frame (Coil: DC 12/24 V)	-	2.2 W	-

\*DC 48 V to DC 220 V: 3.3 W

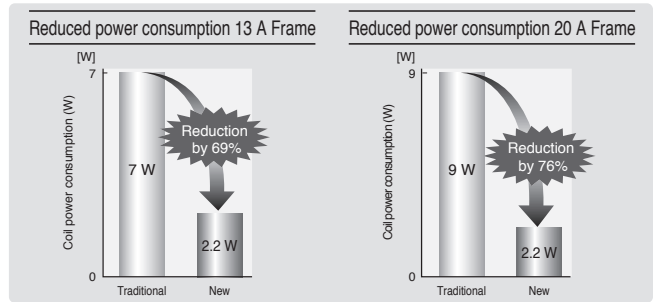

## Safety & Quality

**Terminal cover with finger protection function (Target frame: 10 AF to 50 AF)**

The integrated terminal covers offer various benefits not to mention added protection against electric shock through secure finger protection. This is available not only on Magnetic Contactors but also on Thermal Overload Relays, Contactor Relays and Auxiliary Contact Units.

MS-T Series complies with DIN EN 50274/VDE 0660 Teil 514 for "Finger safe (prevention of finger contact)."

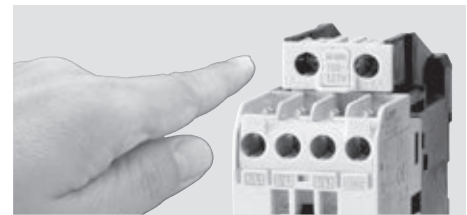

**A light touch (Target frame: All S-T Series)**

The MS-T Series' auxiliary contacts can operate with load as light as 20 V 3 mA making it suitable for direct control/operation from a programmable controller output.



## Smart wiring

**Smart design means Smart wiring (Target frame: 10 AF to 50 AF)**

The integrated terminal covers have an additional benefit in that they act as a guide to improve wiring efficiency but also retain the terminal screw in place: no mislaying the screw, no dropping it or having trouble reinserting it into the terminal block just fast efficient wiring. Fast wiring terminals (model name with suffix "BC") are also available to further improve wiring efficiency, workability and hence productivity.

**Image of Fast wiring terminals (BC type)**

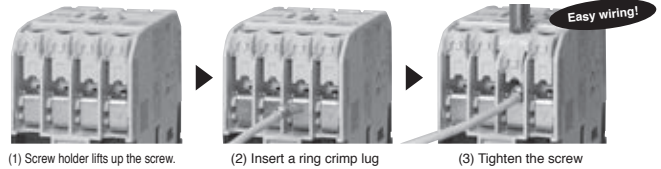

## Global Standard

**Complies with main International Standards (Target frame: All S-T Series)**

In addition to compliance with the main International Standards including IEC, JIS, UL, CE, and CCC, we plan to acquire compliance with Shipping Standards and other International Standards.

We hope to contribute to your business expansions overseas.

Standard	Applicable Standard				Safety Standard
	International	Japan	Europe	China	U.S.A./ Canada
	IEC*1	JIS	EN EC Directive	Certification Body	GB
CE			TÜV Rheinland	CCC	

\*1. Also compliant with the requirements for mirror contacts comply with IEC60947-4-1 Annex F.

**Wires, Molded-Case Circuit Breakers and Magnetic Contactors**

**C B A**

The following are examples of wire sizes when 600 V grade heat-resistant polyvinyl chloride insulated wires (HIV wires) are used. The wire size for U, V, W, and  $\ominus$  varies depending on the servo motor. Refer to "Selection Example in HIV Wires for Servo Motors" in this catalog for details on wires for each servo motor.

Servo amplifier model	Molded-case circuit breaker <small>(Note 4, 5, 6)</small>	Magnetic contactor <small>(Note 2, 5)</small>	Wire size [mm <sup>2</sup> ] <small>(Note 4)</small>		
			L1, L2, L3, $\ominus$	P+, C	U, V, W, $\ominus$
MR-JE-10C/B/A	30 A frame 5 A (30 A frame 5 A)	S-T10	2 (AWG 14)	2 (AWG 14) <small>(Note 1)</small>	AWG 18 to 14 <small>(Note 3)</small>
MR-JE-20C/B/A	30 A frame 5 A (30 A frame 5 A)	S-T10			
MR-JE-40C/B/A	30 A frame 10 A (30 A frame 5 A)	S-T10			
MR-JE-70C/B/A	30 A frame 15 A (30 A frame 10 A)	S-T10			
MR-JE-100C/B/A (3-phase power supply input)	30 A frame 15 A (30 A frame 10 A)	S-T10			
MR-JE-100C/B/A (1-phase power supply input)	30 A frame 15 A (30 A frame 15 A)	S-T10			
MR-JE-200C/B/A (3-phase power supply input)	30 A frame 20 A (30 A frame 20 A)	S-T21	3.5 (AWG 12)		AWG 16 to 10 <small>(Note 3)</small>
MR-JE-200C/B/A (1-phase power supply input)	30 A frame 20 A (30 A frame 20 A)	S-T21			
MR-JE-300C/B/A	30 A frame 30 A (30 A frame 30 A)	S-T21			

- Notes: 1. Keep the wire length to the regenerative option within 5 m.  
 2. Be sure to use a magnetic contactor with an operation delay time of 80 ms or less. The operation delay time is the time interval from current being applied to the coil until closure of contacts.  
 3. The wire size shows applicable size for the servo amplifier connector.  
 4. When complying with IEC/EN/UL/CSA standard, refer to "MELSERVO-JE Instructions and Cautions for Safe Use of AC Servos" enclosed with the servo amplifier. When using a power improving reactor, use a molded-case circuit breaker listed in the brackets.  
 5. Install one molded-case circuit breaker and one magnetic contactor for each servo amplifier.  
 6. Use a molded-case circuit breaker having the operation characteristics equal to or higher than Mitsubishi Electric general-purpose products.

**Selection Example in HIV Wires for Servo Motors**

**C B A**

The following are examples of wire sizes when 600 V grade heat-resistant polyvinyl chloride insulated wires (HIV wires) with a length of 30 m are used. Refer to "HG-KN HG-SN Servo Motor Instruction Manual" when using cab-tire cables for supplying power (U, V, and W) to HG-SN series.

Servo motor model	Wire size [mm <sup>2</sup> ]	
	For power and grounding (U, V, W, $\ominus$ ) (general environment)	For electromagnetic brake (B1, B2)
HG-KN13(B)J, 23(B)J, 43(B)J, 73(B)J	0.75 (AWG 18) <small>(Note 1, 2, 3)</small>	0.5 (AWG 20) <small>(Note 4, 6)</small>
HG-SN52(B)J, 102(B)J	1.25 (AWG 16) <small>(Note 5)</small>	1.25 (AWG 16)
HG-SN152(B)J, 202(B)J	2 (AWG 14)	
HG-SN302(B)J	3.5 (AWG 12)	

- Notes: 1. Use a fluorine resin wire of 0.75 mm<sup>2</sup> (AWG 18) for wiring to the servo motor power connector.  
 2. This size is applicable for wiring length of 10 m or shorter. For over 10 m, use MR-PWS2CBL03M-A\_-L and extend it with HIV wire of 1.25 mm<sup>2</sup> (AWG 16).  
 3. When complying with UL/CSA standard, extend the wire using MR-PWS2CBL03M-A\_-L and HIV wire of 2 mm<sup>2</sup> (AWG 14).  
 4. Use a fluorine resin wire of 0.5 mm<sup>2</sup> (AWG 20) when connecting to servo motor electromagnetic brake connector.  
 5. When complying with UL/CSA standard, use 2 mm<sup>2</sup> (AWG 14). Refer to "HG-KN HG-SN Servo Motor Instruction Manual" for details.  
 6. This size is applicable for wiring length of 10 m or shorter. For over 10 m, extend the wire with HIV wire of 1.25 mm<sup>2</sup> (AWG 16).

Servo Amplifiers  
 Servo Motors  
 Options/Peripheral Equipment  
 LVSM/Wires  
 Product List  
 Cautions

# Low-Voltage Switchgear/Wires

## Motor Circuit Breakers

**C** **B** **A**

A motor circuit breaker is a device integrating the functions of a molded-case circuit breaker and a thermal overload relay, and can be used instead of a molded-case circuit breaker.

Servo amplifier	Rated input voltage AC [V]	Input phase <sup>(Note 2)</sup>	Motor circuit breaker			SCCR [kA] <sup>(Note 1)</sup>
			Model	Rated voltage AC [V]	Rated current [A] (Heater design)	
MR-JE-10C/B/A	200 to 240	3-phase	MMP-T32	240	1.6	50
MR-JE-20C/B/A					2.5	
MR-JE-40C/B/A					4	
MR-JE-70C/B/A					6.3	
MR-JE-100C/B/A					8	
MR-JE-200C/B/A					18	
MR-JE-350C/B/A					25	25

Notes: 1. The value is applicable when the motor circuit breaker is combined with the servo amplifier.

2. 1-phase power input is not supported.

MEMO

Servo Amplifiers

Servo Motors

Options/Peripheral  
Equipment

LVSWires

Product List

Cautions

# Product List

## Servo amplifiers

Item	Model	Rated output	Power supply input
MR-JE-C	MR-JE-10C	0.1 kW	3-phase or 1-phase 200 V AC to 240 V AC
	MR-JE-20C	0.2 kW	3-phase or 1-phase 200 V AC to 240 V AC
	MR-JE-40C	0.4 kW	3-phase or 1-phase 200 V AC to 240 V AC
	MR-JE-70C	0.75 kW	3-phase or 1-phase 200 V AC to 240 V AC
	MR-JE-100C	1 kW	3-phase or 1-phase 200 V AC to 240 V AC
	MR-JE-200C	2 kW	3-phase or 1-phase 200 V AC to 240 V AC
MR-JE-B	MR-JE-300C	3 kW	3-phase 200 V AC to 240 V AC
	MR-JE-10B	0.1 kW	3-phase or 1-phase 200 V AC to 240 V AC
	MR-JE-20B	0.2 kW	3-phase or 1-phase 200 V AC to 240 V AC
	MR-JE-40B	0.4 kW	3-phase or 1-phase 200 V AC to 240 V AC
	MR-JE-70B	0.75 kW	3-phase or 1-phase 200 V AC to 240 V AC
	MR-JE-100B	1 kW	3-phase or 1-phase 200 V AC to 240 V AC
MR-JE-A	MR-JE-200B	2 kW	3-phase or 1-phase 200 V AC to 240 V AC
	MR-JE-300B	3 kW	3-phase 200 V AC to 240 V AC
	MR-JE-10A	0.1 kW	3-phase or 1-phase 200 V AC to 240 V AC
	MR-JE-20A	0.2 kW	3-phase or 1-phase 200 V AC to 240 V AC
	MR-JE-40A	0.4 kW	3-phase or 1-phase 200 V AC to 240 V AC
	MR-JE-70A	0.75 kW	3-phase or 1-phase 200 V AC to 240 V AC
MR-JE-A	MR-JE-100A	1 kW	3-phase or 1-phase 200 V AC to 240 V AC
	MR-JE-200A	2 kW	3-phase or 1-phase 200 V AC to 240 V AC
	MR-JE-300A	3 kW	3-phase 200 V AC to 240 V AC

## Servo motors

Item	Model	Rated output	Rated speed
HG-KN series Without electromagnetic brake With oil seal	HG-KN13J	100 W	3000 r/min
	HG-KN23J	200 W	3000 r/min
	HG-KN43J	400 W	3000 r/min
	HG-KN73J	750 W	3000 r/min
HG-KN series Without electromagnetic brake Without oil seal	HG-KN13	100 W	3000 r/min
	HG-KN23	200 W	3000 r/min
	HG-KN43	400 W	3000 r/min
HG-KN series With electromagnetic brake With oil seal	HG-KN13BJ	100 W	3000 r/min
	HG-KN23BJ	200 W	3000 r/min
	HG-KN43BJ	400 W	3000 r/min
	HG-KN73BJ	750 W	3000 r/min
HG-KN series With electromagnetic brake Without oil seal	HG-KN13B	100 W	3000 r/min
	HG-KN23B	200 W	3000 r/min
	HG-KN43B	400 W	3000 r/min
HG-SN series Without electromagnetic brake With oil seal	HG-SN52J	0.5 kW	2000 r/min
	HG-SN102J	1.0 kW	2000 r/min
	HG-SN152J	1.5 kW	2000 r/min
	HG-SN202J	2.0 kW	2000 r/min
	HG-SN302J	3.0 kW	2000 r/min
HG-SN series With electromagnetic brake With oil seal	HG-SN52BJ	0.5 kW	2000 r/min
	HG-SN102BJ	1.0 kW	2000 r/min
	HG-SN152BJ	1.5 kW	2000 r/min
	HG-SN202BJ	2.0 kW	2000 r/min
	HG-SN302BJ	3.0 kW	2000 r/min



Encoder cables/Junction cables

Item	Model	Length	Bending life	IP rating	Application
Encoder cable (load-side lead)	MR-J3ENCBL2M-A1-H	2 m	Long bending life	IP65	For HG-KN (direct connection type)
	MR-J3ENCBL5M-A1-H	5 m	Long bending life	IP65	For HG-KN (direct connection type)
	MR-J3ENCBL10M-A1-H	10 m	Long bending life	IP65	For HG-KN (direct connection type)
	MR-J3ENCBL2M-A1-L	2 m	Standard	IP65	For HG-KN (direct connection type)
	MR-J3ENCBL5M-A1-L	5 m	Standard	IP65	For HG-KN (direct connection type)
Encoder cable (opposite to load-side lead)	MR-J3ENCBL2M-A2-H	2 m	Long bending life	IP65	For HG-KN (direct connection type)
	MR-J3ENCBL5M-A2-H	5 m	Long bending life	IP65	For HG-KN (direct connection type)
	MR-J3ENCBL10M-A2-H	10 m	Long bending life	IP65	For HG-KN (direct connection type)
	MR-J3ENCBL2M-A2-L	2 m	Standard	IP65	For HG-KN (direct connection type)
	MR-J3ENCBL5M-A2-L	5 m	Standard	IP65	For HG-KN (direct connection type)
Encoder cable (load-side lead)	MR-J3JCBL03M-A1-L	0.3 m	Standard	IP20	For HG-KN (junction type) <sup>(Note 1)</sup>
Encoder cable (opposite to load-side lead)	MR-J3JCBL03M-A2-L	0.3 m	Standard	IP20	For HG-KN (junction type) <sup>(Note 1)</sup>
Encoder cable	MR-EKCBL20M-H	20 m	Long bending life	IP20	For HG-KN (junction type) <sup>(Note 2)</sup>
	MR-EKCBL30M-H	30 m	Long bending life	IP20	For HG-KN (junction type) <sup>(Note 2)</sup>
	MR-EKCBL40M-H	40 m	Long bending life	IP20	For HG-KN (junction type) <sup>(Note 2)</sup>
	MR-EKCBL50M-H	50 m	Long bending life	IP20	For HG-KN (junction type) <sup>(Note 2)</sup>
	MR-EKCBL20M-L	20 m	Standard	IP20	For HG-KN (junction type) <sup>(Note 2)</sup>
Encoder cable (load-side lead)	MR-J3JSCBL03M-A1-L	0.3 m	Standard	IP65	For HG-KN (junction type) <sup>(Note 3)</sup>
Encoder cable (opposite to load-side lead)	MR-J3JSCBL03M-A2-L	0.3 m	Standard	IP65	For HG-KN (junction type) <sup>(Note 3)</sup>
Encoder cable	MR-J3ENSCL2M-H	2 m	Long bending life	IP67	For HG-KN (junction type) <sup>(Note 4)</sup> , For HG-SN (direct connection type)
	MR-J3ENSCL5M-H	5 m	Long bending life	IP67	
	MR-J3ENSCL10M-H	10 m	Long bending life	IP67	
	MR-J3ENSCL20M-H	20 m	Long bending life	IP67	
	MR-J3ENSCL30M-H	30 m	Long bending life	IP67	
	MR-J3ENSCL40M-H	40 m	Long bending life	IP67	For HG-KN (junction type) <sup>(Note 4)</sup> , For HG-SN (direct connection type)
	MR-J3ENSCL50M-H	50 m	Long bending life	IP67	
	MR-J3ENSCL2M-L	2 m	Standard	IP67	
	MR-J3ENSCL5M-L	5 m	Standard	IP67	
	MR-J3ENSCL10M-L	10 m	Standard	IP67	
	MR-J3ENSCL20M-L	20 m	Standard	IP67	
MR-J3ENSCL30M-L	30 m	Standard	IP67		

Encoder connector sets/Junction connector sets

Item	Model	Description	IP rating	Application
Encoder connector set	MR-ECNM	Junction connector × 1 Servo amplifier connector × 1	IP20	For HG-KN (junction type) <sup>(Note 2)</sup>
Encoder connector set (one-touch connection type)	MR-J3SCNS	Straight type Junction connector or encoder connector × 1 Servo amplifier connector × 1	IP67	For HG-KN (junction type) <sup>(Note 4)</sup> , For HG-SN (direct connection type)
Encoder connector set (screw type)	MR-ENCNS2	Straight type Encoder connector × 1 Servo amplifier connector × 1	IP67	For HG-SN
Encoder connector set (one-touch connection type)	MR-J3SCNSA	Angle type Encoder connector × 1 Servo amplifier connector × 1	IP67	For HG-SN
Encoder connector set (screw type)	MR-ENCNS2A	Angle type Encoder connector × 1 Servo amplifier connector × 1	IP67	For HG-SN

Notes: 1. Use this in combination with MR-EKCBL\_M-H, MR-EKCBL\_M-L, or MR-ECNM.

2. Use this in combination with MR-J3JCBL03M-A1-L or MR-J3JCBL03M-A2-L.

3. Use this in combination with MR-J3ENSCL\_M-H, MR-J3ENSCL\_M-L, or MR-J3SCNS.

4. Use this in combination with MR-J3JSCBL03M-A1-L or MR-J3JSCBL03M-A2-L when using for HG-KN series.

## Product List

### Servo motor power cables

Item	Model	Length	Bending life	IP rating	Application
Servo motor power cable (load-side lead, lead-out)	MR-PWS1CBL2M-A1-H	2 m	Long bending life	IP65	For HG-KN (direct connection type)
	MR-PWS1CBL5M-A1-H	5 m	Long bending life	IP65	For HG-KN (direct connection type)
	MR-PWS1CBL10M-A1-H	10 m	Long bending life	IP65	For HG-KN (direct connection type)
	MR-PWS1CBL2M-A1-L	2 m	Standard	IP65	For HG-KN (direct connection type)
	MR-PWS1CBL5M-A1-L	5 m	Standard	IP65	For HG-KN (direct connection type)
Servo motor power cable (opposite to load-side lead, lead-out)	MR-PWS1CBL2M-A2-H	2 m	Long bending life	IP65	For HG-KN (direct connection type)
	MR-PWS1CBL5M-A2-H	5 m	Long bending life	IP65	For HG-KN (direct connection type)
	MR-PWS1CBL10M-A2-H	10 m	Long bending life	IP65	For HG-KN (direct connection type)
	MR-PWS1CBL2M-A2-L	2 m	Standard	IP65	For HG-KN (direct connection type)
	MR-PWS1CBL5M-A2-L	5 m	Standard	IP65	For HG-KN (direct connection type)
Servo motor power cable (load-side lead, lead-out)	MR-PWS2CBL03M-A1-L	0.3 m	Standard	IP55	For HG-KN (junction type)
Servo motor power cable (opposite to load-side lead, lead-out)	MR-PWS2CBL03M-A2-L	0.3 m	Standard	IP55	For HG-KN (junction type)

### Servo motor power connector sets

Item	Model	Description	IP rating	Application
Servo motor power connector set EN compliant	MR-PWCNS4	Straight type Power connector × 1	IP67	For HG-SN52J, 102J, 152J
	MR-PWCNS5	Straight type Power connector × 1	IP67	For HG-SN202J, 302J

### Electromagnetic brake cables

Item	Model	Length	Bending life	IP rating	Application
Electromagnetic brake cable (load-side lead, lead-out)	MR-BKS1CBL2M-A1-H	2 m	Long bending life	IP65	For HG-KN (direct connection type)
	MR-BKS1CBL5M-A1-H	5 m	Long bending life	IP65	For HG-KN (direct connection type)
	MR-BKS1CBL10M-A1-H	10 m	Long bending life	IP65	For HG-KN (direct connection type)
	MR-BKS1CBL2M-A1-L	2 m	Standard	IP65	For HG-KN (direct connection type)
	MR-BKS1CBL5M-A1-L	5 m	Standard	IP65	For HG-KN (direct connection type)
	MR-BKS1CBL10M-A1-L	10 m	Standard	IP65	For HG-KN (direct connection type)
Electromagnetic brake cable (opposite to load-side lead, lead-out)	MR-BKS1CBL2M-A2-H	2 m	Long bending life	IP65	For HG-KN (direct connection type)
	MR-BKS1CBL5M-A2-H	5 m	Long bending life	IP65	For HG-KN (direct connection type)
	MR-BKS1CBL10M-A2-H	10 m	Long bending life	IP65	For HG-KN (direct connection type)
	MR-BKS1CBL2M-A2-L	2 m	Standard	IP65	For HG-KN (direct connection type)
	MR-BKS1CBL5M-A2-L	5 m	Standard	IP65	For HG-KN (direct connection type)
	MR-BKS1CBL10M-A2-L	10 m	Standard	IP65	For HG-KN (direct connection type)
Electromagnetic brake cable (load-side lead, lead-out)	MR-BKS2CBL03M-A1-L	0.3 m	Standard	IP55	For HG-KN (junction type)
Electromagnetic brake cable (opposite to load-side lead, lead-out)	MR-BKS2CBL03M-A2-L	0.3 m	Standard	IP55	For HG-KN (junction type)

### Electromagnetic brake connector sets

Item	Model	Description	IP rating	Application
Electromagnetic brake connector set (one-touch connection type)	MR-BKCNS1	Straight type Electromagnetic brake connector × 1	IP67	For HG-SN
Electromagnetic brake connector set (screw type)	MR-BKCNS2	Straight type Electromagnetic brake connector × 1	IP67	For HG-SN
Electromagnetic brake connector set (one-touch connection type)	MR-BKCNS1A	Angle type Electromagnetic brake connector × 1	IP67	For HG-SN
Electromagnetic brake connector set (screw type)	MR-BKCNS2A	Angle type Electromagnetic brake connector × 1	IP67	For HG-SN

SSCNET III cables/SSCNET III connector set

Item	Model	Length	Bending life	IP rating	Application
SSCNET III cable (standard cord inside cabinet) Compatible with SSCNET III(H)	MR-J3BUS015M	0.15 m	Standard	-	For MR-JE-B
	MR-J3BUS03M	0.3 m	Standard	-	For MR-JE-B
	MR-J3BUS05M	0.5 m	Standard	-	For MR-JE-B
	MR-J3BUS1M	1 m	Standard	-	For MR-JE-B
	MR-J3BUS3M	3 m	Standard	-	For MR-JE-B
SSCNET III cable (standard cord outside cabinet) Compatible with SSCNET III(H)	MR-J3BUS5M-A	5 m	Standard	-	For MR-JE-B
	MR-J3BUS10M-A	10 m	Standard	-	For MR-JE-B
	MR-J3BUS20M-A	20 m	Standard	-	For MR-JE-B
SSCNET III cable (long distance cable) Compatible with SSCNET III(H)	MR-J3BUS30M-B	30 m	Long bending life	-	For MR-JE-B
	MR-J3BUS40M-B	40 m	Long bending life	-	For MR-JE-B
	MR-J3BUS50M-B	50 m	Long bending life	-	For MR-JE-B
SSCNET III connector set Compatible with SSCNET III(H)	MR-J3BCN1	-	-	-	For MR-JE-B

Junction terminal blocks/Junction terminal block cables

Item	Model	Length	Application
Junction terminal block (26 pins)	MR-TB26A	-	For MR-JE-C
Junction terminal block cable (For MR-TB26A)	MR-TBNATBL05M	0.5 m	For connecting MR-JE-C and MR-TB26A
	MR-TBNATBL1M	1 m	For connecting MR-JE-C and MR-TB26A
Junction terminal block cable (For PS7DW-20V14B-F)	MR-J2HBUS05M	0.5 m	For connecting MR-JE-B and PS7DW-20V14B-F (Toho Technology Corp.)
	MR-J2HBUS1M	1 m	For connecting MR-JE-B and PS7DW-20V14B-F (Toho Technology Corp.)
	MR-J2HBUS5M	5 m	For connecting MR-JE-B and PS7DW-20V14B-F (Toho Technology Corp.)
Junction terminal block (50 pins)	MR-TB50	-	For MR-JE-A
Junction terminal block cable (for MR-TB50)	MR-J2M-CN1TBL05M	0.5 m	For connecting MR-JE-A and MR-TB50
	MR-J2M-CN1TBL1M	1 m	For connecting MR-JE-A and MR-TB50

Batteries/Battery case/Battery cables

Item	Model	Length	Application
Battery	MR-BAT6V1SET-A	-	For MR-JE-C and MR-JE-B
	MR-BAT6V1	-	For MR-BAT6V1SET-A and MR-BT6VCASE
Battery case	MR-BT6VCASE	-	For MR-JE-C and MR-JE-B
Battery cable	MR-BT6V1CBL03M	0.3 m	For MR-BT6VCASE
	MR-BT6V1CBL1M	1 m	For MR-BT6VCASE
Junction battery cable	MR-BT6V2CBL03M	0.3 m	For MR-BT6VCASE
	MR-BT6V2CBL1M	1 m	For MR-BT6VCASE

Regenerative options

Item	Model	Specifications	Application
Regenerative option	MR-RB032	Permissible regenerative power: 30 W, resistance value: 40 Ω	For MR-JE-10C to MR-JE-100C, MR-JE-10B to MR-JE-100B, and MR-JE-10A to MR-JE-100A
	MR-RB12	Permissible regenerative power: 100 W, resistance value: 40 Ω	For MR-JE-20C to MR-JE-100C, MR-JE-20B to MR-JE-100B, and MR-JE-20A to MR-JE-100A
	MR-RB30	Permissible regenerative power: 300 W, resistance value: 13 Ω	For MR-JE-200C/MR-JE-300C, MR-JE-200B/MR-JE-300B, and MR-JE-200A/MR-JE-300A
	MR-RB32	Permissible regenerative power: 300 W, resistance value: 40 Ω	For MR-JE-70C/MR-JE-100C, MR-JE-70B/MR-JE-100B, and MR-JE-70A/MR-JE-100A
	MR-RB50	Permissible regenerative power: 500 W, resistance value: 13 Ω	For MR-JE-200C/MR-JE-300C, MR-JE-200B/MR-JE-300B, and MR-JE-200A/MR-JE-300A

## Product List

### Peripheral cable

Item	Model	Length	Application
Personal computer communication cable (USB cable)	MR-J3USBCBL3M	3 m	For MR-JE-C, MR-JE-B, and MR-JE-A

### Peripheral connectors

Item	Model	Description	Application
Servo amplifier CNP1 power connector Standard Accessory	MR-JECNP1-01	CNP1 connector × 1, Open tool × 1	For MR-JE-10C to MR-JE-100C, MR-JE-10B to MR-JE-100B, and MR-JE-10A to MR-JE-100A
	MR-JECNP1-02	CNP1 connector × 1, Open tool × 1	For MR-JE-200C/MR-JE-300C, MR-JE-200B/MR-JE-300B, and MR-JE-200A/MR-JE-300A
Servo amplifier CNP2 power connector Standard Accessory	MR-JECNP2-02	CNP2 connector × 1	For MR-JE-200C/MR-JE-300C, MR-JE-200B/MR-JE-300B, and MR-JE-200A/MR-JE-300A
Connector set	MR-CCN1	Servo amplifier connector × 1	For I/O signals of MR-JE-B
	MR-J3CN1	Servo amplifier connector × 1	For I/O signals of MR-JE-A
	MR-J2CMP2	Servo amplifier connector × 1	For I/O signals of MR-JE-C (Qty: 1 pc)
	MR-ECN1	Servo amplifier connector × 1	For I/O signals of MR-JE-C (Qty: 20 pcs)

### Servo Support Software

Item	Model	Application
MR Configurator2	SW1DNC-MRC2-E	Servo setup software for AC servo

MEMO

Servo Amplifiers

Servo Motors

Options/Peripheral  
Equipment

LVS/Wires

Product List

Cautions

# Cautions

## For your safety

- To use the products given in this catalog properly, be sure to read the "Instruction Manual" and the appended document prior to use.

## Cautions for model selection

- Select a servo motor which has the rated torque equal to or higher than the continuous effective torque.
- When unbalanced torque is generated, such as in a vertical lift machine, keep the unbalanced torque of the machine under 70% of the servo motor rated torque.
- Create operation patterns by considering the settling time (ts) to complete positioning.
- Load to motor inertia ratio must be below the recommended ratio. If the ratio is too large, the expected performance may not be achieved, and the dynamic brake may be damaged.

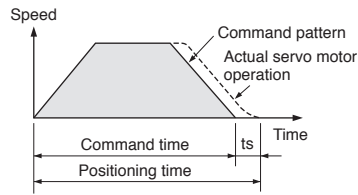

## General safety precautions

### 1. Transportation/installation

- Combinations of the servo motor and the servo amplifier are predetermined. Confirm the models of the servo motor and the servo amplifier to be used before installation.
- Do not drop or apply strong impact on the servo amplifier and the servo motor as they are precision devices. They may be damaged from such stress or shock.
- When fumigants that contain halogen materials such as fluorine, chlorine, bromine, and iodine are used for disinfecting and protecting wooden packaging from insects, they cause malfunction when entering our products. Please take necessary precautions to ensure that remaining materials from fumigant do not enter our products, or treat packaging with methods other than fumigation (heat method). Additionally, disinfect and protect wood from insects before packing products.
- Do not get on or place heavy objects on the servo amplifier or the servo motor. Doing so may result in injury or damage.
- The system must withstand high speeds and high acceleration/ deceleration.
- To enable high-accuracy positioning, ensure the machine rigidity, and keep the machine resonance point at a high level.
- Mount the servo amplifier and the servo motor on nonflammable material. Mounting them directly on or near flammable material may result in fires.
- The regenerative option becomes hot (the temperature rise of 100 °C or higher) with frequent use. Do not install within flammable objects or objects subject to thermal deformation. Make sure that wires do not come into contact with the unit.
- Securely fix the servo motor onto the machine. Insufficient fixing may cause the servo motor to be dislocated during operation.
- Install electrical and mechanical stoppers at the stroke end.
- Mount the servo amplifier vertically on a wall.
- Do not block intake and exhaust areas of the servo amplifier. Doing so may cause the servo amplifier to malfunction.
- When installing multiple servo amplifiers in a row in a sealed cabinet, leave space around the servo amplifiers as described in Servo Amplifier Instruction Manual. To ensure the life and reliability of the servo amplifiers, prevent heat accumulation by keeping space as open as possible toward the top plate.

### 2. Environment

- Use the servo amplifier and the servo motor in the designated environment.
- Avoid installing the servo amplifier and the servo motor in areas with oil mist or dust. When installing in such areas, be sure to enclose the servo amplifier in a sealed cabinet, and protect the servo motor by furnishing a cover or by taking similar measures.
- Do not use in areas where the servo motor may be constantly subject to cutting fluid or lubricant oil, or where dew could condense because of oil mist, overcooling or excessive humidity. Doing so may deteriorate the insulation of the servo motor.

### 3. Grounding

- Securely ground to prevent electric shocks and to stabilize the potential in the control circuit.
- Connect the grounding wire to the cabinet protective earth (PE) terminal via the servo amplifier protective earth (PE) terminal for the servo motor grounding.
- Faults such as a position mismatch may occur if the grounding is insufficient.

### 4. Wiring

- Do not supply power to the output terminals (U, V, and W) of the servo amplifier or the input terminals (U, V, and W) of the servo motor. Doing so damages the servo amplifier and the servo motor.
- Connect the servo motor to the output terminals (U, V, and W) of the servo amplifier.
- Match the phase of the input terminals (U, V, and W) of the servo motor to the output terminals (U, V, and W) of the servo amplifier when connecting them. If they do not match, the servo motor does not operate properly.
- Check the wiring and sequence program thoroughly before switching the power on.
- Carefully select the cable clamping method, and make sure that bending stress and the stress of the cable's own weight are not applied on the cable connection section.
- In an application where the servo motor moves, determine the cable bending radius based on the cable bending life and wire type.

### 5. Initial settings

- For MR-JE-A, select a control mode from position, speed or torque with [Pr. PA01]. Position control mode is set as default. Change the parameter setting value when using the other control modes. For MR-JE-C and MR-JE-B, the control mode is set by the controller.
- When using the regenerative option, change [Pr. PA02]. The regenerative option is disabled as default.

### 6. Operation

- Do not use a product which is damaged or has missing parts. In that case, replace the product.
- Turn on FLS and RLS (Upper/Lower stroke limit), or LSP and LSN (Forward/Reverse rotation stroke end) in position or speed control mode. The servo motor will not start if the signals are off.
- When a magnetic contactor is installed on the primary side of the servo amplifier, do not perform frequent starts and stops with the magnetic contactor. Doing so may damage the servo amplifier.
- When an error occurs, the servo amplifier stops outputting the power with activation of the protective function, and the servo motor stops immediately with the dynamic brake.
- The dynamic brake is a function for emergency stop. Do not use it to stop the servo motor in normal operations.
- As a rough guide, the dynamic brake withstands 1000 times of use when a machine which has load to motor inertia ratio equals to or lower than the recommended ratio stops from the rated speed every 10 minutes.

- When an error occurs, ensure safety by turning the power off, etc., before dealing with the error. Otherwise, it may cause an accident.
- If the protective functions of the servo amplifier activate, turn the power off immediately. Remove the cause before turning the power on again. If operation is continued without removing the cause of the error, the servo motor may malfunction, resulting in injury or damage.
- The servo amplifier, the regenerative resistor, and the servo motor can be very hot during or after operation. Take safety measures such as covering them to prevent your hand and/or parts including cables from coming in contact with them.
- Do not touch the servo amplifier, the regenerative resistor, or the servo motor while the power is on or for a while after the power is turned off. Otherwise, an electric shock may occur. Make sure that the charge lamp is off before wiring or inspection.
- In a maintenance inspection, make sure that the emergency stop circuit operates properly such that an operation can be stopped immediately and a power can be shut off by the emergency stop switch.

#### 7. Others

- Do not touch the servo amplifier or the servo motor with wet hands.
- Do not modify the servo amplifier or the servo motor.

### Cautions for Ethernet cables

- Do not apply excessive tension on the Ethernet cable when cabling.
- Refer to relevant Ethernet cable manual to keep the bending radius within the range of specifications.
- Avoid laying the Ethernet cables and the power cables side by side or do not bundle them together. Separate the Ethernet cables from the power cables.

### Cautions for SSCNET III cables

- Do not apply excessive tension on the SSCNET III cable when cabling.
- The minimum bending radius of the SSCNET III cable is 25 mm for MR-J3BUS\_M and 50 mm for MR-J3BUS\_M-A/-B. If using these cables under the minimum bending radius, performance cannot be guaranteed.
- If the ends of the SSCNET III cable are dirty, the light will be obstructed, causing malfunctions. Keep the ends clean.
- Do not tighten the SSCNET III cable with cable ties, etc.
- Do not look at the light directly when the SSCNET III cable is not connected.

### Cautions for servo motors

- Do not hammer the shaft of the servo motor when installing a pulley or a coupling. Doing so may damage the encoder. When installing the pulley or the coupling to the key shaft servo motor, use the screw hole on the shaft end. Use a pulley extractor when removing the pulley.
- Do not apply a load exceeding the tolerable load onto the servo motor shaft. The shaft may break.
- When the servo motor is mounted with the shaft vertical (shaft up), take measures on the machine side so that oil from the gear box does not get into the servo motor.
- Do not use the 24 V DC interface power supply for the electromagnetic brake. Provide a dedicated power supply to the electromagnetic brake.
- Do not apply the electromagnetic brake when the servo is on. Doing so may cause the servo amplifier overload or shorten the brake life. Apply the electromagnetic brake when the servo is off.
- Torque may drop due to temperature increase of the servo motor. Be sure to use the motor within the specified ambient temperature.

# Cautions

## Warranty

### 1. Warranty period and coverage

We will repair any failure or defect hereinafter referred to as "failure" in our FA equipment hereinafter referred to as the "Product" arisen during warranty period at no charge due to causes for which we are responsible through the distributor from which you purchased the Product or our service provider. However, we will charge the actual cost of dispatching our engineer for an on-site repair work on request by customer in Japan or overseas countries. We are not responsible for any on-site readjustment and/or trial run that may be required after a defective unit is repaired or replaced.

#### [Term]

The term of warranty for Product is twelve (12) months after your purchase or delivery of the Product to a place designated by you or eighteen (18) months from the date of manufacture whichever comes first ("Warranty Period"). Warranty period for repaired Product cannot exceed beyond the original warranty period before any repair work.

#### [Limitations]

- (1) You are requested to conduct an initial failure diagnosis by yourself, as a general rule. It can also be carried out by us or our service company upon your request and the actual cost will be charged. However, it will not be charged if we are responsible for the cause of the failure.
- (2) This limited warranty applies only when the condition, method, environment, etc. of use are in compliance with the terms and conditions and instructions that are set forth in the instruction manual and user manual for the Product and the caution label affixed to the Product.
- (3) Even during the term of warranty, the repair cost will be charged on you in the following cases;
  - (i) a failure caused by your improper storing or handling, carelessness or negligence, etc., and a failure caused by your hardware or software problem
  - (ii) a failure caused by any alteration, etc. to the Product made on your side without our approval
  - (iii) a failure which may be regarded as avoidable, if your equipment in which the Product is incorporated is equipped with a safety device required by applicable laws and has any function or structure considered to be indispensable according to a common sense in the industry
  - (iv) a failure which may be regarded as avoidable if consumable parts designated in the instruction manual, etc. are duly maintained and replaced
  - (v) any replacement of consumable parts (battery, fan, smoothing capacitor, etc.)
  - (vi) a failure caused by external factors such as inevitable accidents, including without limitation fire and abnormal fluctuation of voltage, and acts of God, including without limitation earthquake, lightning and natural disasters
  - (vii) a failure generated by an unforeseeable cause with a scientific technology that was not available at the time of the shipment of the Product from our company
  - (viii) any other failures which we are not responsible for or which you acknowledge we are not responsible for

### 2. Term of warranty after the stop of production

- (1) We may accept the repair at charge for another seven (7) years after the production of the product is discontinued. The announcement of the stop of production for each model can be seen in our Sales and Service, etc.
- (2) Please note that the Product (including its spare parts) cannot be ordered after its stop of production.

### 3. Service in overseas countries

Our regional FA Center in overseas countries will accept the repair work of the Product. However, the terms and conditions of the repair work may differ depending on each FA Center. Please ask your local FA Center for details.

### 4. Exclusion of loss in opportunity and secondary loss from warranty liability

Regardless of the gratis warranty term, Mitsubishi shall not be liable for compensation to:

- (1) Damages caused by any cause found not to be the responsibility of Mitsubishi.
- (2) Loss in opportunity, lost profits incurred to the user by Failures of Mitsubishi products.
- (3) Special damages and secondary damages whether foreseeable or not, compensation for accidents, and compensation for damages to products other than Mitsubishi products.
- (4) Replacement by the user, maintenance of on-site equipment, start-up test run and other tasks.

### 5. Change of Product specifications

Specifications listed in our catalogs, manuals or technical documents may be changed without notice.

### 6. Application and use of the Product

- (1) For the use of our General-Purpose AC Servo, its applications should be those that may not result in a serious damage even if any failure or malfunction occurs in General-Purpose AC Servo, and a backup or fail-safe function should operate on an external system to General-Purpose AC Servo when any failure or malfunction occurs.
- (2) Our General-Purpose AC Servo is designed and manufactured as a general purpose product for use at general industries. Therefore, applications substantially influential on the public interest for such as atomic power plants and other power plants of electric power companies, and also which require a special quality assurance system, including applications for railway companies and government or public offices are not recommended, and we assume no responsibility for any failure caused by these applications when used.

In addition, applications which may be substantially influential to human lives or properties for such as airlines, medical treatments, railway service, incineration and fuel systems, man-operated material handling equipment, entertainment machines, safety machines, etc. are not recommended, and we assume no responsibility for any failure caused by these applications when used.

We will review the acceptability of the abovementioned applications, if you agree not to require a specific quality for a specific application. Please contact us for consultation.



# Global FA Centers

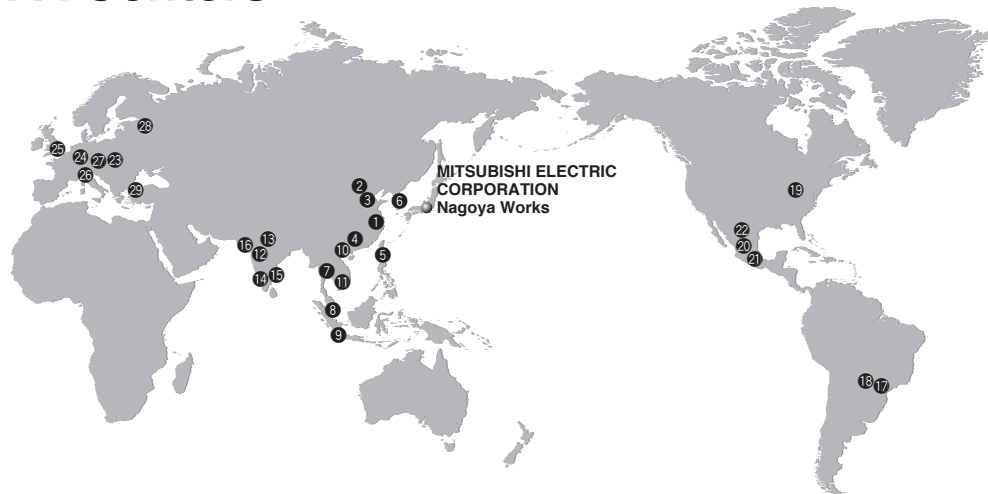

## China

### ① Shanghai FA Center Mitsubishi Electric Automation (China) Ltd. Shanghai FA Center

Mitsubishi Electric Automation Center, No.1386  
Hongqiao Road, Shanghai, China  
Tel: +86-21-2322-3030

### ② Beijing FA Center Mitsubishi Electric Automation (China) Ltd. Beijing FA Center

5/F, ONE INDIGO, 20 Jiuxianqiao Road  
Chaoyang District, Beijing, China  
Tel: +86-10-6518-8830

### ③ Tianjin FA Center Mitsubishi Electric Automation (China) Ltd. Tianjin FA Center

Room 2003 City Tower, No.35, Youyi Road, Hexi District,  
Tianjin, China  
Tel: +86-22-2813-1015

### ④ Guangzhou FA Center Mitsubishi Electric Automation (China) Ltd. Guangzhou FA Center

Room 1609, North Tower, The Hub Center, No.1068,  
Xingang East Road, Haizhu District, Guangzhou, China  
Tel: +86-20-8923-6730

## Taiwan

### ⑤ Taipei FA Center SETSUYO ENTERPRISE CO., LTD.

3F, No.105, Wugong 3rd Road, Wugu District,  
New Taipei City 24889, Taiwan  
Tel: +886-2-2299-9917

## Korea

### ⑥ Korea FA Center Mitsubishi Electric Automation Korea Co., Ltd.

8F, Gangseo Hangang Xi-tower A, 401, Yangcheon-ro,  
Gangseo-Gu, Seoul 07528, Korea  
Tel: +82-2-3660-9630

## Thailand

### ⑦ Thailand FA Center Mitsubishi Electric Factory Automation (Thailand) Co., Ltd.

12th Floor, SV.City Building, Office Tower 1, No. 896/19  
and 20 Rama 3 Road, Kwaeng Bangpongpan, Knet  
Yannawa, Bangkok 10120, Thailand  
Tel: +66-2682-6522 to 31

## ASEAN

### ⑧ ASEAN FA Center Mitsubishi Electric Asia Pte. Ltd.

307 Alexandra Road, Mitsubishi Electric Building,  
Singapore 159943  
Tel: +65-6470-2480

## Indonesia

### ⑨ Indonesia FA Center PT. Mitsubishi Electric Indonesia Cikarang Office

Jl. Kenari Raya Blok G2-07A Delta Silicon 5, Lippo  
Cikarang - Bekasi 17550, Indonesia  
Tel: +62-21-2961-7797

## Vietnam

### ⑩ Hanoi FA Center Mitsubishi Electric Vietnam Company Limited Hanoi Branch Office

6th Floor, Detech Tower, 8 Ton That Thuyet Street, My  
Dinh2 Ward, Nam Tu Liem District, Hanoi, Vietnam  
Tel: +84-4-3937-8075

### ⑪ Ho Chi Minh FA Center Mitsubishi Electric Vietnam Company Limited

Unit 01-04, 10th Floor, Vincom Center, 72 Le Thanh Ton  
Street, District 1, Ho Chi Minh City, Vietnam  
Tel: +84-8-3910-5945

## India

### ⑫ India Pune FA Center Mitsubishi Electric India Pvt. Ltd. Pune Branch

Emerald House, EL-3, J Block, M.I.D.C., Bhosari, Pune -  
411026, Maharashtra, India  
Tel: +91-20-2710-2000

### ⑬ India Gurgaon FA Center Mitsubishi Electric India Pvt. Ltd. Gurgaon Head Office

2nd Floor, Tower A & B, Cyber Greens, DLF Cyber City,  
DLF Phase - III, Gurgaon - 122002, Haryana, India  
Tel: +91-124-463-0300

### ⑭ India Bangalore FA Center Mitsubishi Electric India Pvt. Ltd. Bangalore Branch

Prestige Emerald, 6th Floor, Municipal No.2, Madras  
Bank Road, Bangalore - 560001, Karnataka, India  
Tel: +91-80-4020-1600

### ⑮ India Chennai FA Center Mitsubishi Electric India Pvt. Ltd. Chennai Branch

Citilights Corporate Centre No. 1, Vivekananda Road,  
Srinivasa Nagar, Chetpet, Chennai - 600031, Tamil  
Nadu, India  
Tel: +91-4445548772

### ⑯ India Ahmedabad FA Center Mitsubishi Electric India Pvt. Ltd. Ahmedabad Branch

B/4, 3rd Floor, SAFAL Profitaire, Corporate Road,  
Pralhadnagar, Satellite, Ahmedabad - 380015, Gujarat,  
India  
Tel: +91-7965120063

## Brazil

### ⑰ Brazil FA Center Mitsubishi Electric do Brasil Comercio e Servicos Ltda.

Avenida Adelino Cardana, 293, 21 andar, Bethaville,  
Barueri SP, Brazil  
Tel: +55-11-4689-3000

### ⑱ Brazil Votorantim FA Center MELCO CNC do Brasil Comercio e Servicos S.A.

Avenida Gisele Constantino,1578, Parque Bela  
Vista-Votorantim-SP, Brazil  
Tel: +55-15-3023-9000

## Americas

### ⑲ North America FA Center Mitsubishi Electric Automation, Inc.

500 Corporate Woods Parkway, Vernon Hills, IL 60061,  
U.S.A.  
Tel: +1-847-478-2100

### ⑳ Mexico City FA Center Mitsubishi Electric Automation, Inc. Mexico Branch

Mariano Escobedo #69, Col.Zona Industrial,  
Tlalnepanitla Edo. Mexico, C.P.54030  
Tel: +52-55-3067-7511

### ㉑ Mexico FA Center Mitsubishi Electric Automation, Inc. Queretaro Office

Parque Tecnologico Innovacion Queretaro Lateral  
Carretera Estatal 431, Km 2 200, Lote 91 Modulos  
1 y 2 Hacienda la Machorra, CP 76246, El Marques,  
Queretaro, Mexico  
Tel: +52-442-153-6014

### ㉒ Mexico Monterrey FA Center Mitsubishi Electric Automation, Inc. Monterrey Office

Plaza Mirage, Av. Gonzalitos 460 Sur, Local 28,  
Col. San Jeronimo, Monterrey, Nuevo Leon, C.P. 64640,  
Mexico  
Tel: +52-55-3067-7521

## Europe

### ㉓ Europe FA Center Mitsubishi Electric Europe B.V. Polish Branch

ul. Krakowska 48, 32-083 Balice, Poland  
Tel: +48-12-347-65-81

### ㉔ Germany FA Center Mitsubishi Electric Europe B.V. German Branch

Mitsubishi-Electric-Platz 1, 40882 Ratingen, Germany  
Tel: +49-2102-486-0

### ㉕ UK FA Center Mitsubishi Electric Europe B.V. UK Branch

Travellers Lane, Hatfield, Hertfordshire, AL10 8XB, U.K.  
Tel: +44-1707-27-8780

### ㉖ Italy FA Center Mitsubishi Electric Europe B.V. Italian Branch

Centro Direzionale Colleoni - Palazzo Sirio,  
Viale Colleoni 7, 20864 Agrate Brianza (MB), Italy  
Tel: +39-039-60531

### ㉗ Czech Republic FA Center Mitsubishi Electric Europe B.V. Czech Branch

Pekarska 621/7, 155 00 Praha 5, Czech Republic  
Tel: +420-255 719 200

### ㉘ Russia FA Center Mitsubishi Electric (Russia) LLC St. Petersburg Branch

Piskarevsky pr. 2, bld 2, lit "Sch", BC "Benua", office  
720; 195027, St. Petersburg, Russia  
Tel: +7-812-633-3497

### ㉙ Turkey FA Center Mitsubishi Electric Turkey A.S. Umraniye Branch

Serifali Mahallesi Nutuk Sokak No:5, TR-34775  
Umraniye / Istanbul, Turkey  
Tel: +90-216-526-3990

## List of Instruction Manuals

Instruction Manuals for MELSERVO-JE series are listed below:

### Servo Amplifier

Manual name	Manual No.
MR-JE-_C Servo Amplifier Instruction Manual	SH-030257ENG
MR-JE-_C Servo Amplifier Instruction Manual (Profile Mode)	SH-030254ENG
MR-JE-_C Servo Amplifier Instruction Manual (Network)	SH-030256ENG
MR-JE-_C Servo Amplifier Instruction Manual (Positioning Mode)	SH-030277ENG
MR-JE-_B Servo Amplifier Instruction Manual	SH-030152ENG
MR-JE-_A Servo Amplifier Instruction Manual	SH-030128ENG
MR-JE-_A Servo Amplifier Instruction Manual (Positioning Mode)	SH-030150ENG
MR-JE-_A Servo Amplifier Instruction Manual (Modbus RTU Protocol)	SH-030177ENG
MELSERVO-JE Servo amplifier Instruction Manual (Trouble Shooting)	SH-030166ENG

### Servo Motor

Manual name	Manual No.
HG-KN/HG-SN Servo Motor Instruction Manual	SH-030135ENG

### Others

Manual name	Manual No.
EMC Installation Guidelines	IB-67310

Microsoft, Windows, Internet Explorer, and Windows Vista are either registered trademarks or trademarks of Microsoft Corporation in the United States and/or other countries.

Celeron and Pentium are registered trademarks or trademarks of Intel Corporation in the U.S. and/or other countries.

Ethernet is a trademark of Xerox Corporation.

All other company names and product names used in this document are trademarks or registered trademarks of their respective companies.



### Safety Warning

To ensure proper use of the products listed in this catalog, please be sure to read the instruction manual prior to use.

# YOUR SOLUTION PARTNER

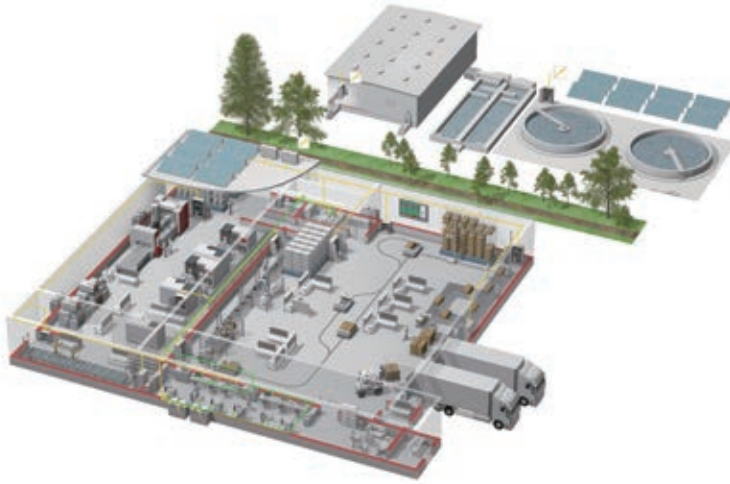

Mitsubishi Electric offers a wide range of automation equipment from PLCs and HMIs to CNC and EDM machines.

## A NAME TO TRUST

Since its beginnings in 1870, some 45 companies use the Mitsubishi name, covering a spectrum of finance, commerce and industry.

The Mitsubishi brand name is recognized around the world as a symbol of premium quality.

Mitsubishi Electric Corporation is active in space development, transportation, semi-conductors, energy systems, communications and information processing, audio visual equipment and home electronics, building and energy management and automation systems, and has 237 factories and laboratories worldwide in over 121 countries.

This is why you can rely on Mitsubishi Electric automation solution - because we know first hand about the need for reliable, efficient, easy-to-use automation and control in our own factories.

As one of the world's leading companies with a global turnover of over 4 trillion Yen (over \$40 billion), employing over 100,000 people, Mitsubishi Electric has the resource and the commitment to deliver the ultimate in service and support as well as the best products.



Low voltage: MCCB, MCB, ACB



Medium voltage: VCB, VCC



Power monitoring, energy management



Compact and Modular Controllers



Inverters, Servos and Motors



Visualisation: HMIs



Numerical Control (NC)



Robots: SCARA, Articulated arm



Processing machines: EDM, Lasers, IDS



Transformers, Air conditioning, Photovoltaic systems

\* Not all products are available in all countries.

# SERVO AMPLIFIERS & MOTORS

Country/Region	Sales office	Tel
USA	Mitsubishi Electric Automation, Inc. 500 Corporate Woods Parkway, Vernon Hills, IL 60061, U.S.A.	Tel : +1-847-478-2100
Mexico	Mitsubishi Electric Automation, Inc. Mexico Branch Boulevard Miguel de Cervantes Saavedra 301, Torre Norte Piso 5, Ampliacion Granada, Miguel Hidalgo, Ciudad de Mexico, Mexico, C.P.11520	Tel : +52-55-3067-7512
Brazil	Mitsubishi Electric do Brasil Comercio e Servicos Ltda. Avenida Adelino Cardana, 293, 21 andar, Bethaville, Barueri SP, Brazil	Tel : +55-11-4689-3000
Germany	Mitsubishi Electric Europe B.V. German Branch Mitsubishi-Electric-Platz 1, 40882 Ratingen, Germany	Tel : +49-2102-486-0
UK	Mitsubishi Electric Europe B.V. UK Branch Travellers Lane, UK-Hatfield, Hertfordshire, AL10 8XB, U.K.	Tel : +44-1707-28-8780
Italy	Mitsubishi Electric Europe B.V. Italian Branch Centro Direzionale Colleoni - Palazzo Sirio, Viale Colleoni 7, 20864 Agrate Brianza (MB), Italy	Tel : +39-039-60531
Spain	Mitsubishi Electric Europe B.V. Spanish Branch Carretera de Rubi, 76-80-Apdo. 420, E-08190 Sant Cugat del Valles (Barcelona), Spain	Tel : +34-935-65-3131
France	Mitsubishi Electric Europe B.V. French Branch 25, Boulevard des Bouvets, 92741 Nanterre Cedex, France	Tel : +33-1-55-68-55-68
Czech Republic	Mitsubishi Electric Europe B.V. Czech Branch, Prague Office Pekarska 621/7, 155 00 Praha 5, Czech Republic	Tel : +420-255-719-200
Poland	Mitsubishi Electric Europe B.V. Polish Branch ul. Krakowska 50, 32-083 Balice, Poland	Tel : +48-12-347-65-00
Russia	Mitsubishi Electric (Russia) LLC St. Petersburg Branch Piskarevsky pr. 2, bld 2, lit "Sch", BC "Benua", office 720; 195027 St. Petersburg, Russia	Tel : +7-812-633-3497
Sweden	Mitsubishi Electric Europe B.V. (Scandinavia) Fjellievagen 8, SE-22736 Lund, Sweden	Tel : +46-8-625-10-00
Turkey	Mitsubishi Electric Turkey A.S. Umraniye Branch Serifali Mahallesi Nutuk Sokak No:5, TR-34775 Umraniye / Istanbul, Turkey	Tel : +90-216-526-3990
UAE	Mitsubishi Electric Europe B.V. Dubai Branch Dubai Silicon Oasis, P.O.BOX 341241, Dubai, U.A.E.	Tel : +971-4-3724716
South Africa	Adroit Technologies 20 Waterford Office Park, 189 Witkoppen Road, Fourways, South Africa	Tel : +27-11-658-8100
China	Mitsubishi Electric Automation (China) Ltd. Mitsubishi Electric Automation Center, No.1386 Hongqiao Road, Shanghai, China	Tel : +86-21-2322-3030
Taiwan	SETSUYO ENTERPRISE CO., LTD. 6F, No.105, Wugong 3rd Road, Wugu District, New Taipei City 24889, Taiwan	Tel : +886-2-2299-2499
Korea	Mitsubishi Electric Automation Korea Co., Ltd. 7F to 9F, Gangseo Hangang Xi-tower A, 401, Yangcheon-ro, Gangseo-Gu, Seoul 07528, Korea	Tel : +82-2-3660-9529
Singapore	Mitsubishi Electric Asia Pte. Ltd. 307 Alexandra Road, Mitsubishi Electric Building, Singapore 159943	Tel : +65-6473-2308
Thailand	Mitsubishi Electric Factory Automation (Thailand) Co., Ltd. 12th Floor, SV.City Building, Office Tower 1, No. 896/19 and 20 Rama 3 Road, Kwaeng Bangpongpan, Khet Yannawa, Bangkok 10120, Thailand	Tel : +66-2682-6522 to 6531
Indonesia	PT. Mitsubishi Electric Indonesia Gedung Jaya 8th Floor, JL. MH. Thamrin No.12, Jakarta Pusat 10340, Indonesia	Tel : +62-21-3192-6461
Vietnam	Mitsubishi Electric Vietnam Company Limited Unit 01-04, 10th Floor, Vincom Center, 72 Le Thanh Ton Street, District 1, Ho Chi Minh City, Vietnam	Tel : +84-28-3910-5945
India	Mitsubishi Electric India Pvt. Ltd. Pune Branch Emerald House, EL-3, J Block, M.I.D.C., Bhosari, Pune - 411026, Maharashtra, India	Tel : +91-20-2710-2000
Australia	Mitsubishi Electric Australia Pty. Ltd. 348 Victoria Road, P.O. Box 11, Rydalmere, N.S.W 2116, Australia	Tel : +61-2-9684-7777

Mitsubishi Electric Corporation Nagoya Works is a factory certified for ISO14001 (standards for environmental management systems) and ISO9001(standards for quality assurance management systems)

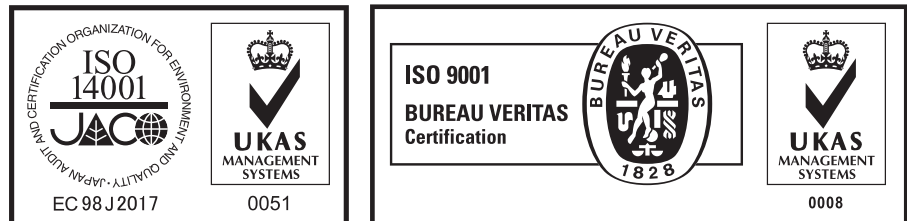

## MITSUBISHI ELECTRIC CORPORATION

HEAD OFFICE: TOKYO BUILDING, 2-7-3, MARUNOUCHI, CHIYODA-KU, TOKYO 100-8310, JAPAN  
NAGOYA WORKS: 1-14, YADA-MINAMI 5, HIGASHI-KU, NAGOYA, JAPAN